



US00D445293S

(12) **United States Design Patent**
Lillelund et al.

(10) **Patent No.: US D445,293 S**

(45) **Date of Patent: ** Jul. 24, 2001**

(54) **PITCHER WITH LID**

(75) Inventors: **Stig Lillelund**, Gentofte; **Jakob Heiberg**, Charlottenlund; **Hanne Dalsgaard Jeppesen**, Holte, all of (DK); **Robert H. C. M. Daenen**, Herne (BE)

(73) Assignee: **Dart Industries Inc.**, Orlando, FL (US)

(**) Term: **14 Years**

(21) Appl. No.: **29/126,860**

(22) Filed: **Jul. 25, 2000**

(51) **LOC (7) Cl. 07-01**

(52) **U.S. Cl. D7/319; D7/317**

(58) **Field of Search** D7/300, 312, 316, D7/317, 318, 319; 222/475.1, 465.1, 572, 478, 144.5; 210/282, 470, 237

(56) **References Cited**

U.S. PATENT DOCUMENTS

D. 154,348	6/1949	Tupper .	
D. 180,049	4/1957	Tupper .	
D. 187,247	2/1960	Tupper .	
D. 192,192	2/1962	Tupper .	
D. 194,622	2/1963	Swett .	
D. 227,142	6/1973	Swett et al. .	
D. 255,531	6/1980	Daenen et al. .	
D. 257,312	10/1980	Conti .	
D. 270,602	9/1983	Fritz .	
D. 272,225	1/1984	De Coster .	
D. 283,002	3/1986	Daenen .	
D. 283,193	4/1986	Daenen .	
D. 287,325	12/1986	Schmidt .	
D. 303,904	* 10/1989	Wolfenden	D7/317
D. 306,547	* 3/1990	Wolfenden	D7/317
D. 310,614	9/1990	Pozzi .	
D. 312,551	12/1990	DeCoster .	
D. 316,206	4/1991	Daenen et al. .	
D. 319,368	8/1991	Picozza et al. .	
D. 321,301	* 11/1991	Purkapile	D7/376
D. 323,093	* 1/1992	Picozza et al.	D7/319
D. 338,367	* 8/1993	Fonville	D7/317
D. 338,591	* 8/1993	Wyatt et al.	D7/318

D. 339,023	9/1993	De Coster .	
D. 350,255	9/1994	Daenen et al. .	
D. 356,004	3/1995	Van Valkenburg et al. .	
D. 364,990	12/1995	Fonville .	
D. 365,963	* 1/1996	Feer	D7/321
D. 367,580	* 3/1996	Joergensen	D7/318
D. 368,404	* 4/1996	Zive	D7/318
D. 375,866	11/1996	Wai	D7/319
D. 379,732	6/1997	Jeppesen et al.	D7/319
D. 382,763	* 8/1997	Jeppesen et al.	D7/316
D. 382,769	8/1997	Jeppesen et al.	D7/392.1
D. 383,351	* 9/1997	DeMore	D7/319
D. 389,006	1/1998	Demore et al.	D7/319
D. 392,149	* 3/1998	Smith	D7/307
D. 395,784	* 7/1998	Michaeli	D7/319
D. 398,184	9/1998	Silverberg et al.	D7/319
D. 398,474	* 9/1998	Wagner	D7/305
D. 415,922	* 11/1999	Kawasaki et al.	D7/317
D. 416,163	* 11/1999	Doritty et al.	D7/319
D. 436,790	* 1/2001	Saltet	D7/319
D. 437,175	* 2/2001	Brady	D7/319
D. 439,790	* 4/2001	Mutsushita et al.	D7/319
D. 440,110	* 4/2001	Tanner et al.	D7/319
D. 441,237	* 5/2001	Beam	D7/305
3,512,686	5/1970	Penniman .	
4,623,457	* 11/1986	Hankammer	210/237
5,161,711	11/1992	Picozza et al. .	

* cited by examiner

Primary Examiner—M. N. Pandozzi
(74) *Attorney, Agent, or Firm*—Taylor J. Ross

(57) **CLAIM**

The ornamental design for a pitcher with lid, as shown and described.

DESCRIPTION

FIG. 1 is a top, side and front perspective view of a pitcher with lid showing the new design;
FIG. 2 is a right side elevation view thereof;
FIG. 3 is a left side elevation view thereof;
FIG. 4 is a front elevation view thereof;
FIG. 5 is a rear elevation view thereof;
FIG. 6 is a top plan view thereof; and,
FIG. 7 is a bottom plan view thereof.

1 Claim, 3 Drawing Sheets

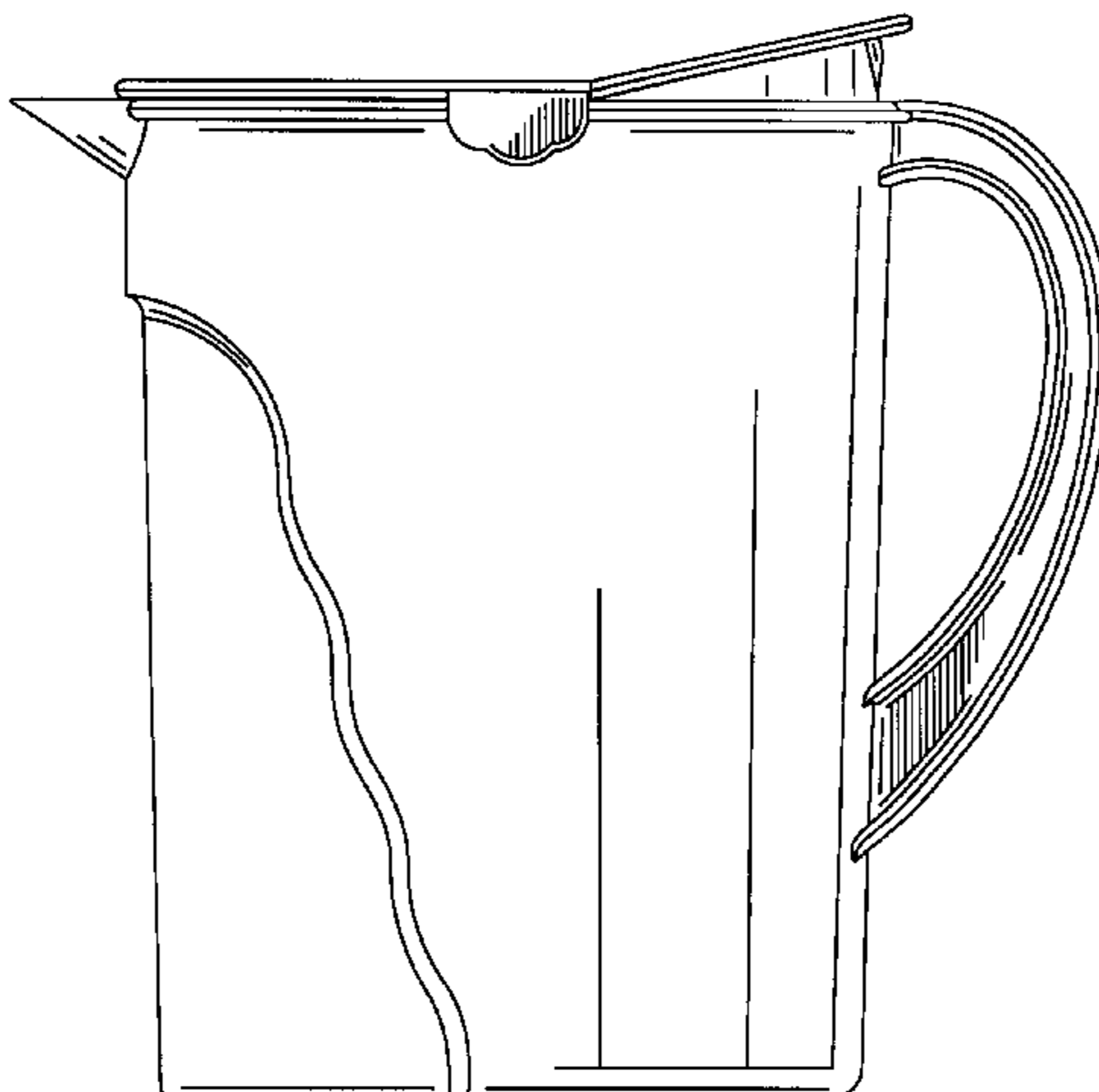

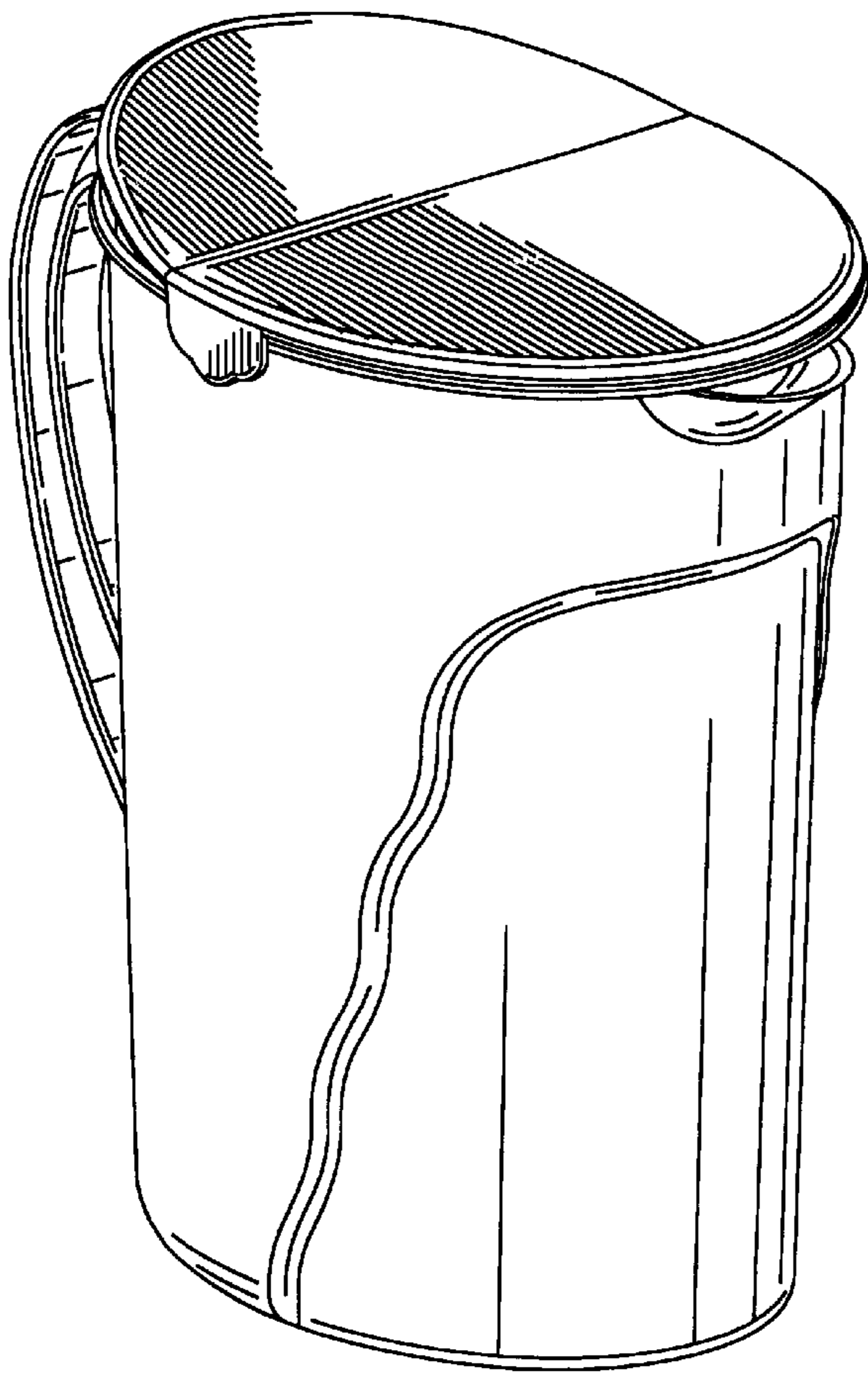

FIG. 1

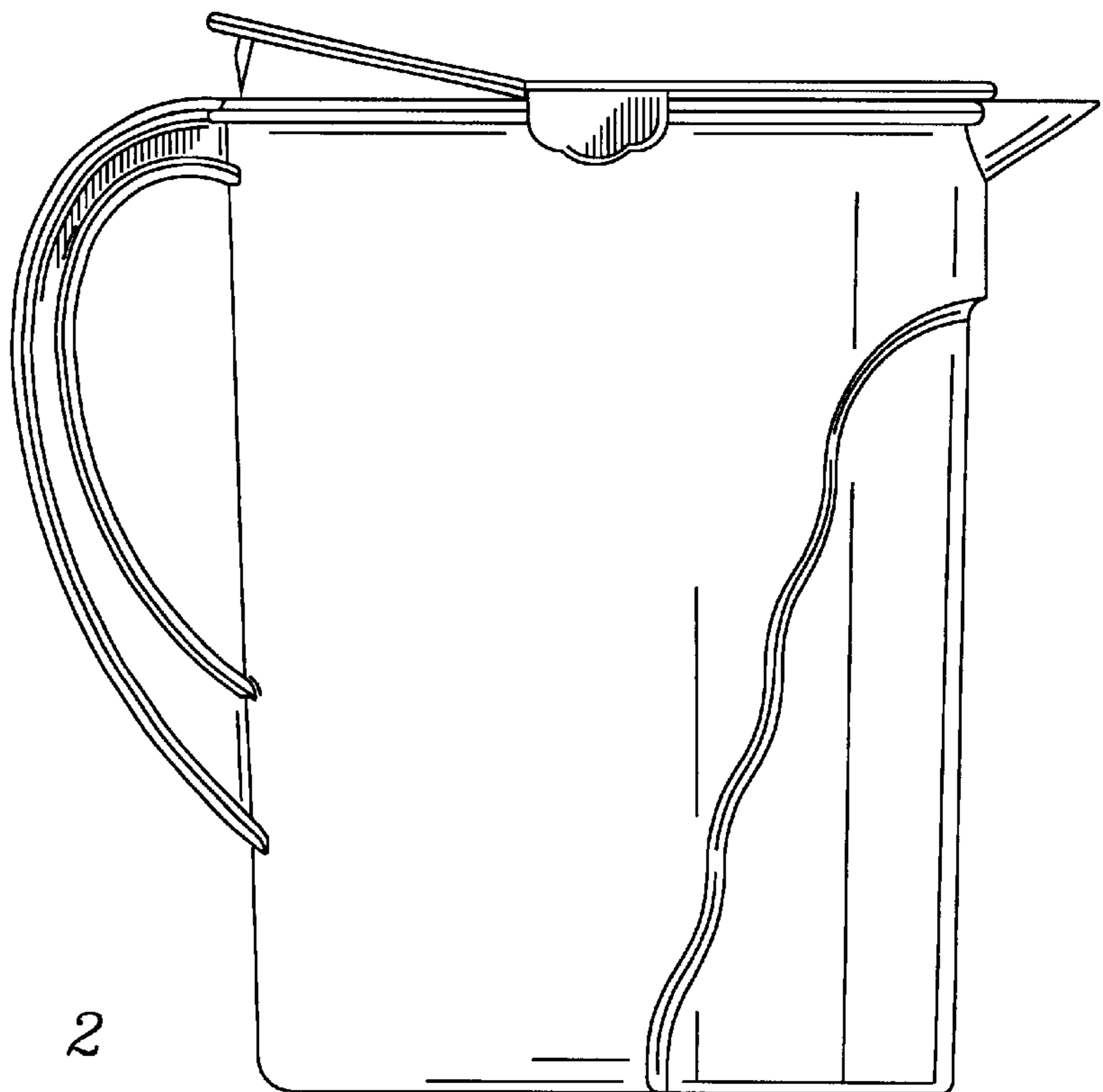

FIG. 2

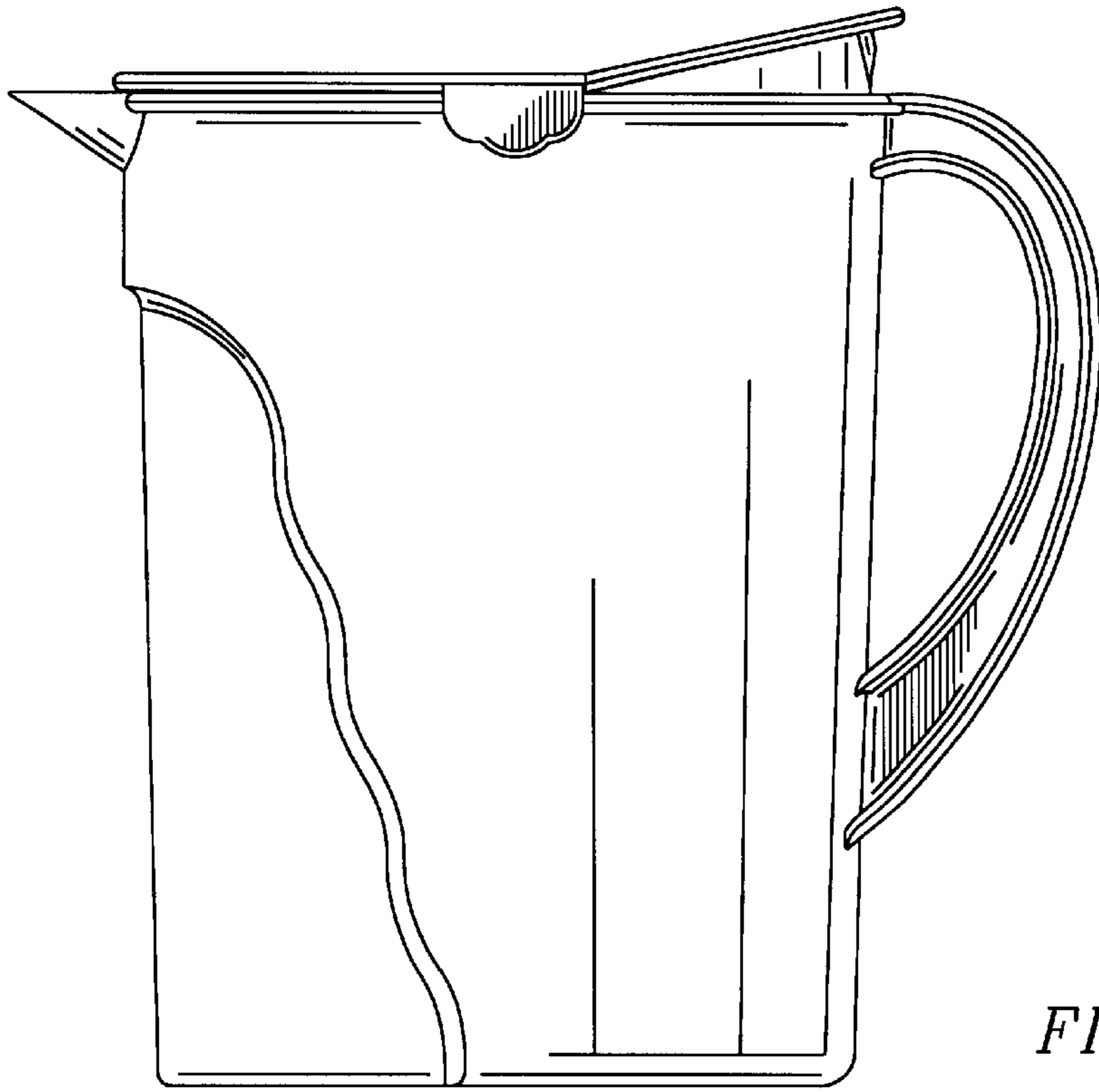

FIG. 3

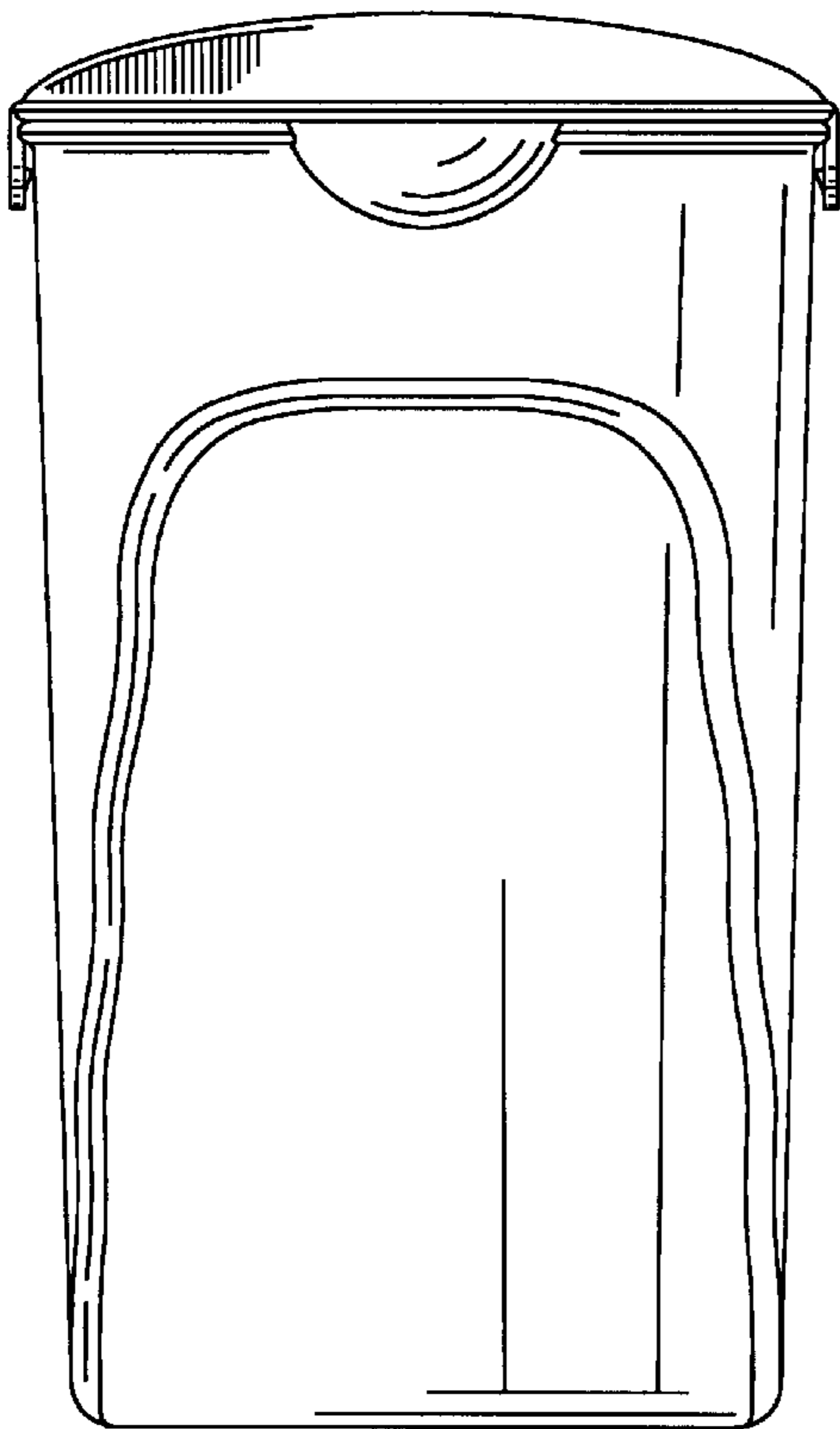

FIG. 4

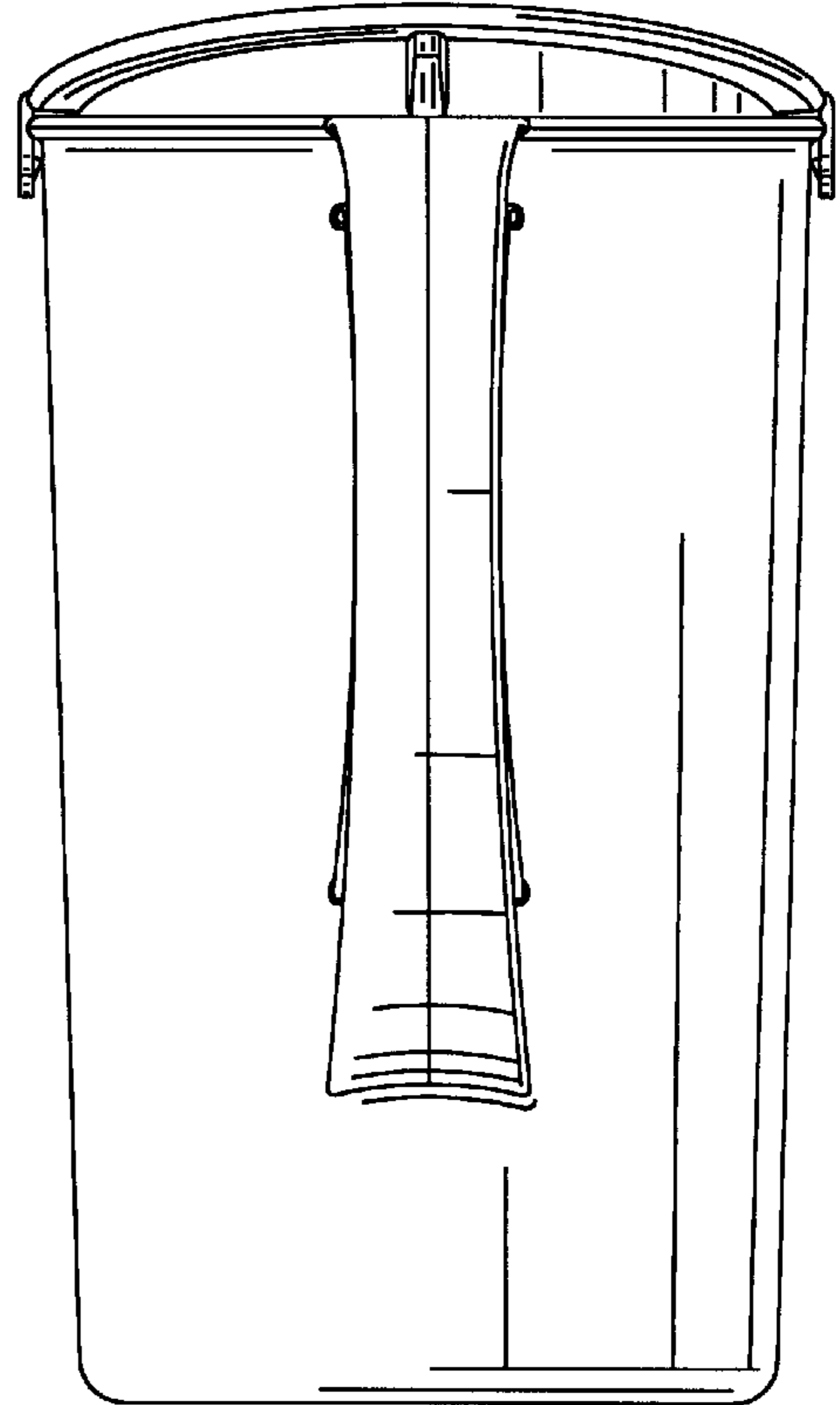

FIG. 5

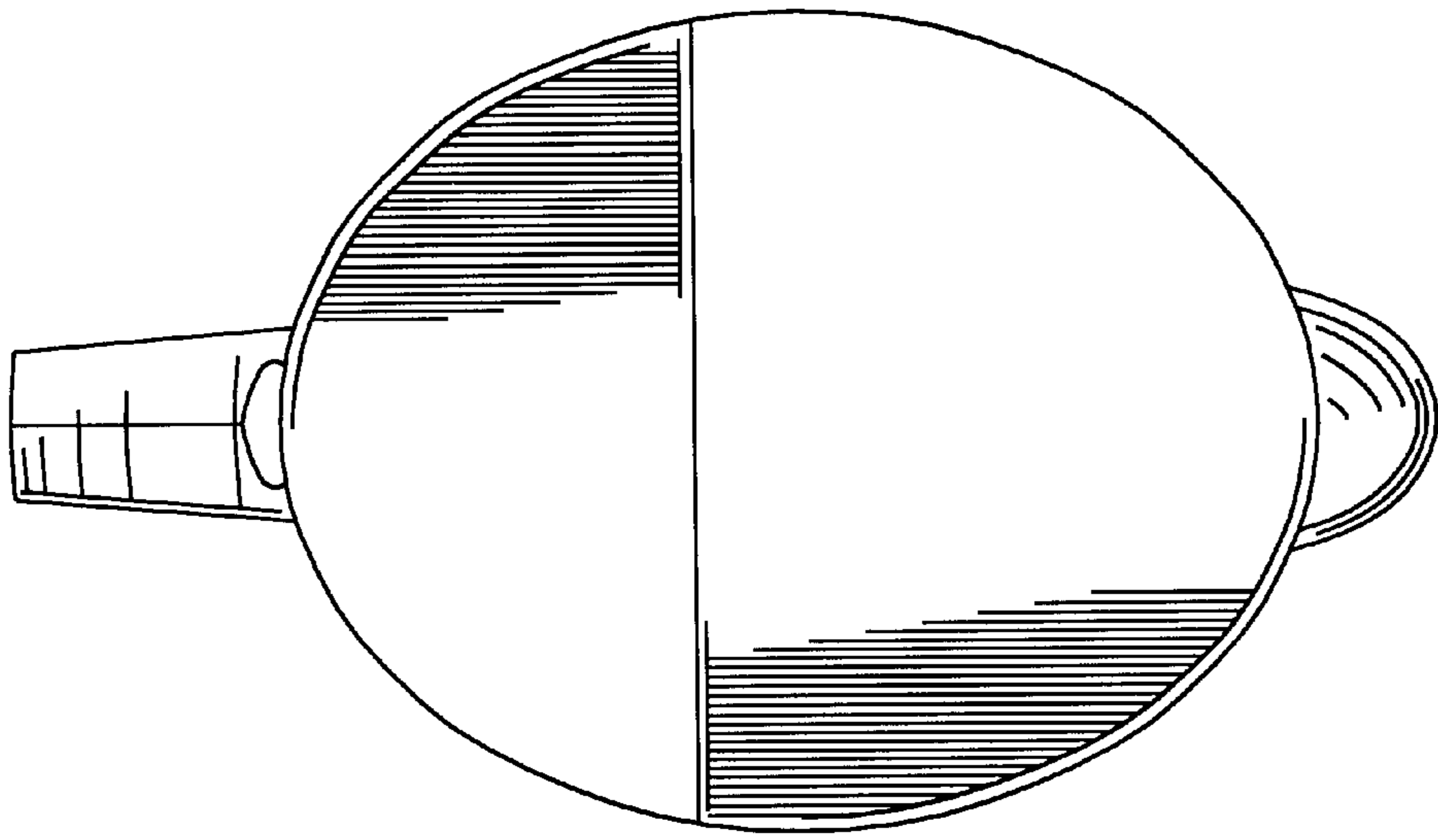

FIG. 6

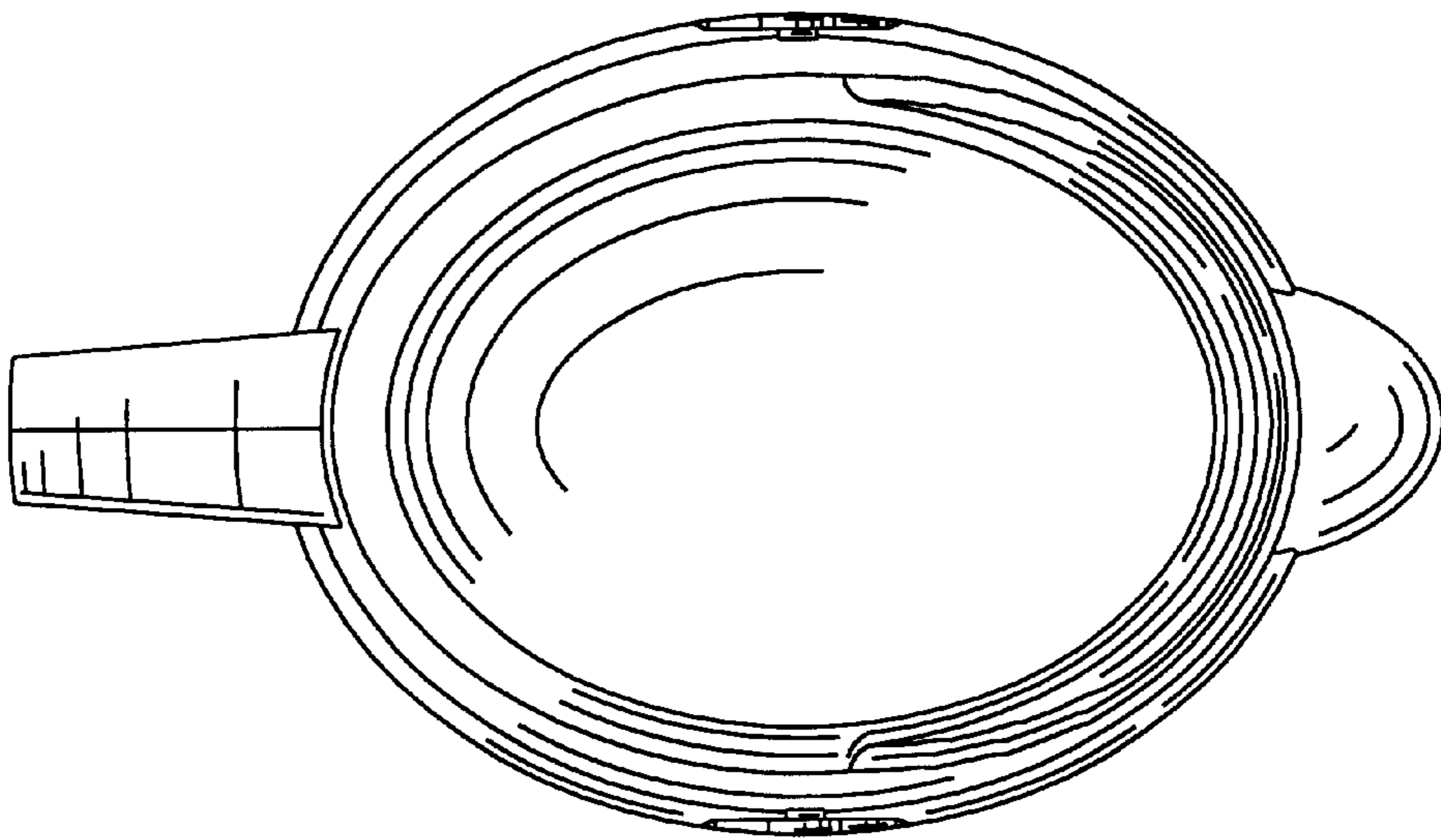

FIG. 7