



US00D444930S

(12) **United States Design Patent**
Brown

(10) **Patent No.:** **US D444,930 S**

(45) **Date of Patent:** **** Jul. 10, 2001**

(54) **DISPLAY AND STORAGE CASE HAVING
HINGED LID WITH FALSE
DRAWERFRONTS**

Primary Examiner—Kay H. Chin
(74) *Attorney, Agent, or Firm—Burkhart & Burkhart; Anne
K. Burkhart; Patrick N. Burkhart*

(76) **Inventor:** **Carl E. Brown**, 624 Honey House La.,
Corvallis, MT (US) 59828

(57) **CLAIM**

(**) **Term:** **14 Years**

The ornamental design for a display and storage case having
hinged lid with false drawerfronts, as shown and described.

(21) **Appl. No.:** **29/122,780**

DESCRIPTION

(22) **Filed:** **May 1, 2000**

FIG. 1 is a front perspective view of a display and storage
case according to my invention;

(51) **LOC (7) Cl.** **12-02**

(52) **U.S. Cl.** **D34/19; D34/12**

FIG. 2 is a front perspective view of a display and storage
case according to my invention with the hinged lid in its
open position;

(58) **Field of Search** D34/12-27; D6/432,
D6/445, 446, 448; 280/47.35; 312/250;
D8/300, 315, 316, 317

FIG. 3 is a right side elevational view of a display and
storage case according to my invention;

(56) **References Cited**

U.S. PATENT DOCUMENTS

D. 273,906 * 5/1984 Norlin D34/19

D. 283,263 * 4/1986 Richey D34/19

D. 427,807 * 7/2000 Holcomb et al. D6/445

FIG. 4 is a left side elevational view thereof;

FIG. 5 is a front elevational view thereof;

FIG. 6 is a rear elevational view thereof

FIG. 7 is a top plan view thereof; and,

FIG. 8 is a bottom plan view thereof.

* cited by examiner

1 Claim, 7 Drawing Sheets

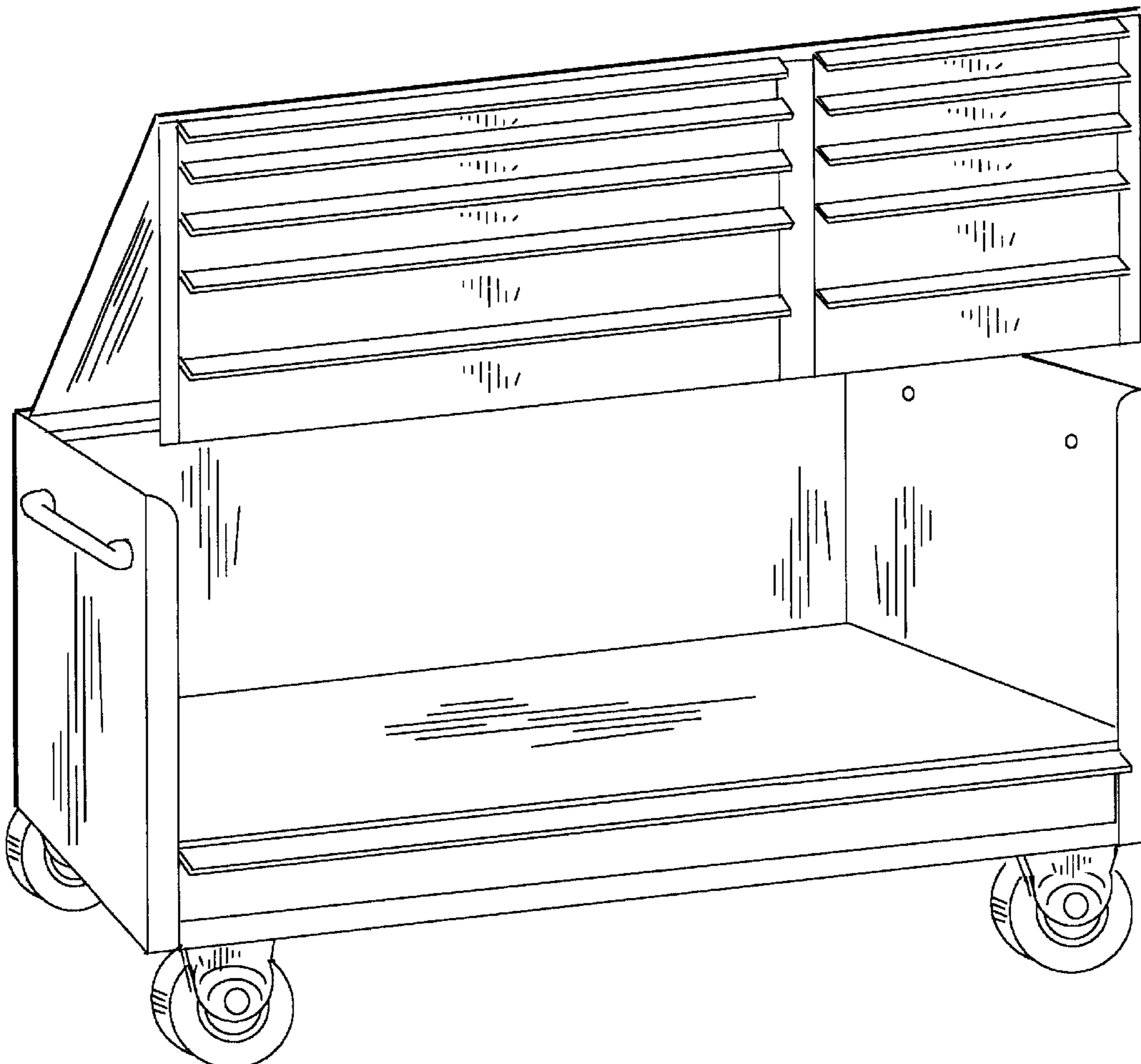

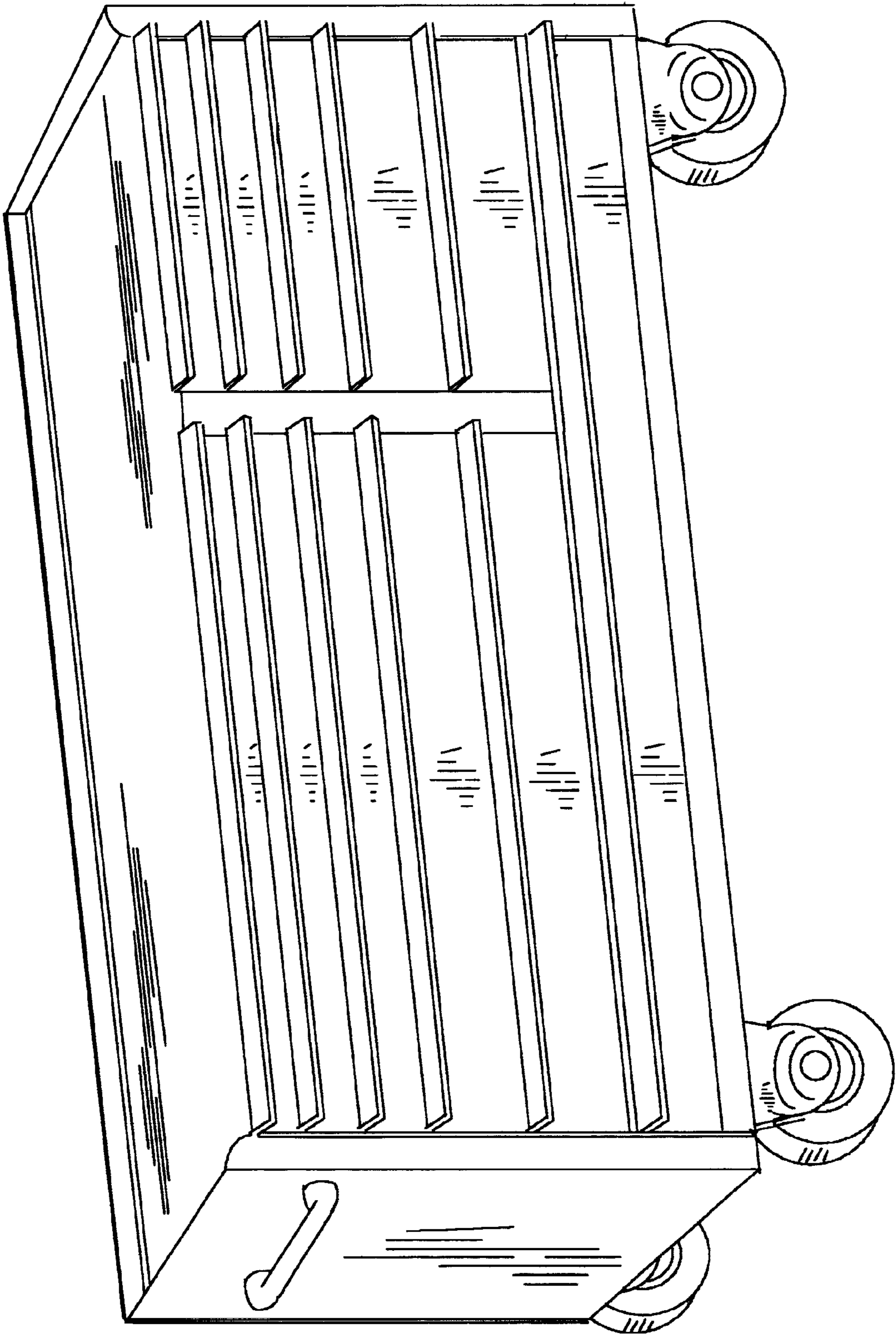

FIG. 1

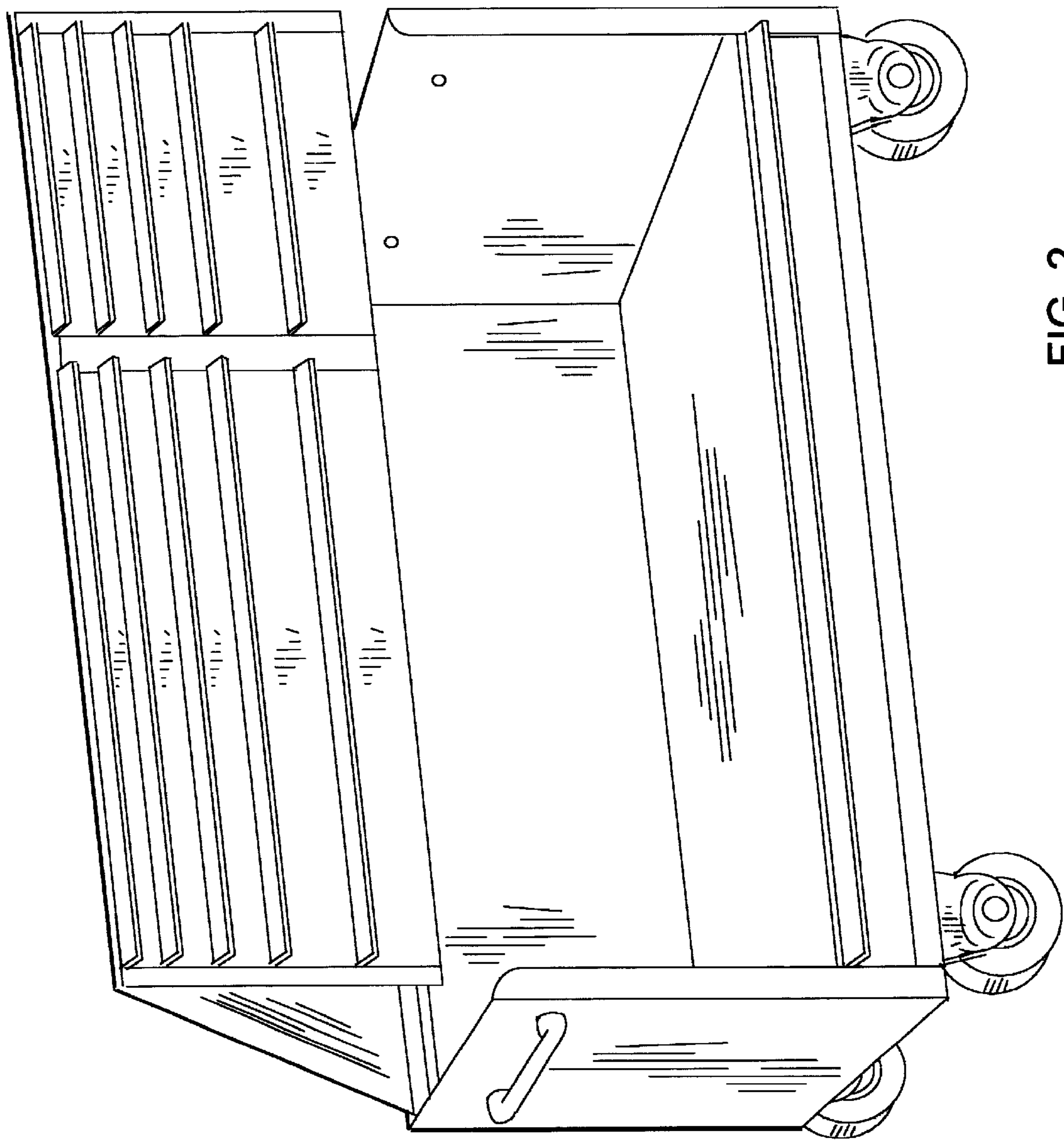

FIG. 2

FIG. 3

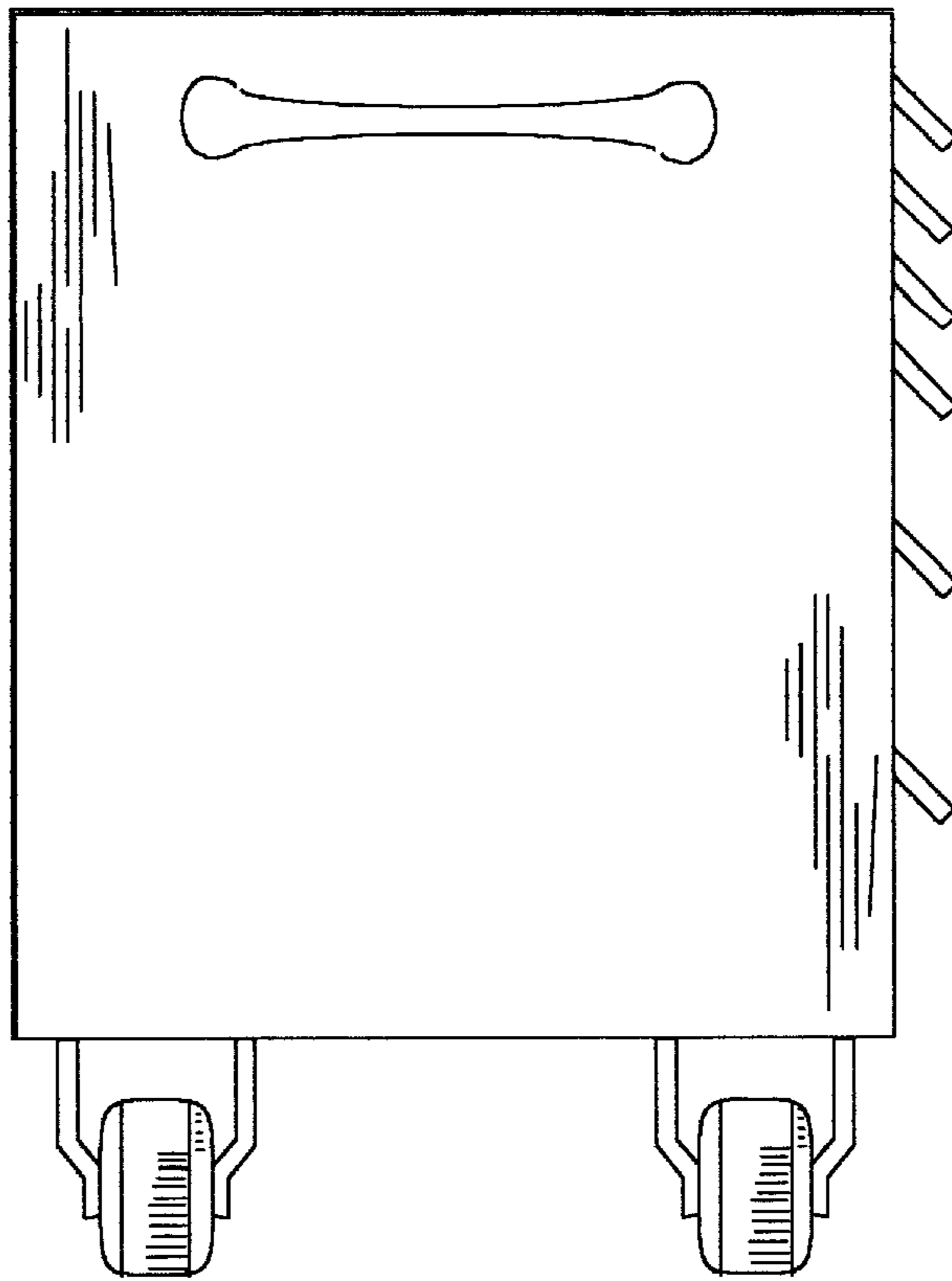
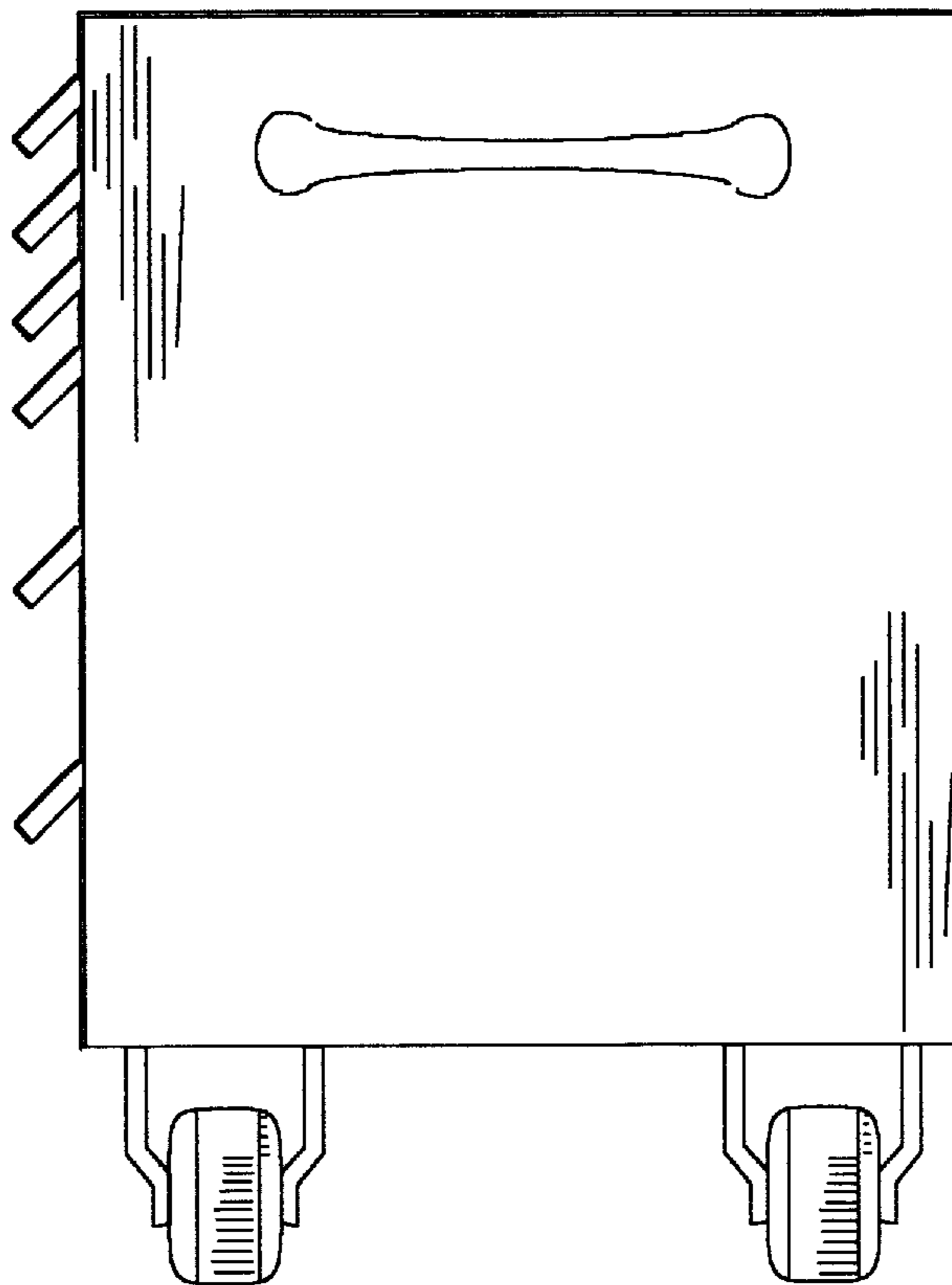

FIG. 4



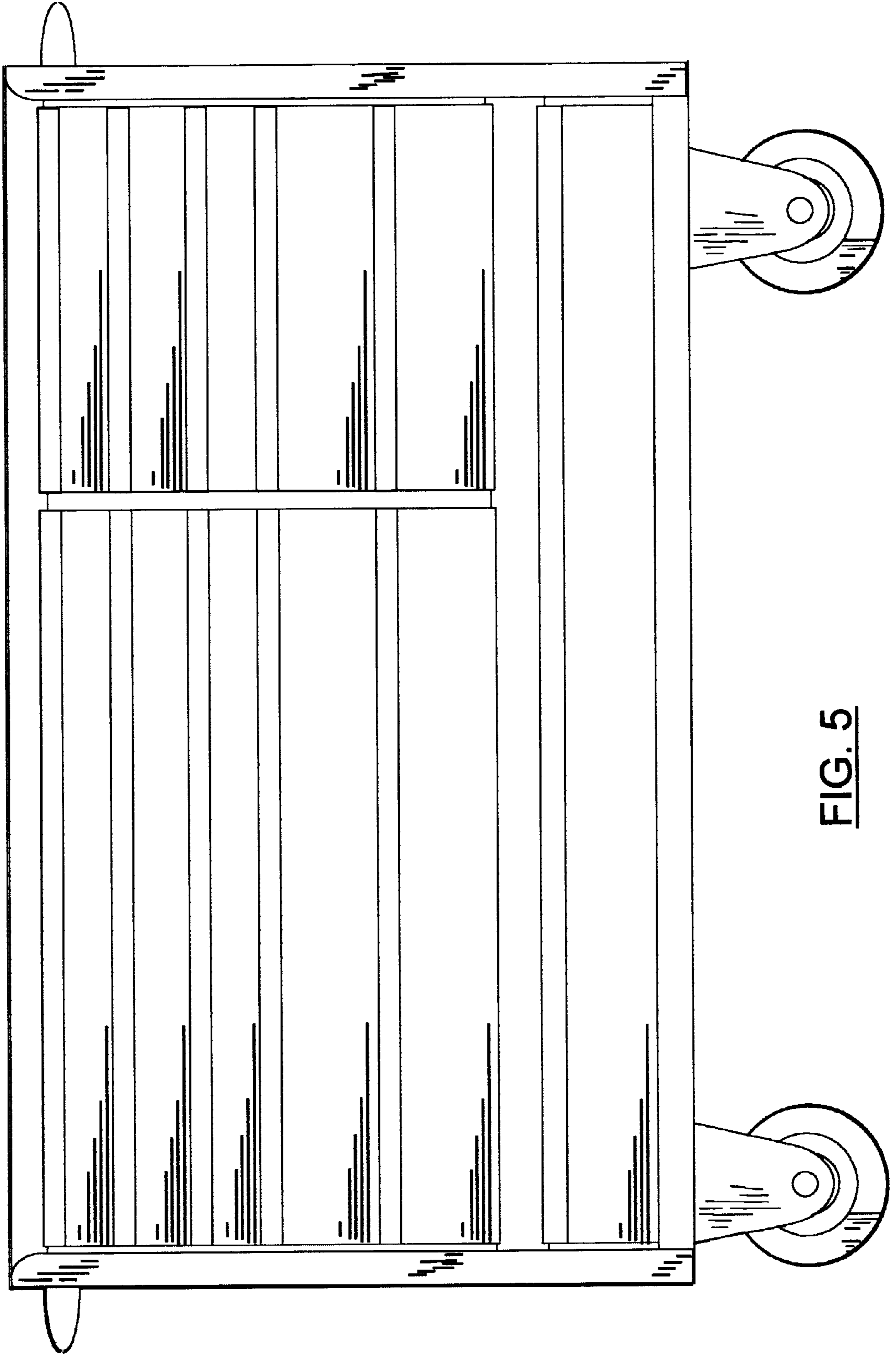

FIG. 5

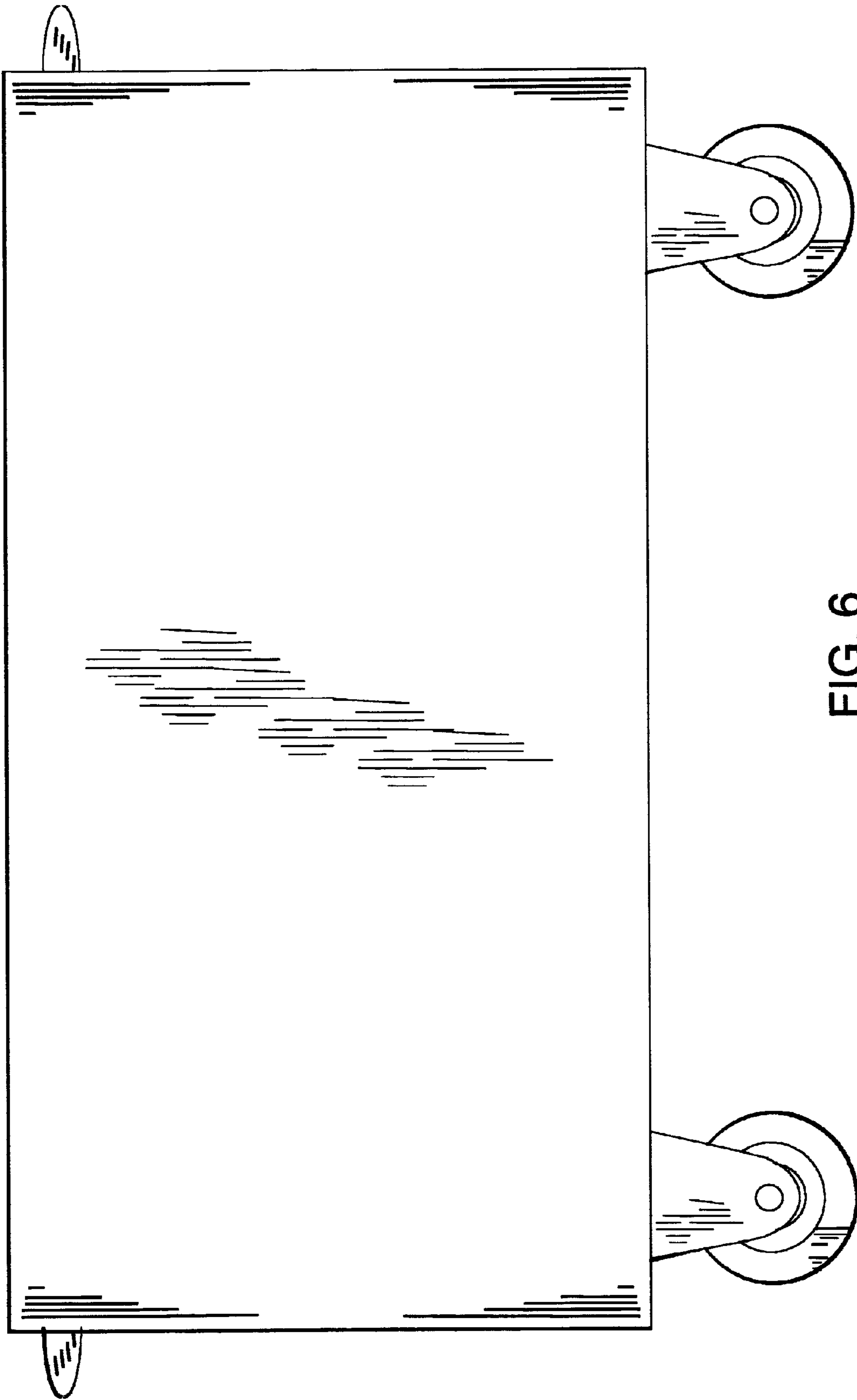

FIG. 6

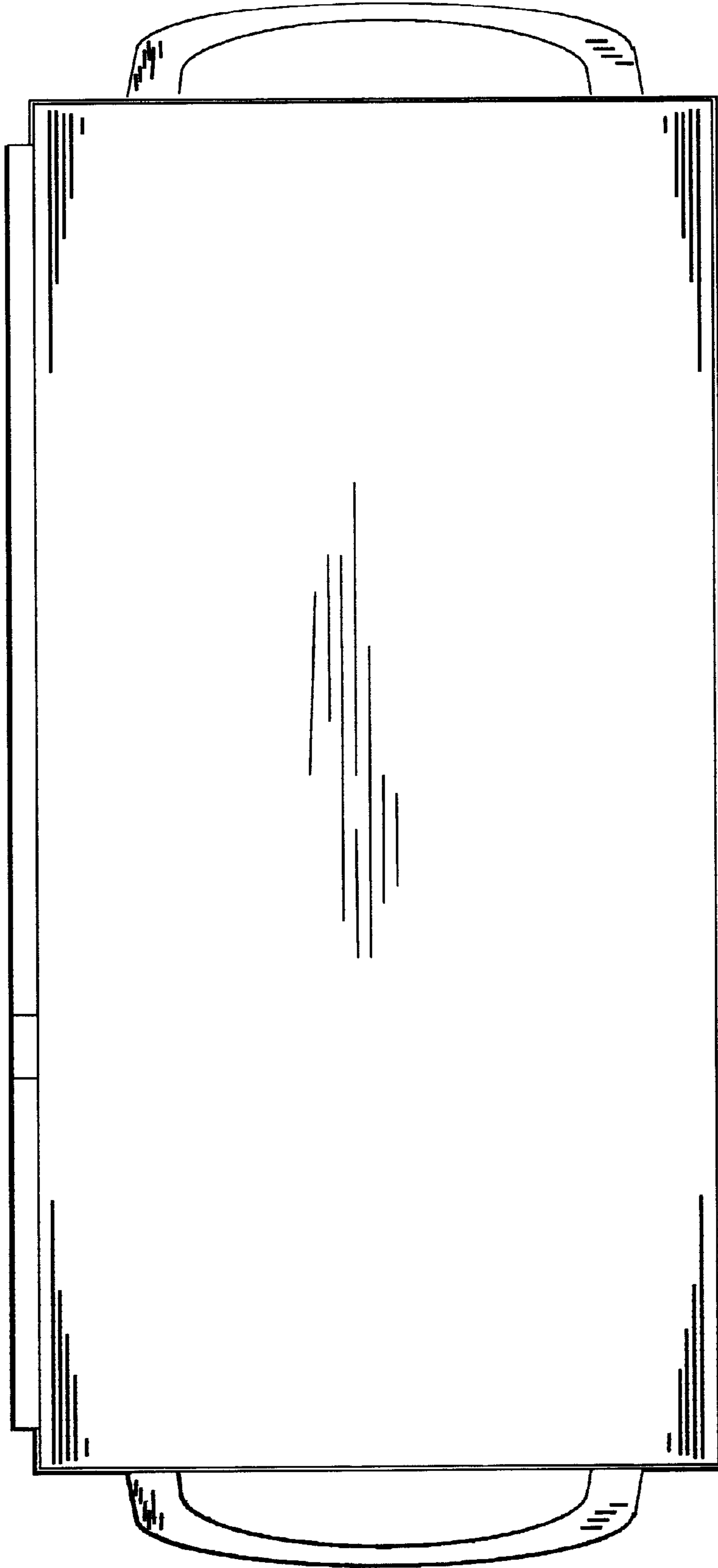

FIG. 7

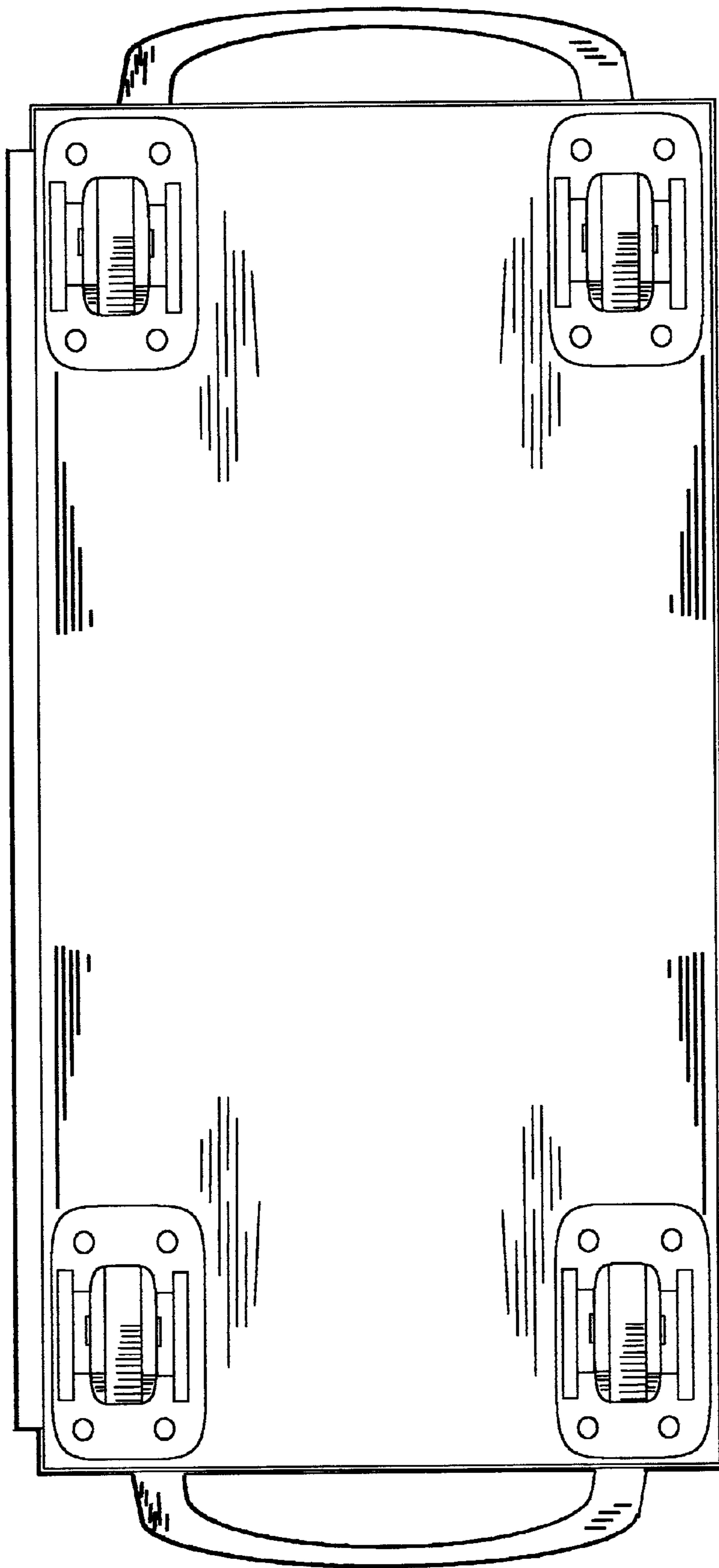

FIG. 8