



US00D444729S

(12) **United States Design Patent**
Lin

(10) **Patent No.:** **US D444,729 S**

(45) **Date of Patent:** **** Jul. 10, 2001**

(54) **BELL**

D. 395,615 * 6/1998 Lin D10/116

(76) **Inventor:** **Shen-Keng Lin**, No. 387-16, Fan-Hua Rd., Hsiao-Shiu Hsiang, Changhua Hsien (TW)

* cited by examiner

Primary Examiner—Marcus A. Jackson
(74) *Attorney, Agent, or Firm*—Baker Botts L.L.P.

(**) **Term:** **14 Years**

(57) **CLAIM**

(21) **Appl. No.:** **29/132,120**

The ornamental design for bell, as shown and described.

(22) **Filed:** **Nov. 3, 2000**

DESCRIPTION

(51) **LOC (7) Cl.** **10-05**

(52) **U.S. Cl.** **D10/116**

(58) **Field of Search** D10/104, 116,
D10/118, 119, 120, 121; 340/425.5, 427,
428, 432; 116/148–158

FIG. 1 is a perspective view of bell showing my new design;
FIG. 2 is a front elevational view thereof;
FIG. 3 is a rear elevational view thereof;
FIG. 4 is a left side elevational view thereof;
FIG. 5 is a right side elevational view thereof;
FIG. 6 is a top plan view thereof; and,
FIG. 7 is a bottom plan view thereof.

(56) **References Cited**

U.S. PATENT DOCUMENTS

D. 360,159 * 7/1995 Moore D10/116

1 Claim, 4 Drawing Sheets

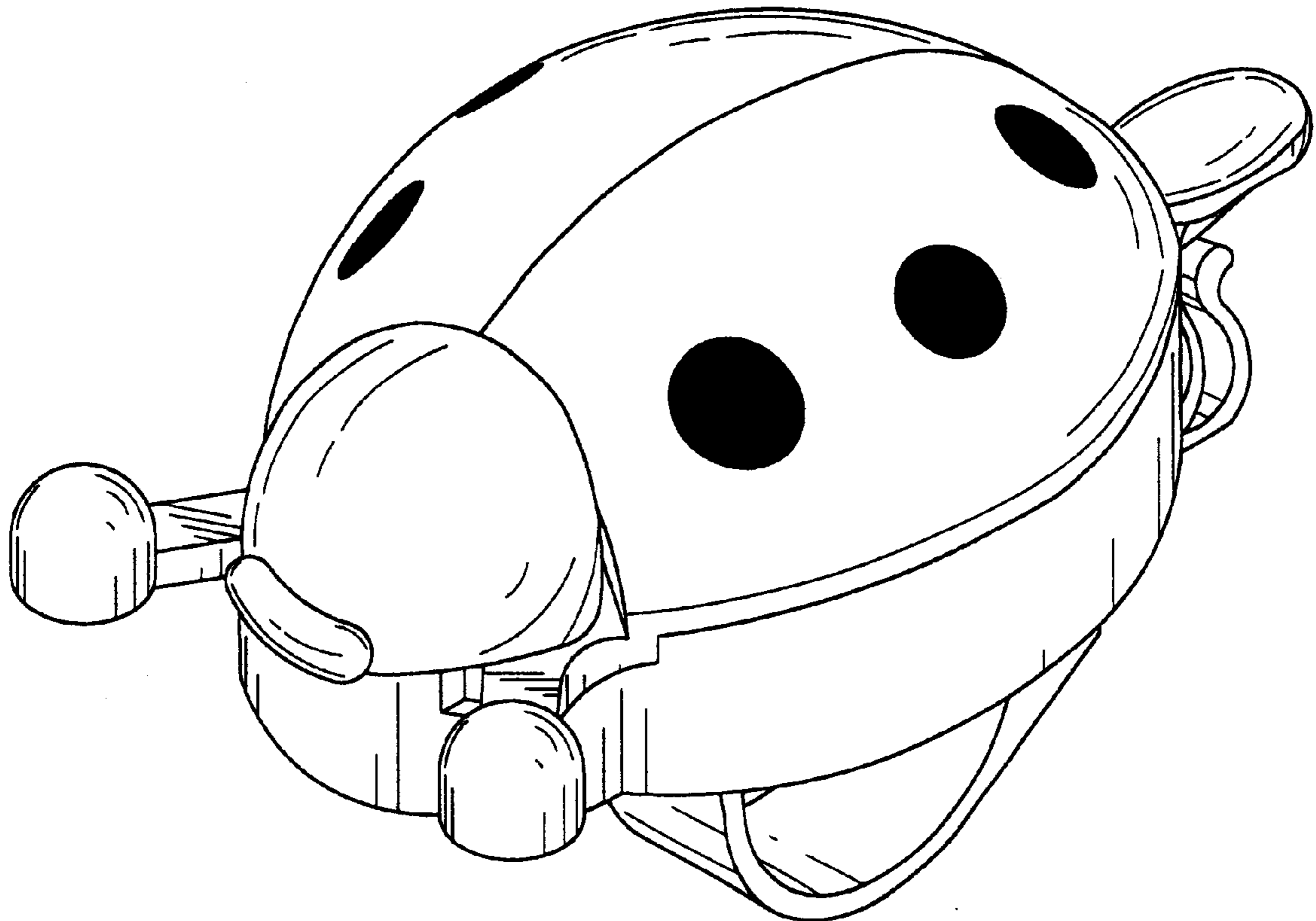

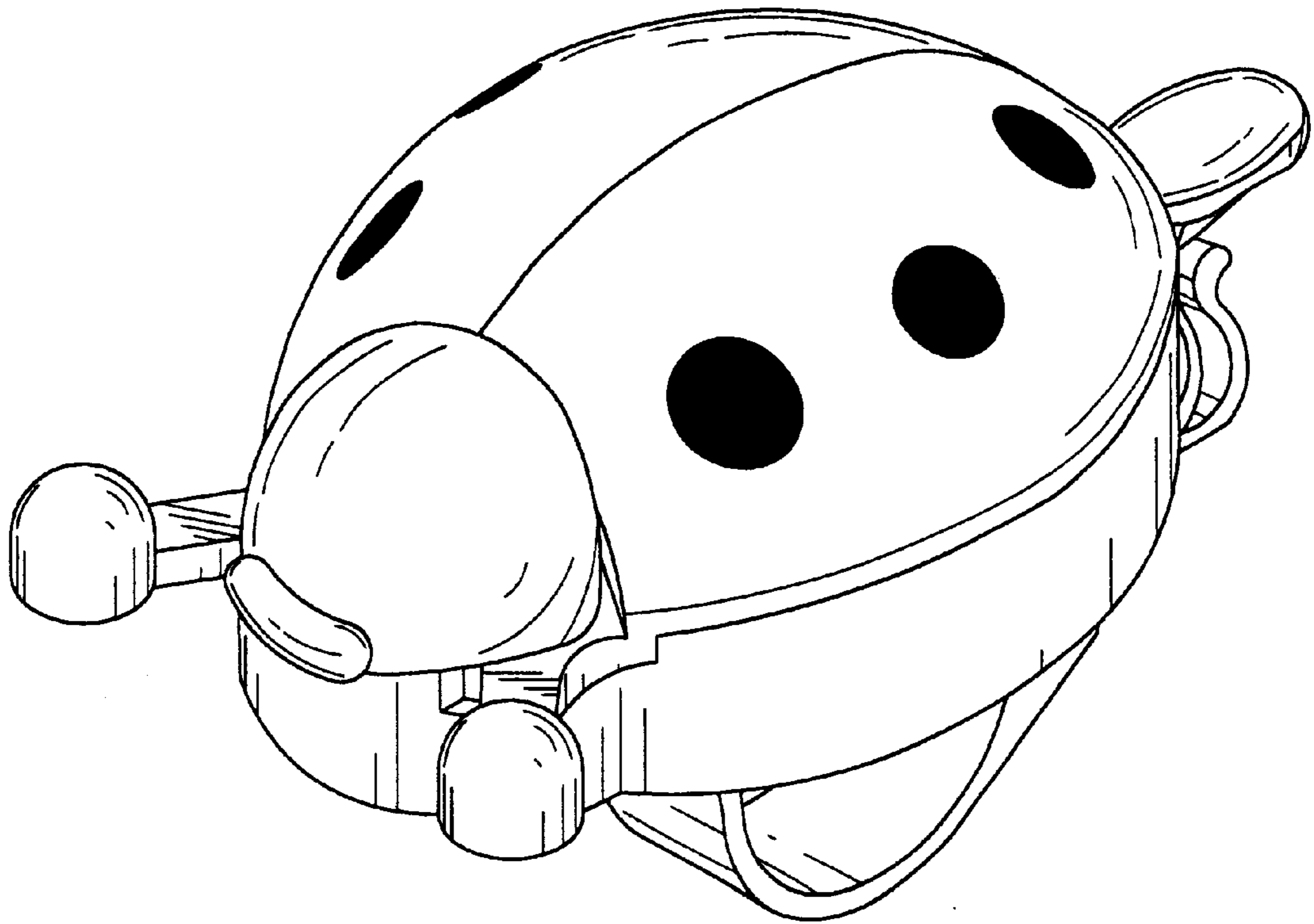

FIG. 1

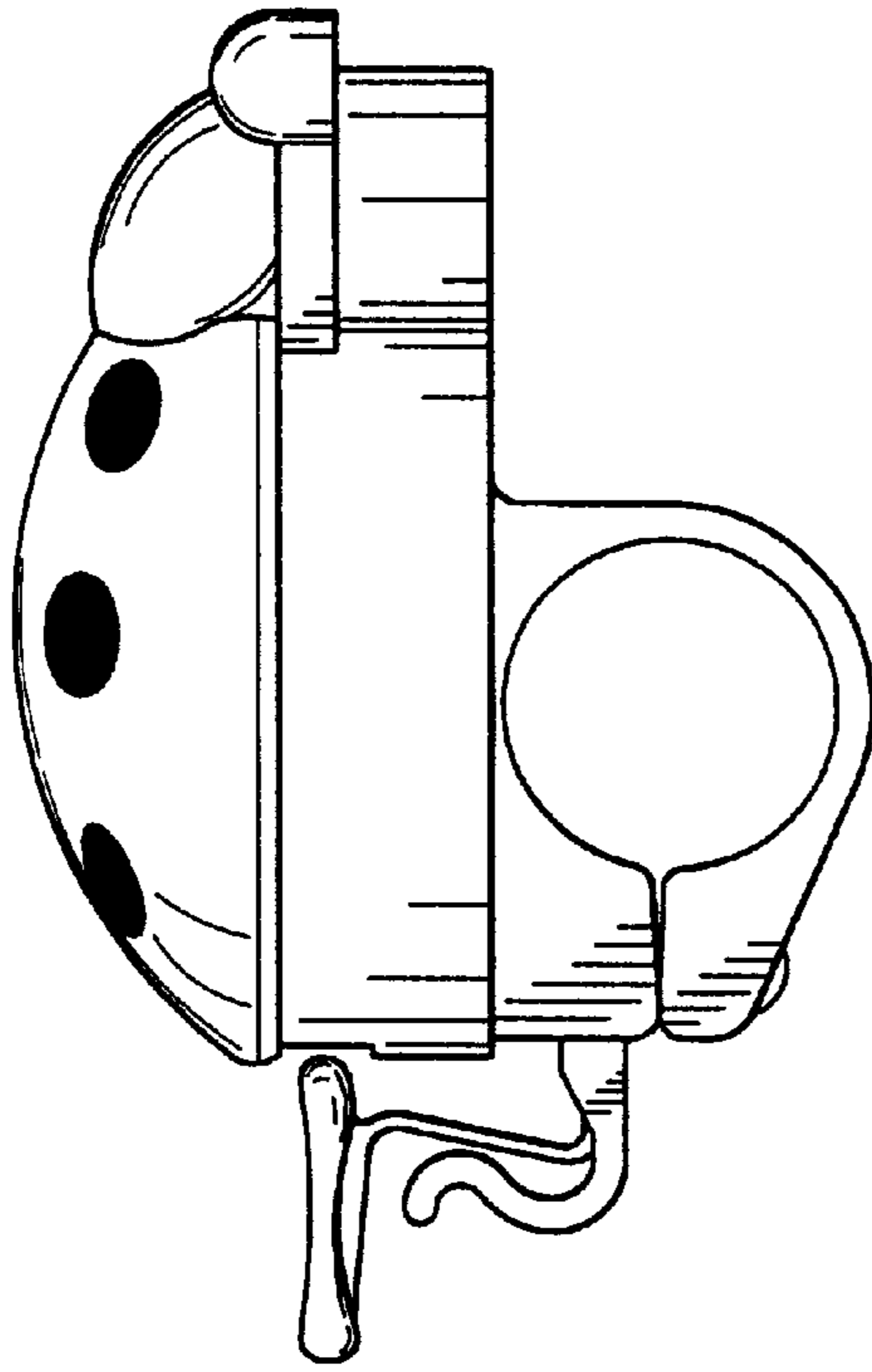

FIG. 3

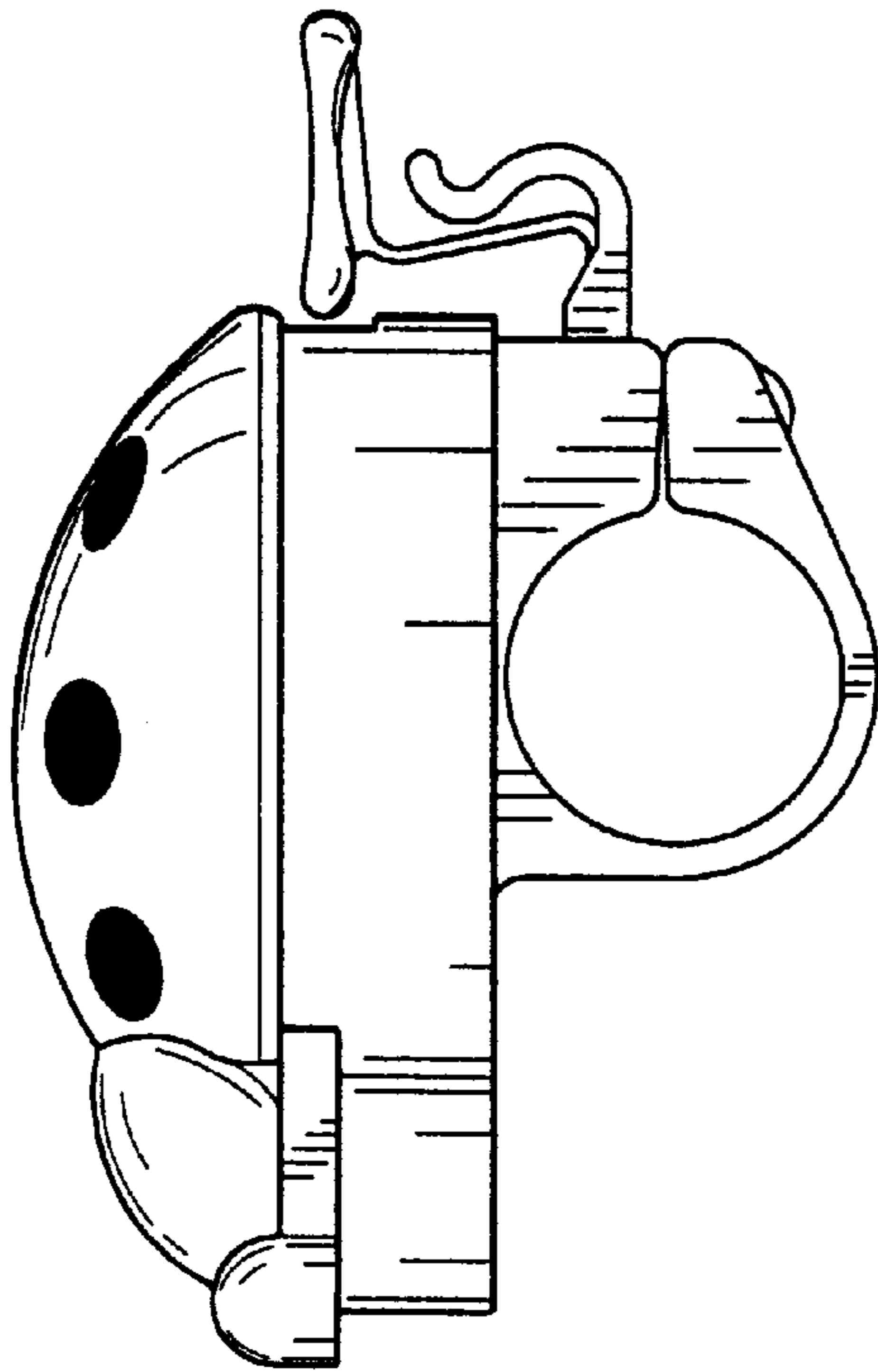

FIG. 2

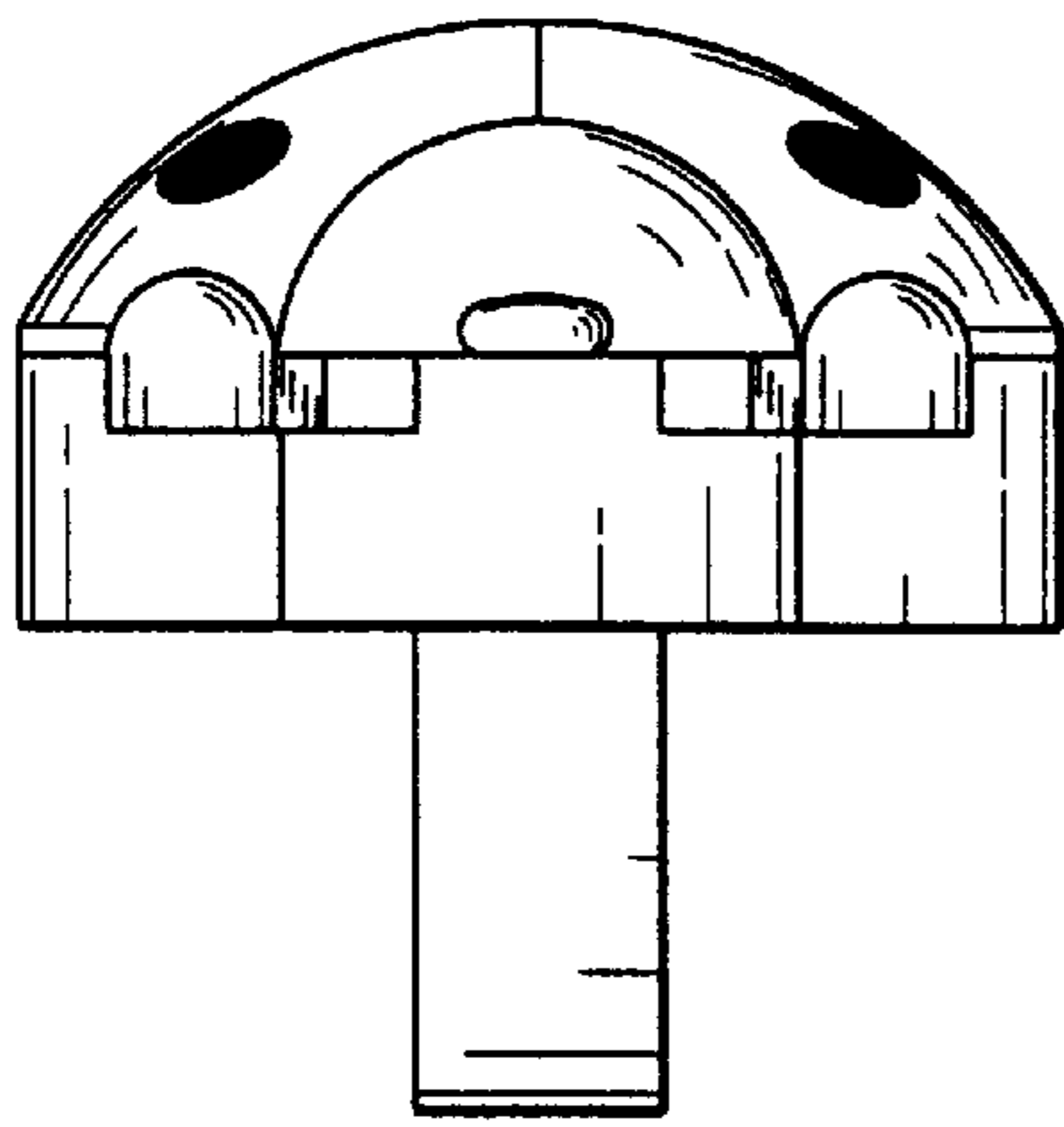

FIG. 4

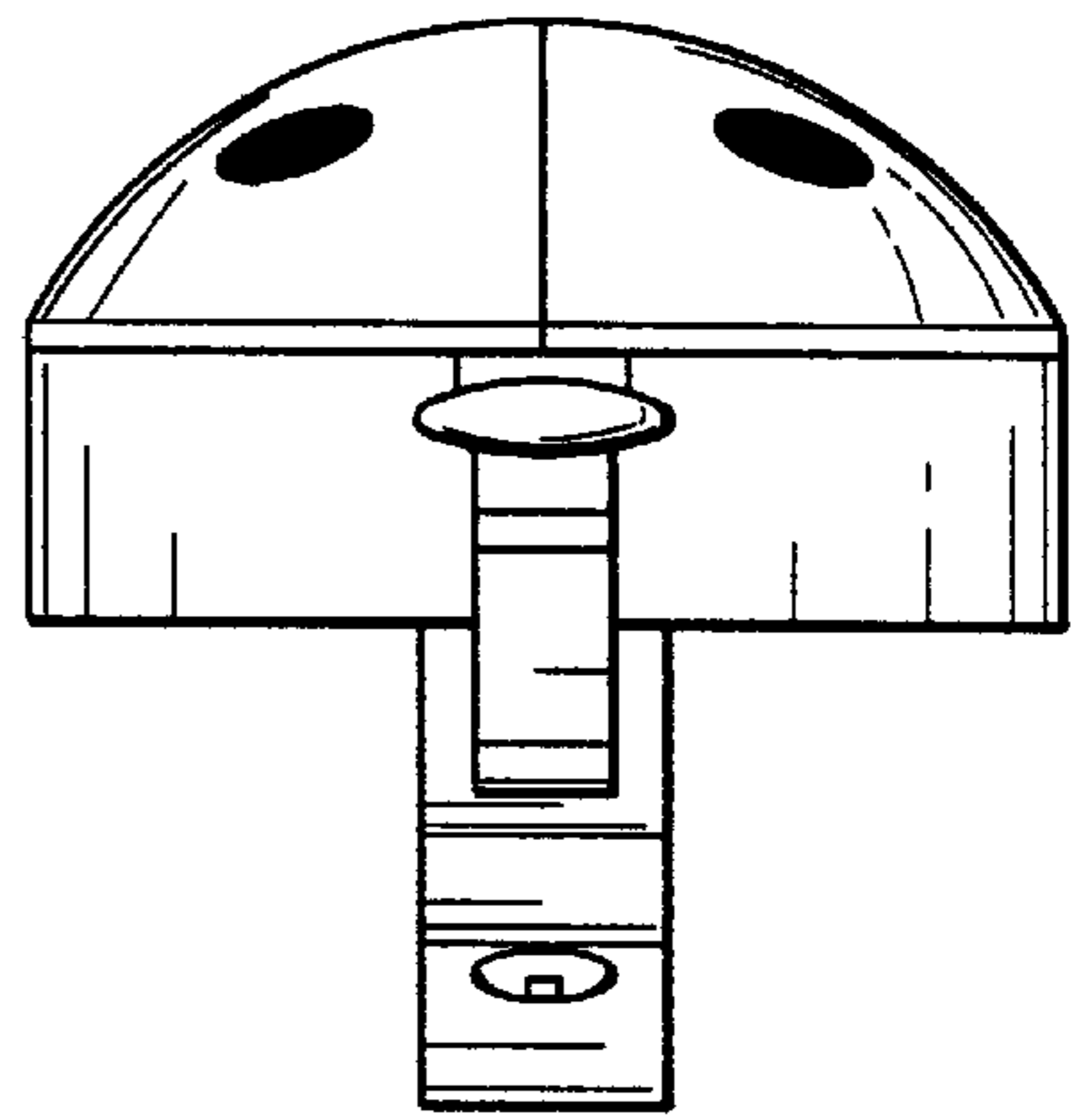

FIG. 5

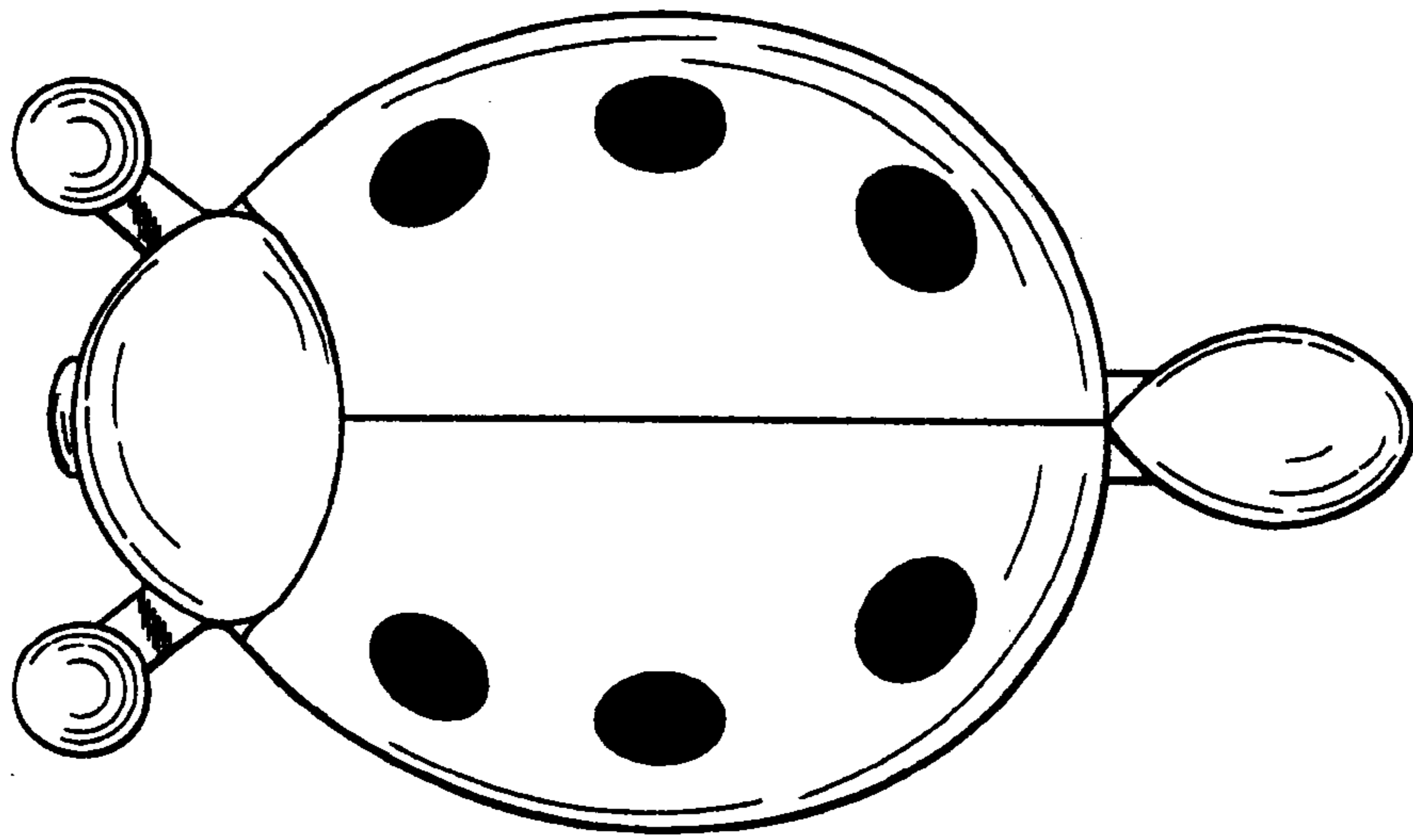

FIG. 6

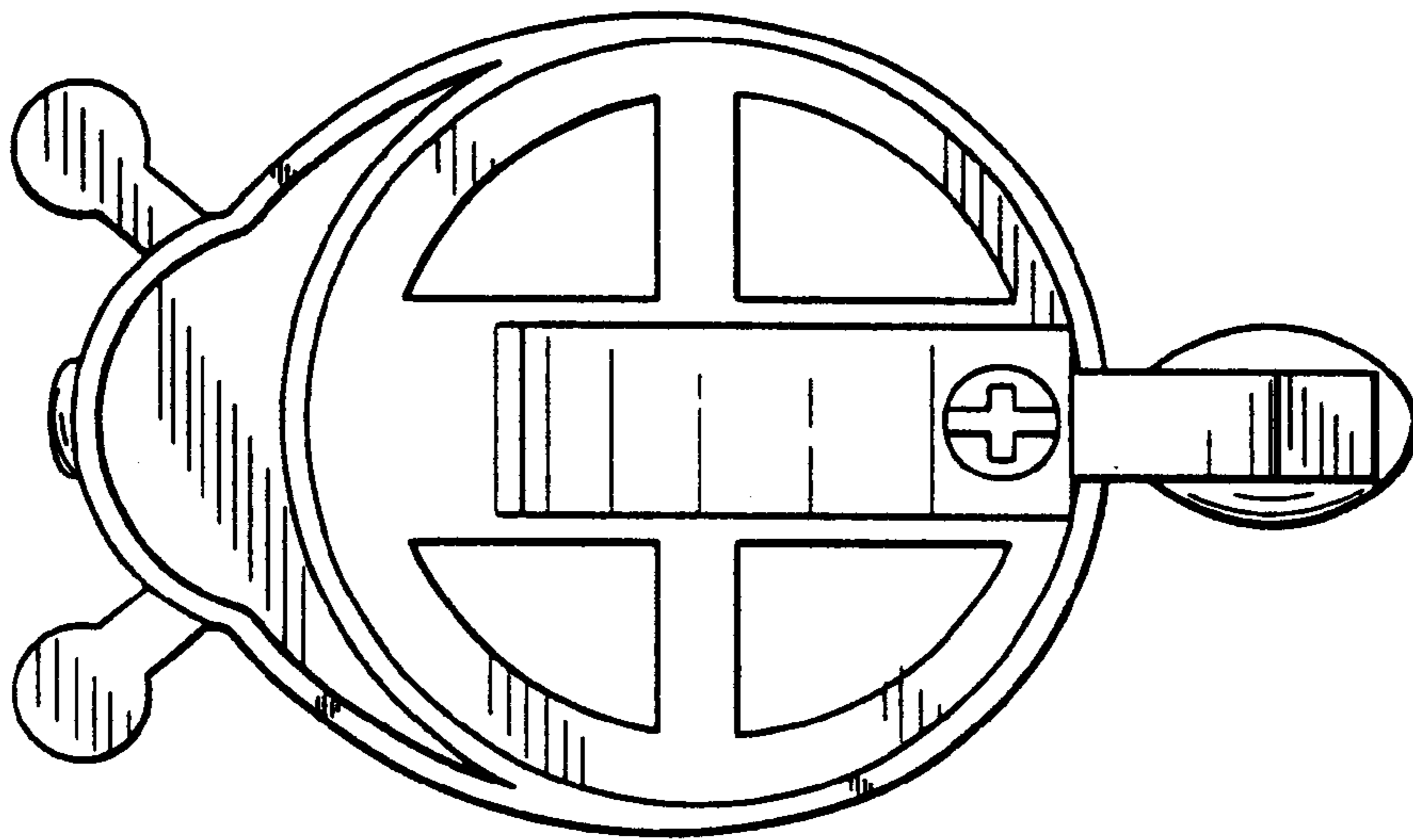

FIG. 7