



US00D444704S

(12) **United States Design Patent**  
**Smouha**

(10) **Patent No.:** **US D444,704 S**

(45) **Date of Patent:** **\*\* Jul. 10, 2001**

(54) **DUAL PURPOSE DISPLAY CASE FOR WRIST WATCH AND OTHER JEWELRY**

3,918,577 \* 11/1975 Horzick ..... 206/301 X  
5,285,897 \* 2/1994 Ozaki ..... 206/1.5  
5,383,552 \* 1/1995 Dikowitz ..... 206/6.1

(75) Inventor: **Joseph Smouha**, New York, NY (US)

\* cited by examiner

(73) Assignee: **A Classic Time Watch Co., Inc.**, New York, NY (US)

*Primary Examiner*—Prabhakar Deshmukh  
(74) *Attorney, Agent, or Firm*—Malina & Wolson; Bernard Malina

(\*\*) Term: **14 Years**

(21) Appl. No.: **29/126,085**

(22) Filed: **Jul. 7, 2000**

(51) **LOC (7) Cl.** ..... **09-03**

(52) **U.S. Cl.** ..... **D9/423**

(58) **Field of Search** ..... D9/414, 415, 418, D9/430, 432, 337, 422, 423, 424; 206/6.1, 18, 301, 508, 566, 775, 776, 594; D28/83

(56) **References Cited**

**U.S. PATENT DOCUMENTS**

- D. 311,684 \* 10/1990 Newell et al. .... D9/418
- D. 355,359 \* 2/1995 Herzog ..... D9/422
- D. 373,725 \* 9/1996 Well ..... D9/422
- D. 387,982 \* 12/1997 Kaplan ..... D9/423
- 1,816,101 \* 7/1931 Verger ..... 206/301 X

(57) **CLAIM**

The ornamental design for dual purpose display case for wrist watch and other jewelry, as shown and described.

**DESCRIPTION**

FIG. 1 is a top perspective view of the dual purpose display case for wrist watch and other jewelry, showing a new design;  
FIG. 2 is a rear elevational view thereof;  
FIG. 3 is a side view thereof;  
FIG. 4 is a top plan view thereof;  
FIG. 5 is a front elevational view thereof; and,  
FIG. 6 is a top perspective view thereof showing the dual purpose display case for wrist watch and other jewelry in the open condition with the contents disassembled.

**1 Claim, 3 Drawing Sheets**

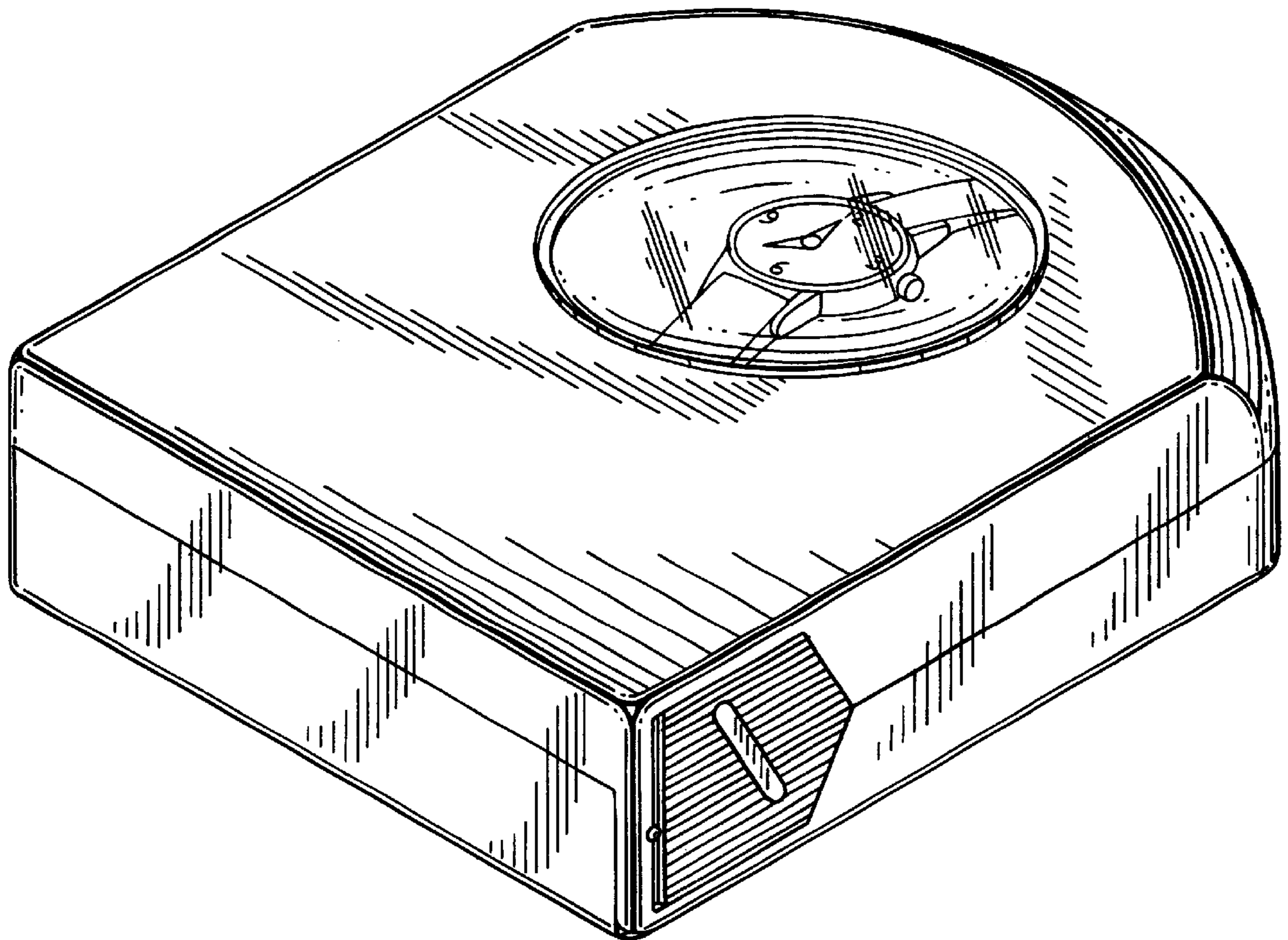

*FIG. 1*

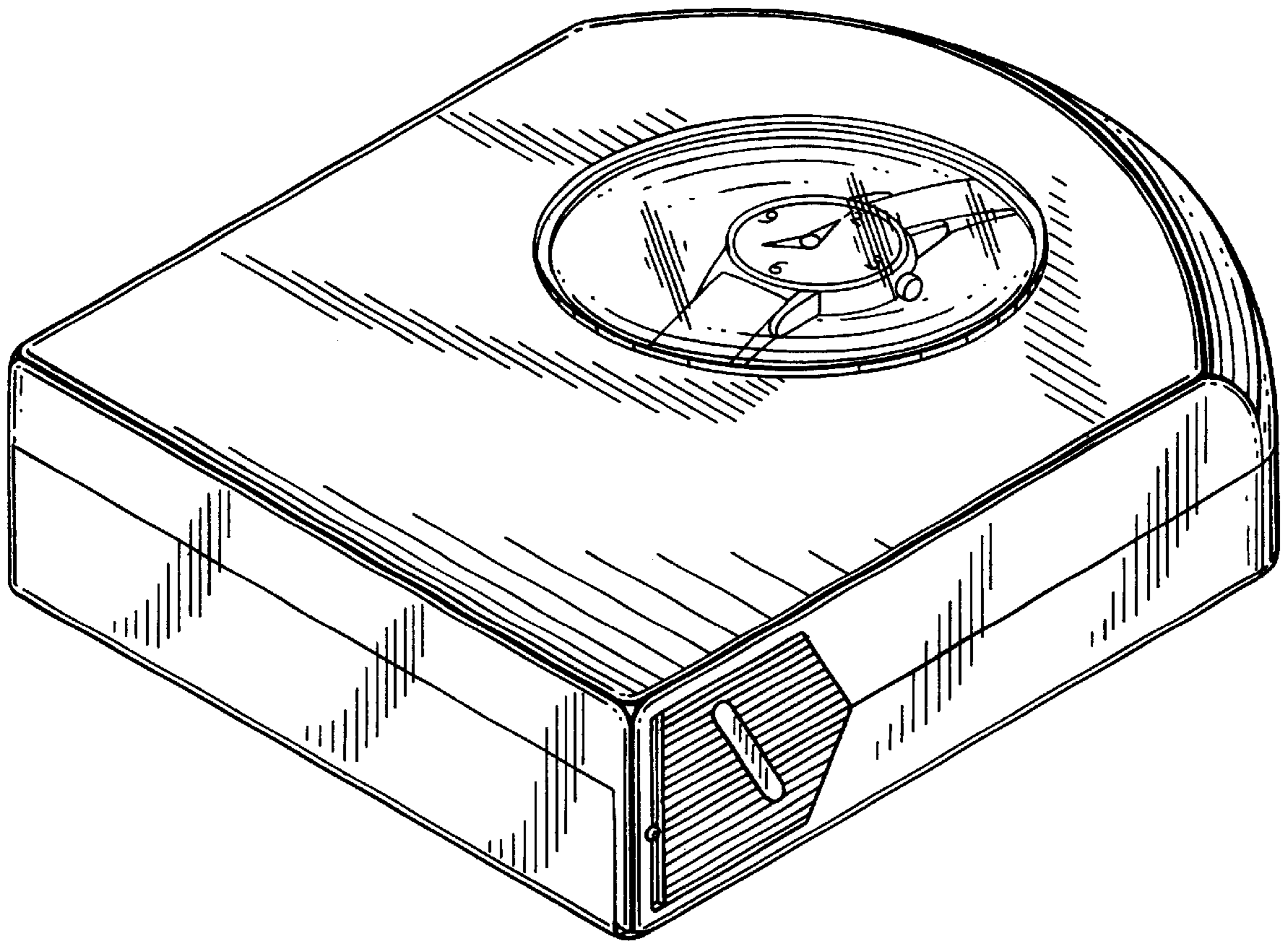

*FIG. 2*

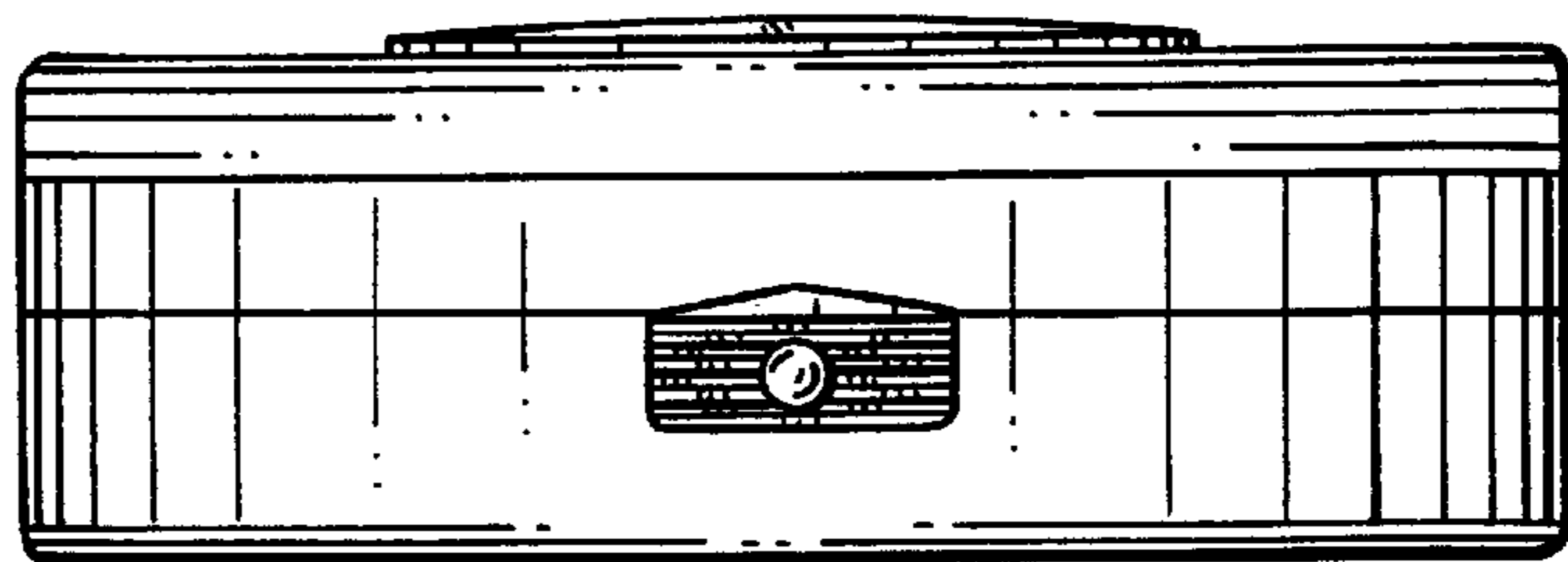

*FIG. 3*

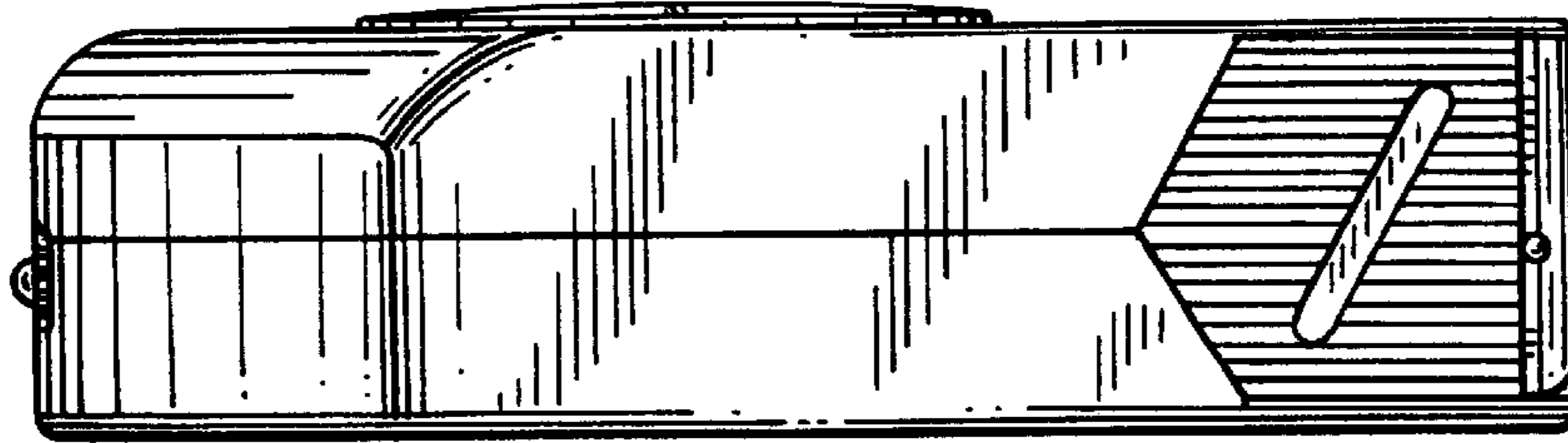

*FIG. 4*

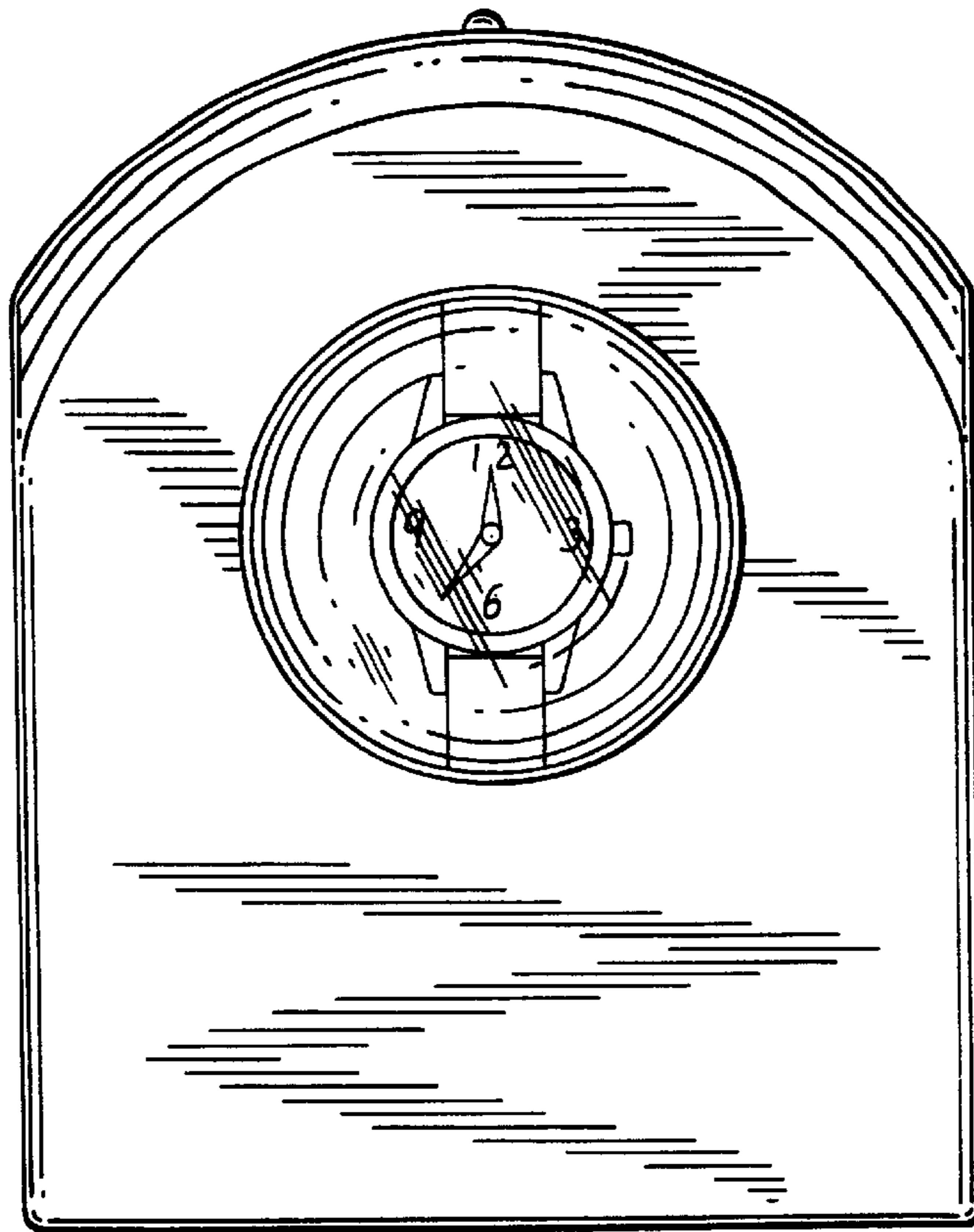

*FIG. 5*

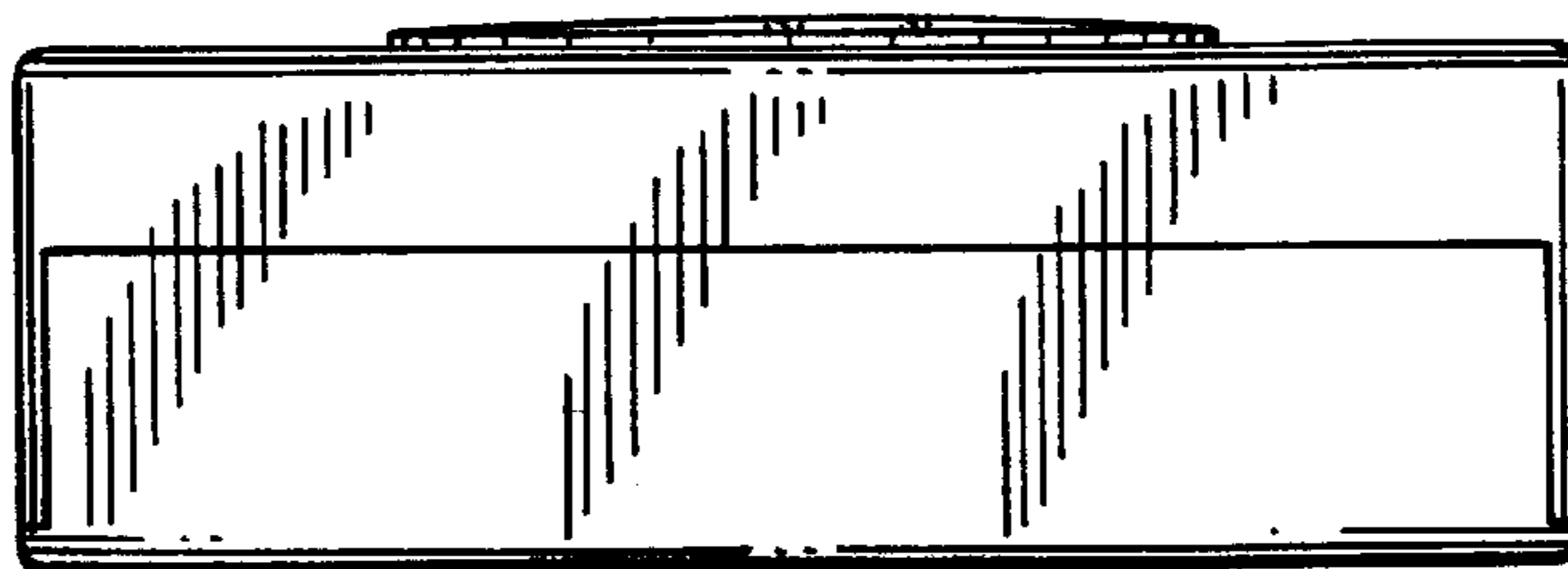



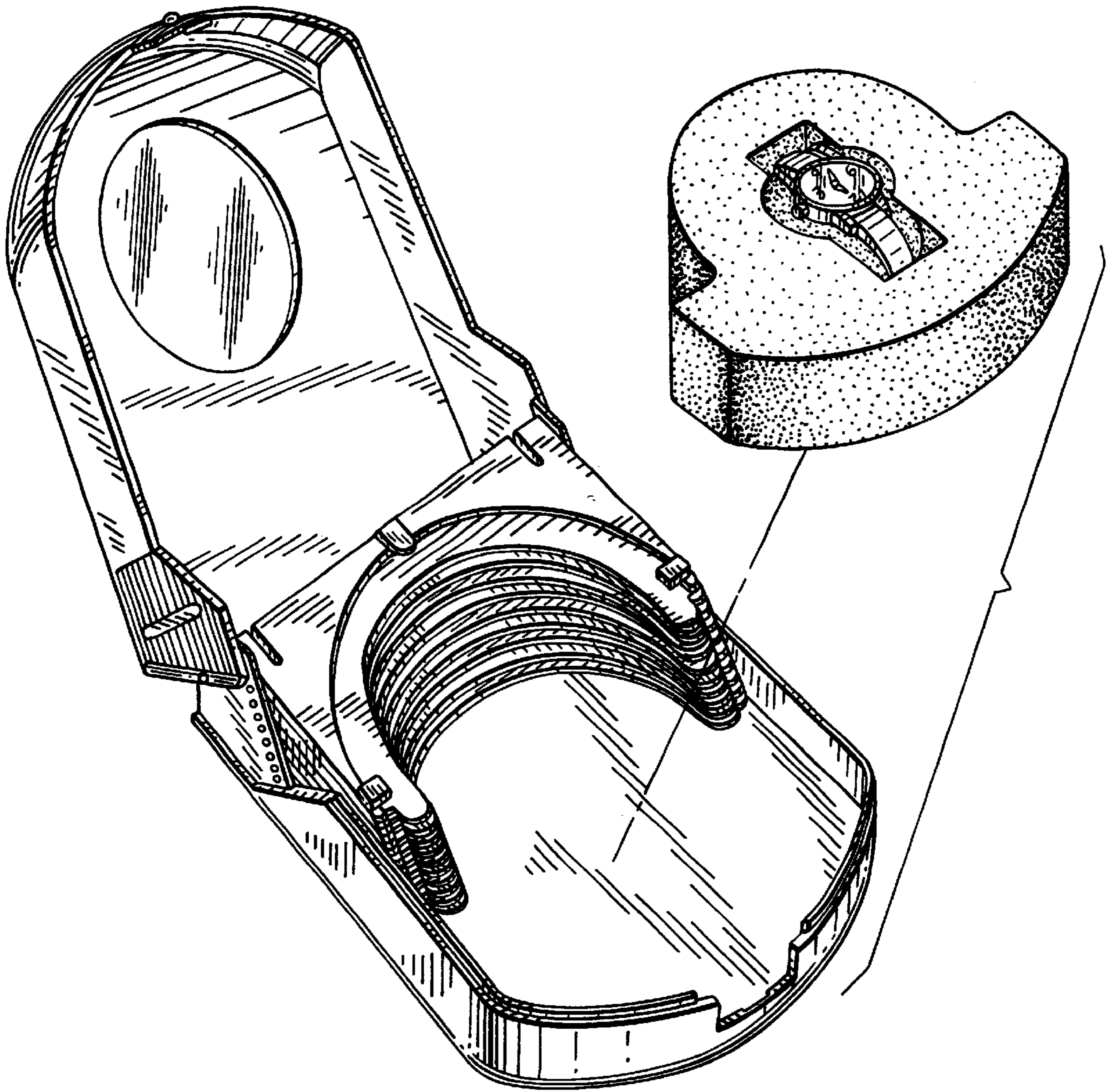

**FIG. 6**