



US00D444478S

(12) **United States Design Patent**
Shimizu

(10) **Patent No.:** **US D444,478 S**

(45) **Date of Patent:** **** Jul. 3, 2001**

(54) **INTERNAL COMBUSTION ENGINE**

D. 421,024 * 2/2000 Katoh D15/1

(75) Inventor: **Hirohide Shimizu**, Tsurugashima (JP)

FOREIGN PATENT DOCUMENTS

(73) Assignee: **Honda Giken Kogyo Kabushiki Kaisha**, Tokyo (JP)

1050001 9/1999 (JP) .

(**) Term: **14 Years**

* cited by examiner

(21) Appl. No.: **29/125,644**

Primary Examiner—Melody N. Brown

(22) Filed: **Jun. 26, 2000**

(74) *Attorney, Agent, or Firm*—Blank Rome Comisky & McCauley LLP

(30) **Foreign Application Priority Data**

(57) **CLAIM**

Dec. 28, 1999 (JP) 11-36728

The ornamental design for an internal combustion engine, as shown and described.

(51) **LOC (7) Cl.** **15-01**

DESCRIPTION

(52) **U.S. Cl.** **D15/1**

FIG. 1 is a front perspective view of an internal combustion engine showing my design;

(58) **Field of Search** D15/1, 2; 123/156 BA, 123/50 A, 56, 306, 41.7, 308, 198 E, 661, 667; D34/15; 46/78, 39, 249

FIG. 2 is a perspective view of the rear thereof;

FIG. 3 is a front view thereof;

FIG. 4 is a rear view thereof;

FIG. 5 is a top plan view thereof;

FIG. 6 is a bottom plan view thereof;

FIG. 7 is a side view thereof; and,

FIG. 8 is an opposite side view thereof.

(56) **References Cited**

U.S. PATENT DOCUMENTS

D. 310,373 * 9/1990 Ishii et al. D15/1

D. 396,476 * 7/1998 Shimizu D15/1

D. 414,498 * 9/1999 Yoshida D15/1

1 Claim, 4 Drawing Sheets

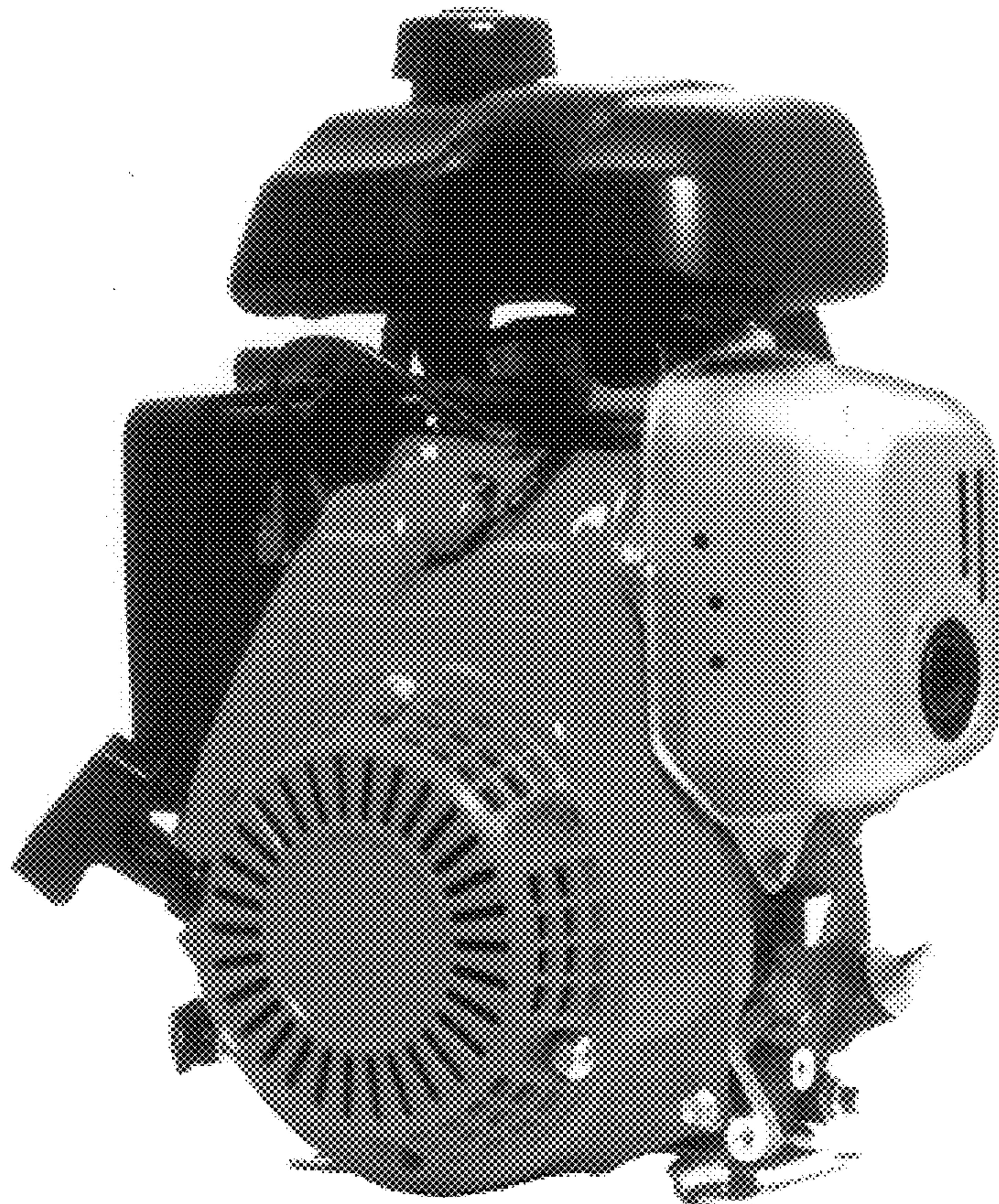

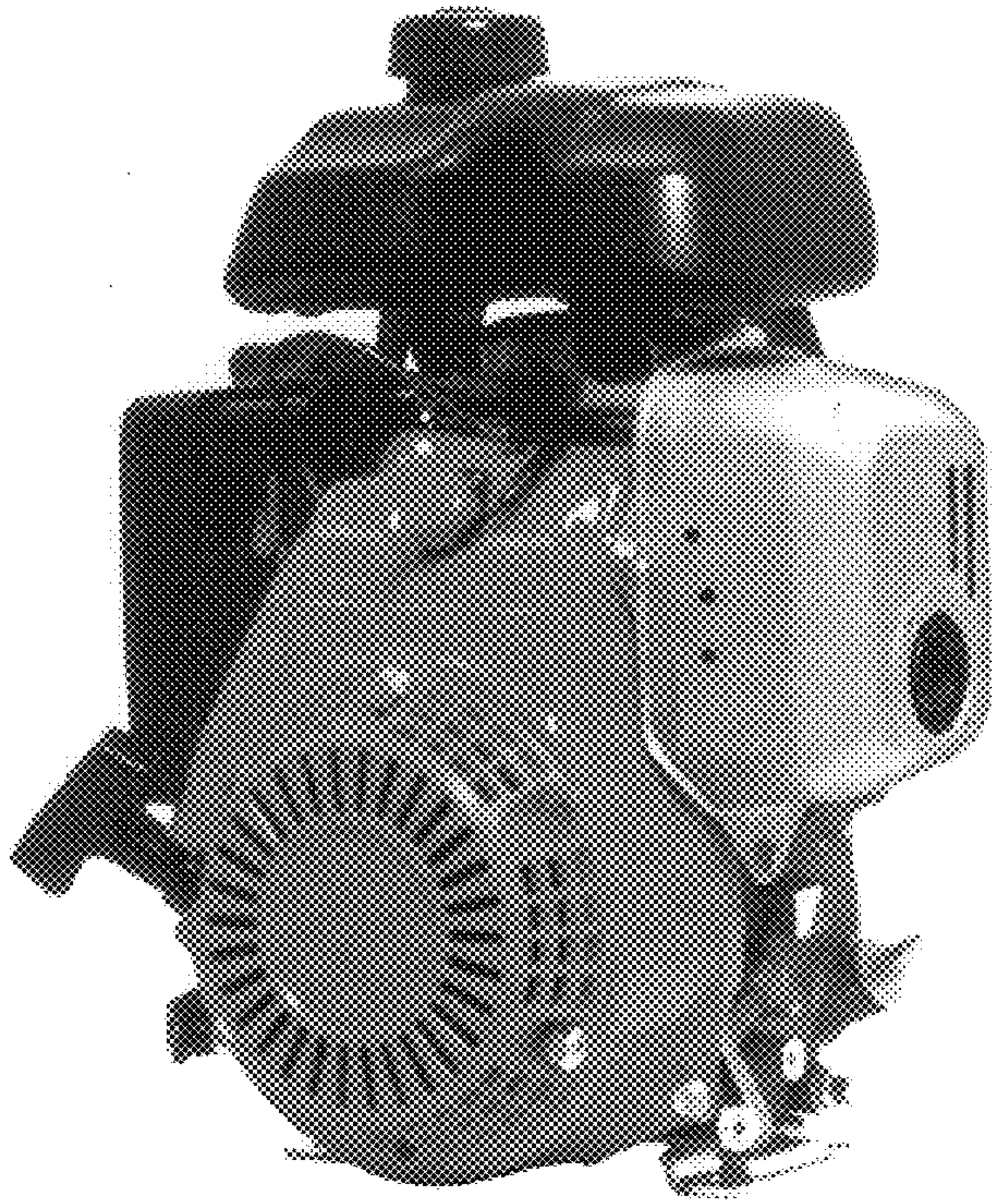
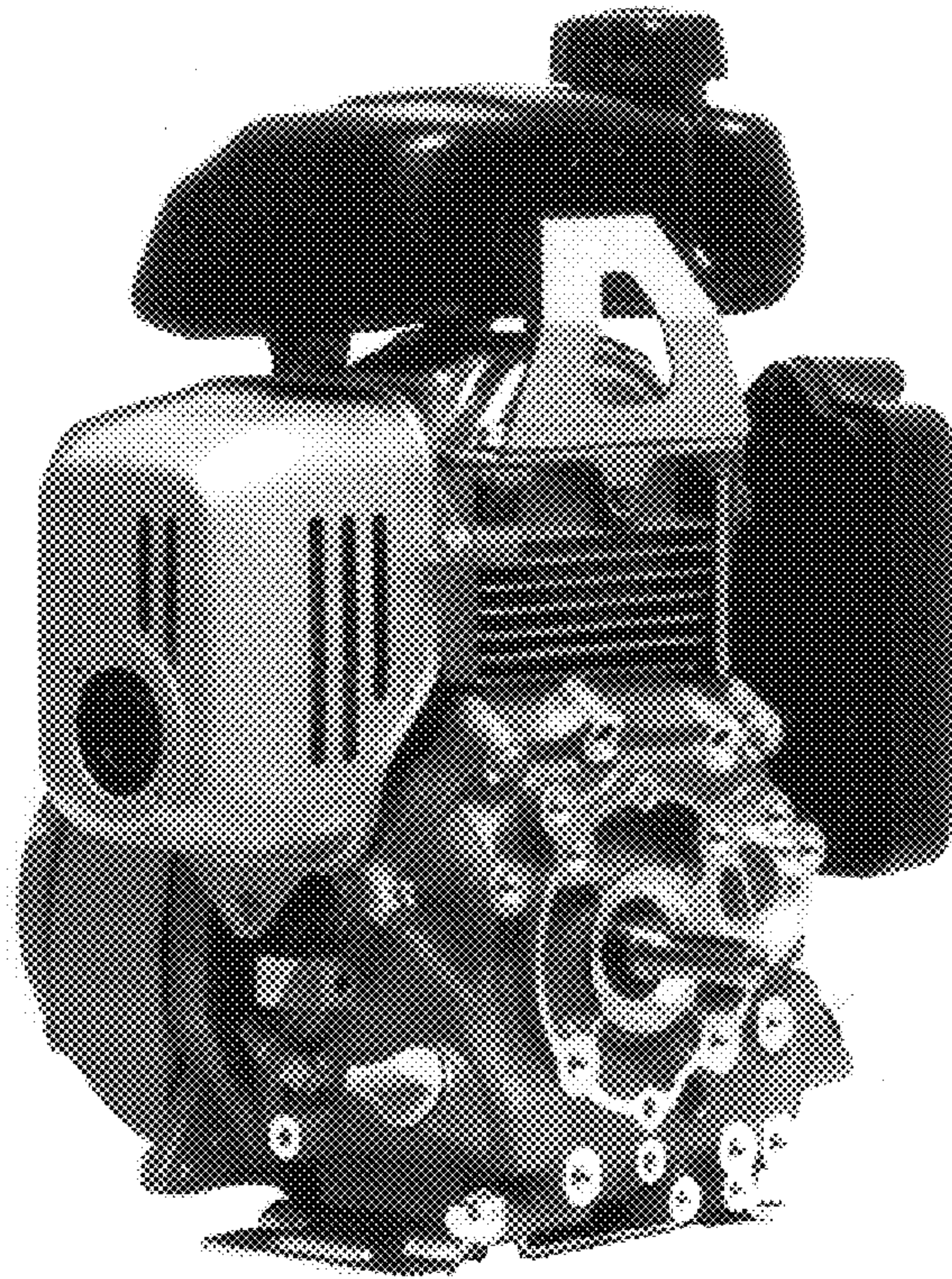

FIG. 1

FIG. 2



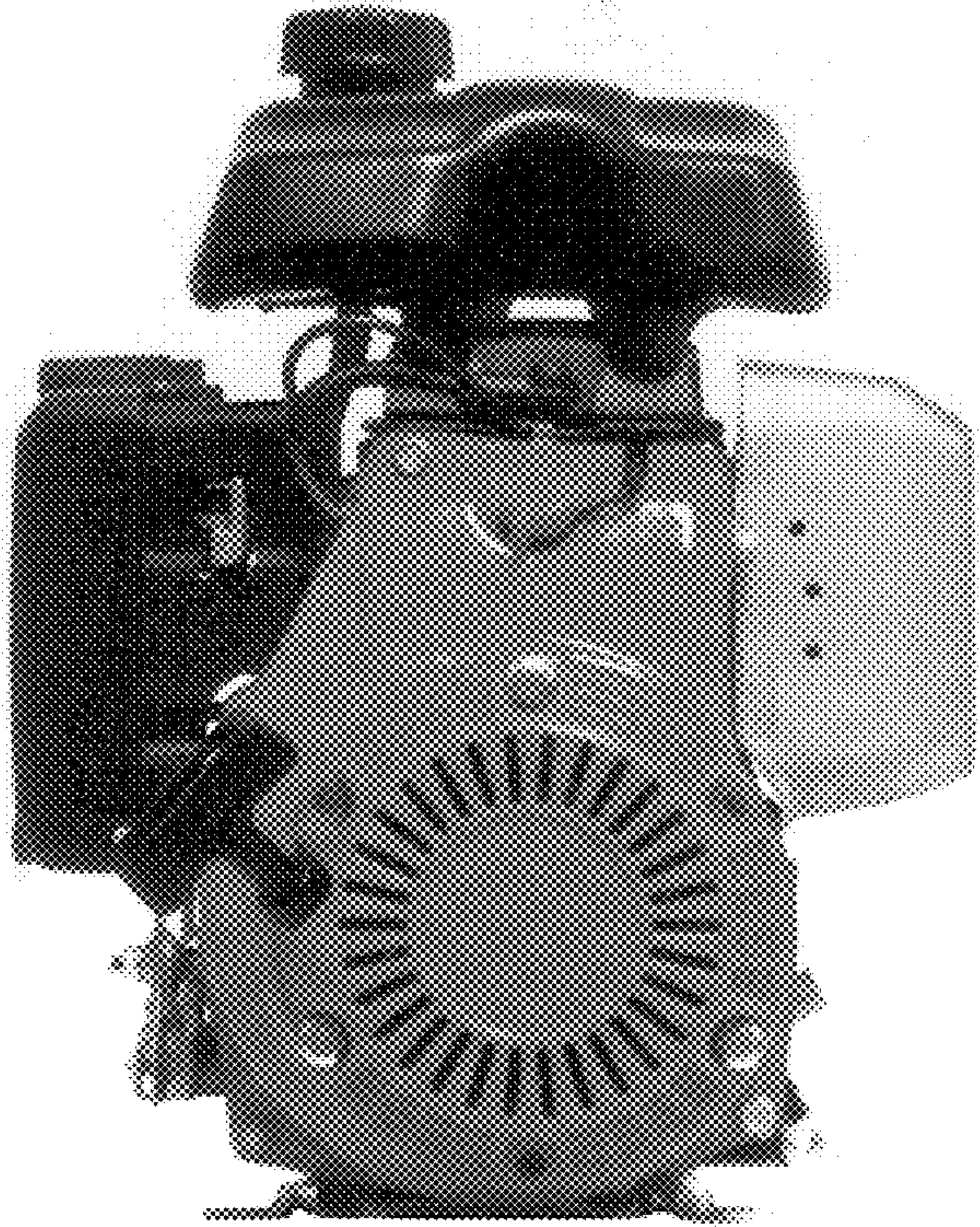
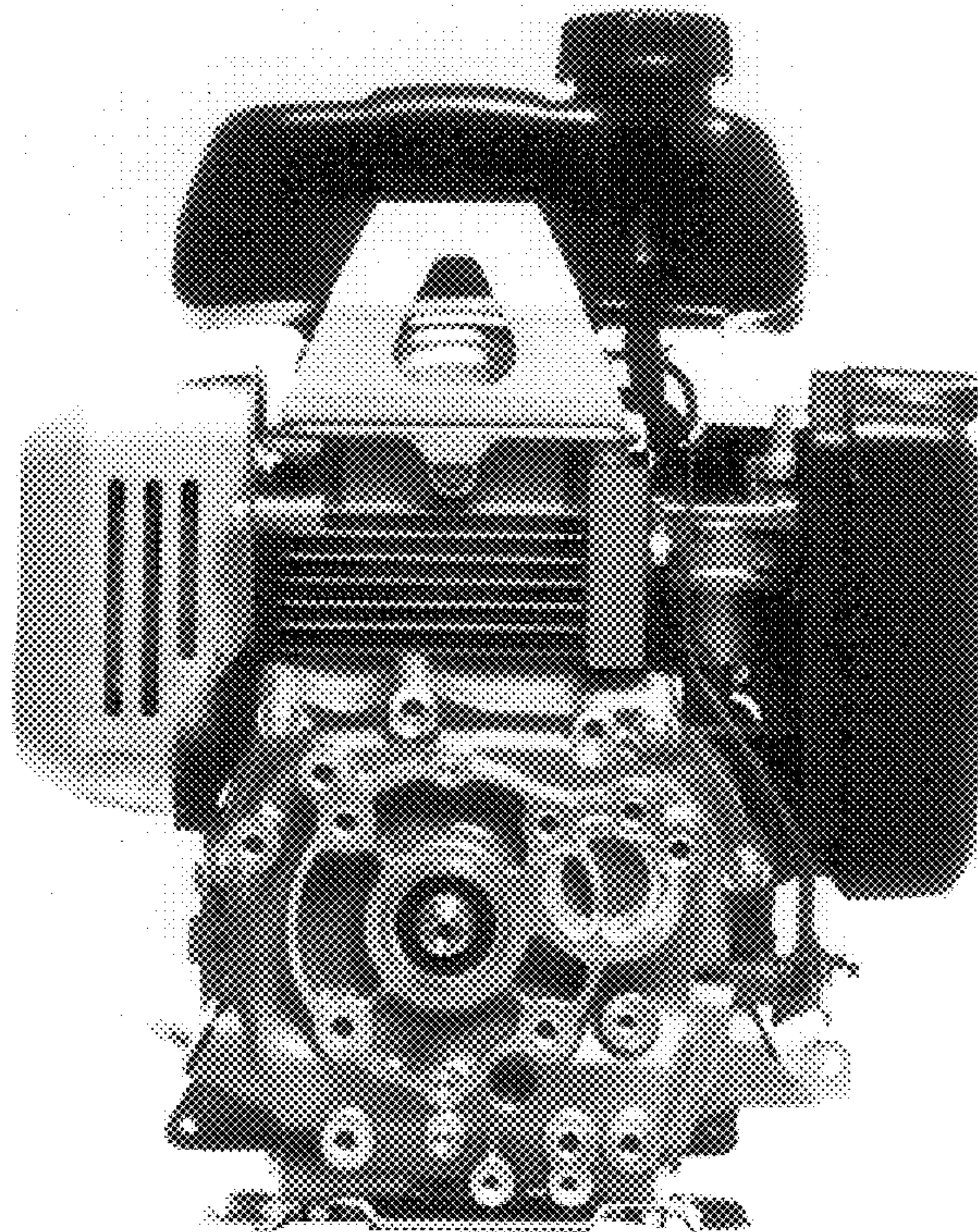

FIG. 3

FIG. 4



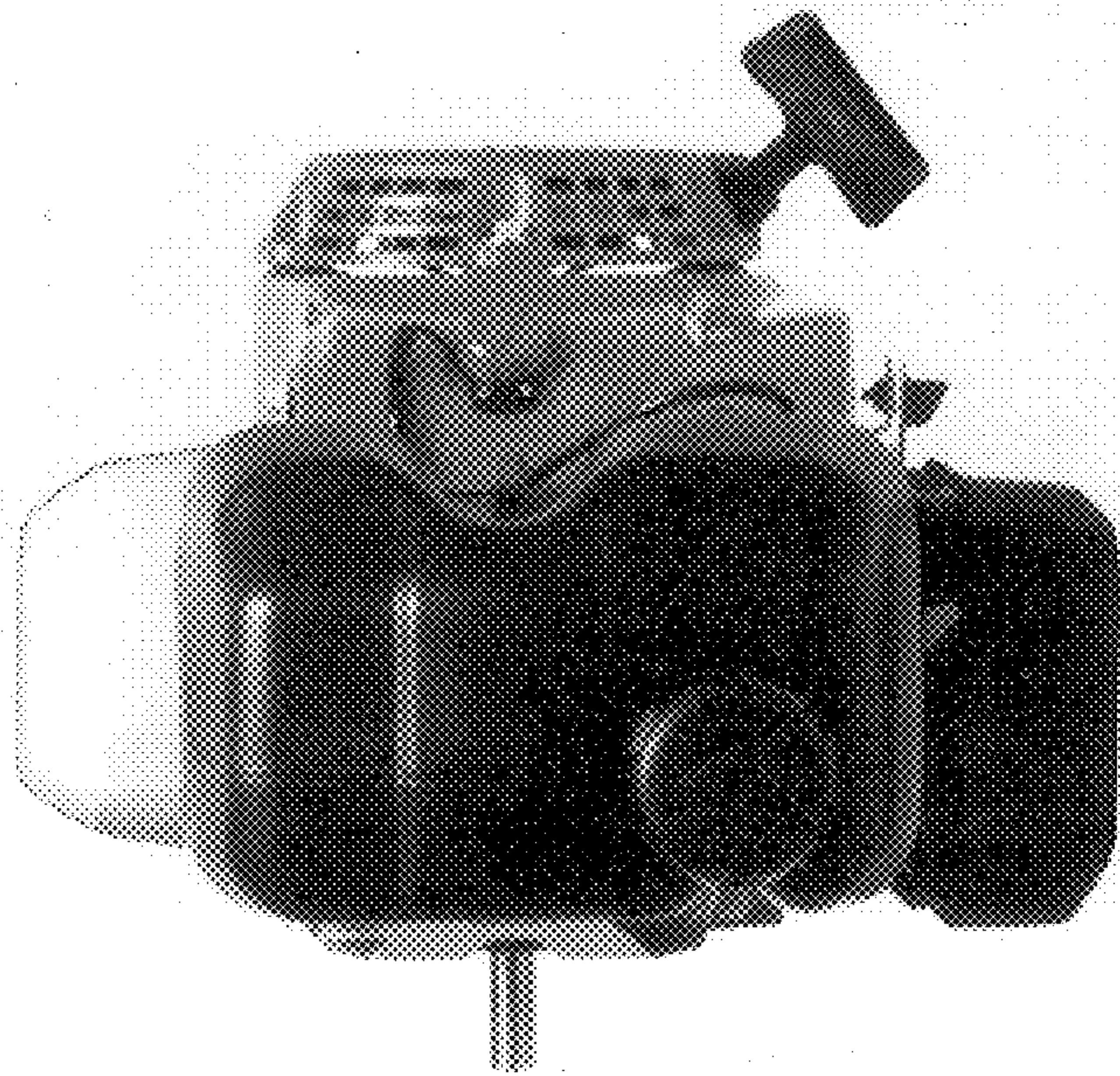
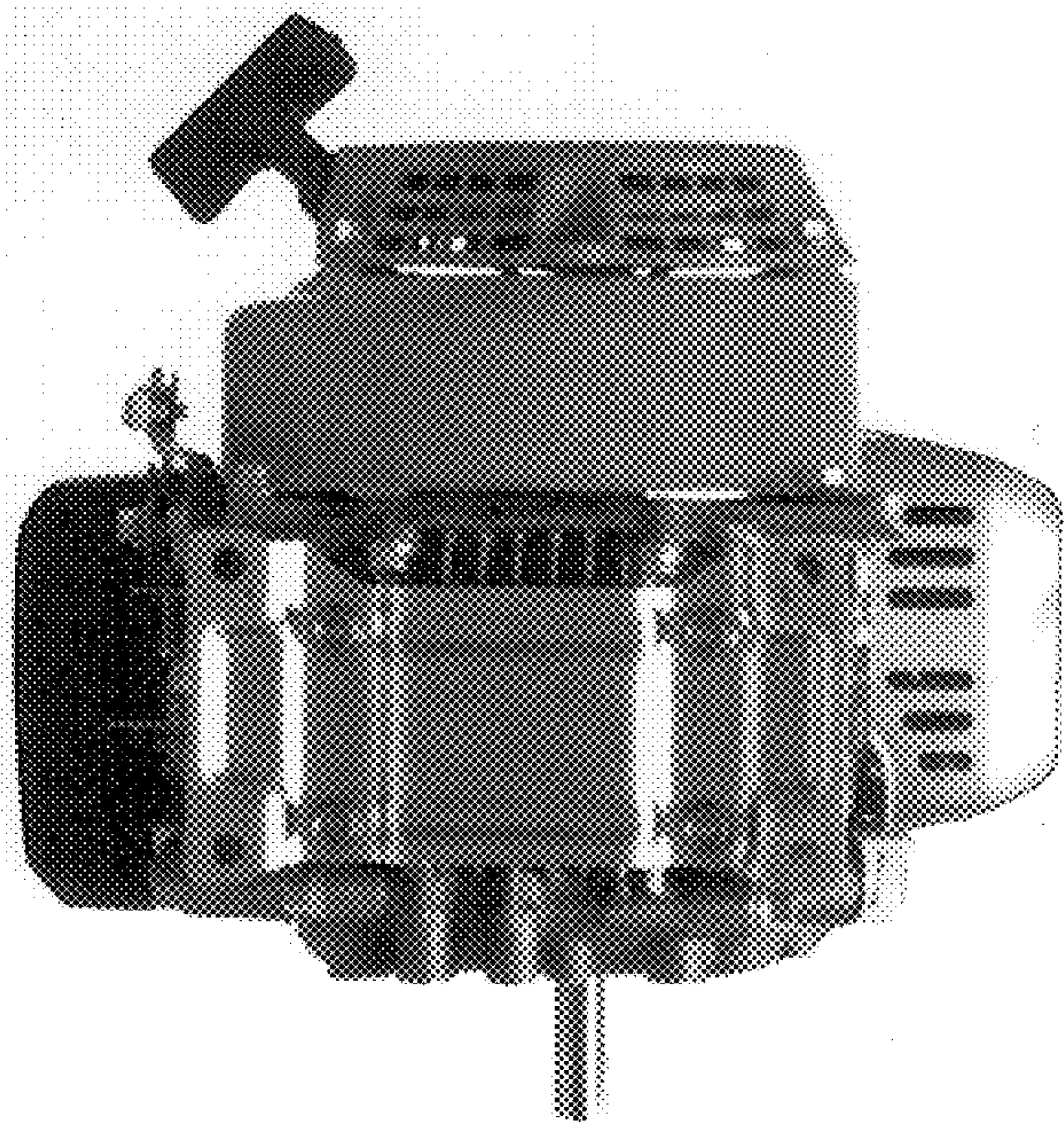

FIG. 5

FIG. 6



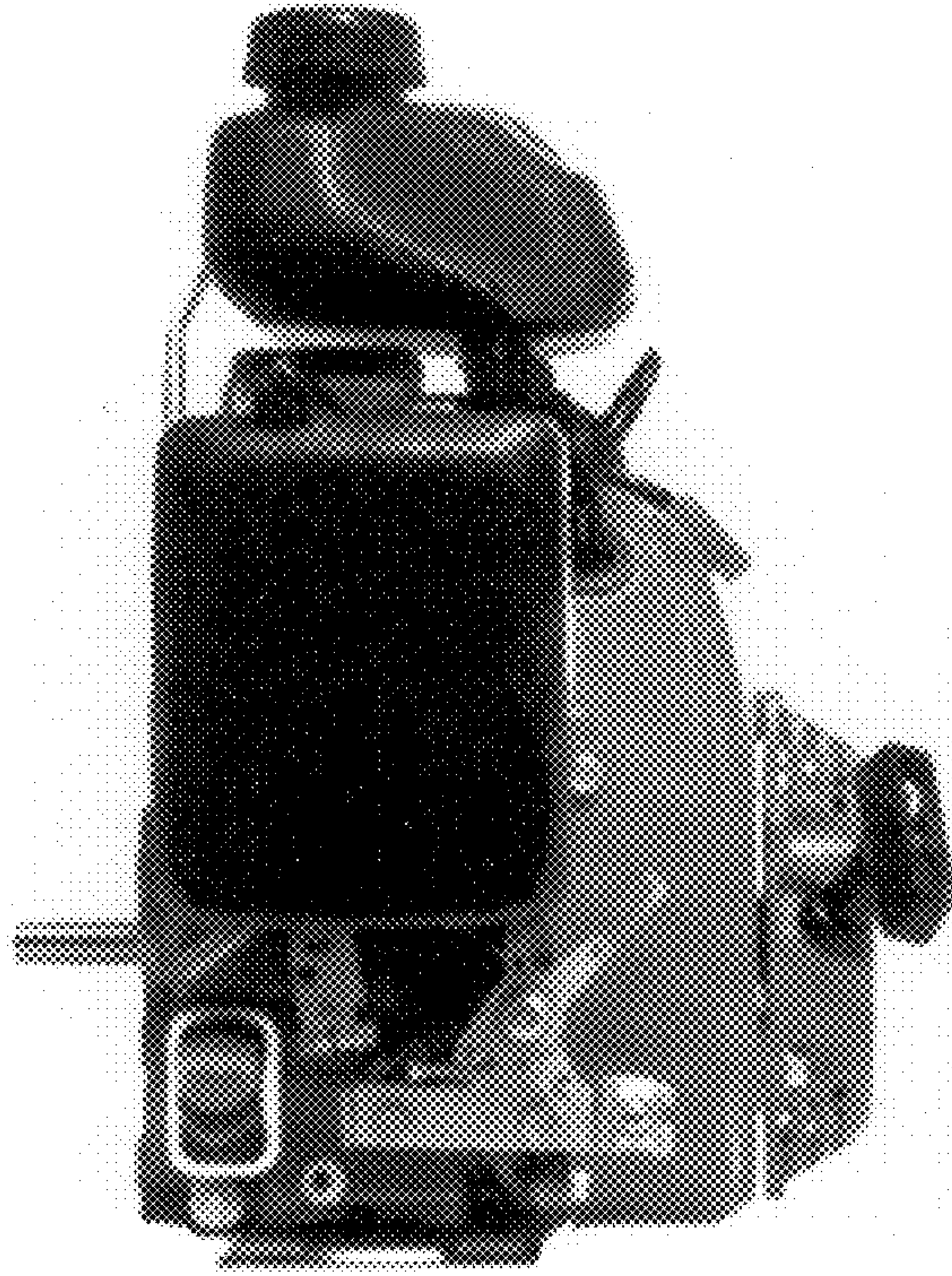

FIG. 7

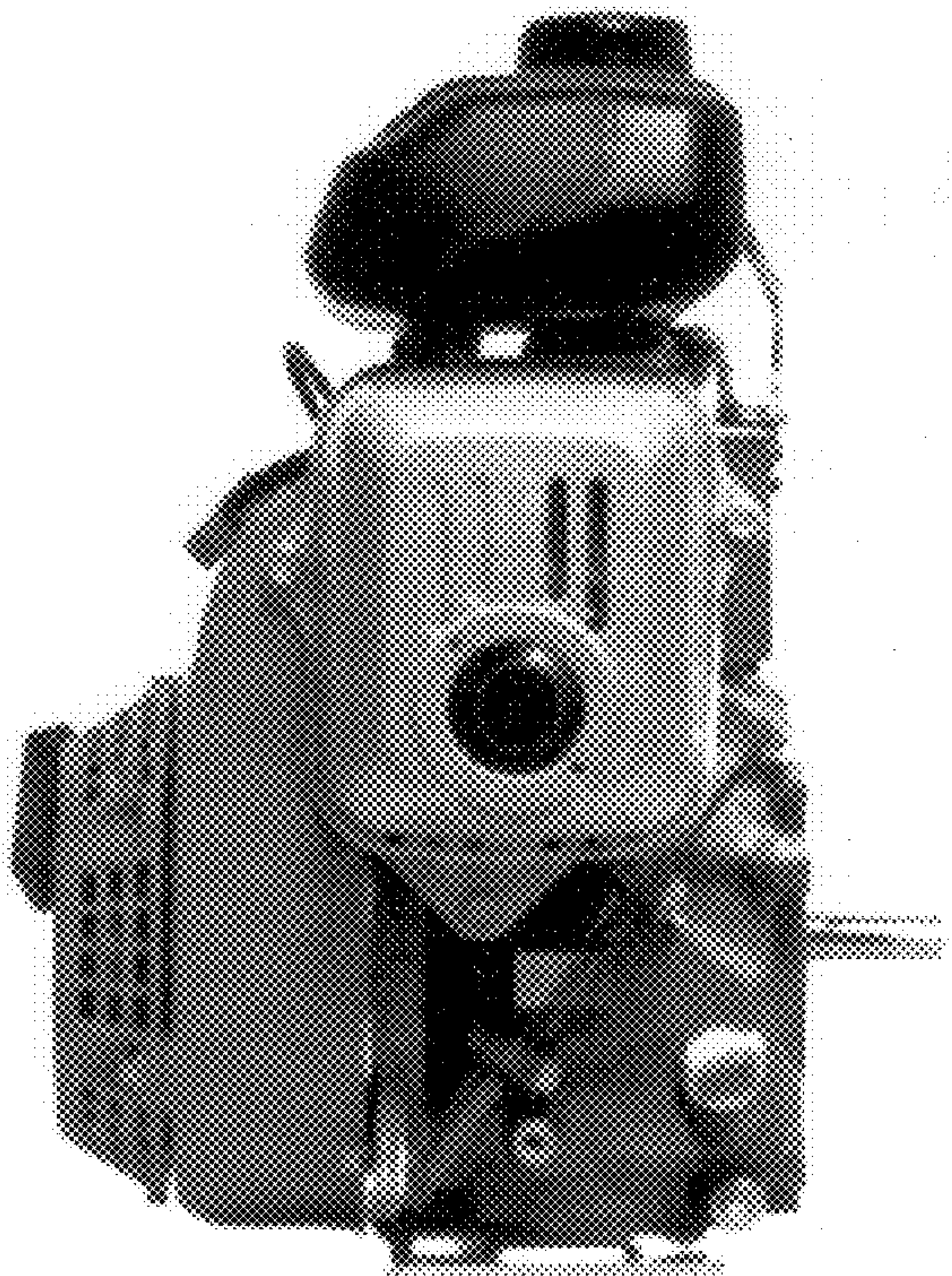

FIG. 8