



US00D444460S

(12) **United States Design Patent**
Kitazawa et al.

(10) **Patent No.:** **US D444,460 S**

(45) **Date of Patent:** **** Jul. 3, 2001**

(54) **CONTROLLER FOR ELECTRONIC
PERCUSSION INSTRUMENT**

(75) Inventors: **Atsushi Kitazawa; Ikuro Mine**, both
of Shizuoka-ken (JP)

(73) Assignee: **Yamaha Corporation**, Shizuoka-ken
(JP)

(**) Term: **14 Years**

(21) Appl. No.: **29/130,543**

(22) Filed: **Oct. 3, 2000**

(30) **Foreign Application Priority Data**

Apr. 11, 2000 (JP) 12-009414

(51) **LOC (7) Cl.** **14-01**

(52) **U.S. Cl.** **D14/217; D17/99**

(58) **Field of Search** D14/217, 162,
D14/299; D17/22, 99; 84/600, 622, 711,
723, DIG. 12; 381/28, 119

(56) **References Cited**

U.S. PATENT DOCUMENTS

D. 325,910 * 5/1992 Ito et al. D14/162

D. 384,356 * 9/1997 Ito et al. D14/217

D. 387,798 * 12/1997 Miura D17/99

D. 402,984 * 12/1998 Ito et al. D14/162

D. 435,250 * 12/2000 Mackie et al. D14/217

4,314,496 * 2/1982 Tavel 84/711

* cited by examiner

Primary Examiner—Adir Aronovich

(74) *Attorney, Agent, or Firm*—Weingarten, Schurgin,
Gagnebin & Hayes LLP

(57) **CLAIM**

The ornamental design for a controller for electronic per-
cussion instrument, as shown.

DESCRIPTION

FIG. 1 is a perspective view of a controller for electronic
percussion instrument looking from the upper left-side
direction thereof;

FIG. 2 is a top view thereof;

FIG. 3 is a front view thereof;

FIG. 4 is a rear view thereof;

FIG. 5 is a bottom view thereof;

FIG. 6 is a right-side view thereof;

FIG. 7 is a left-side view thereof; and,

FIG. 8 is a top view of the controller for electronic percus-
sion instrument showing light transmission display section.

1 Claim, 5 Drawing Sheets

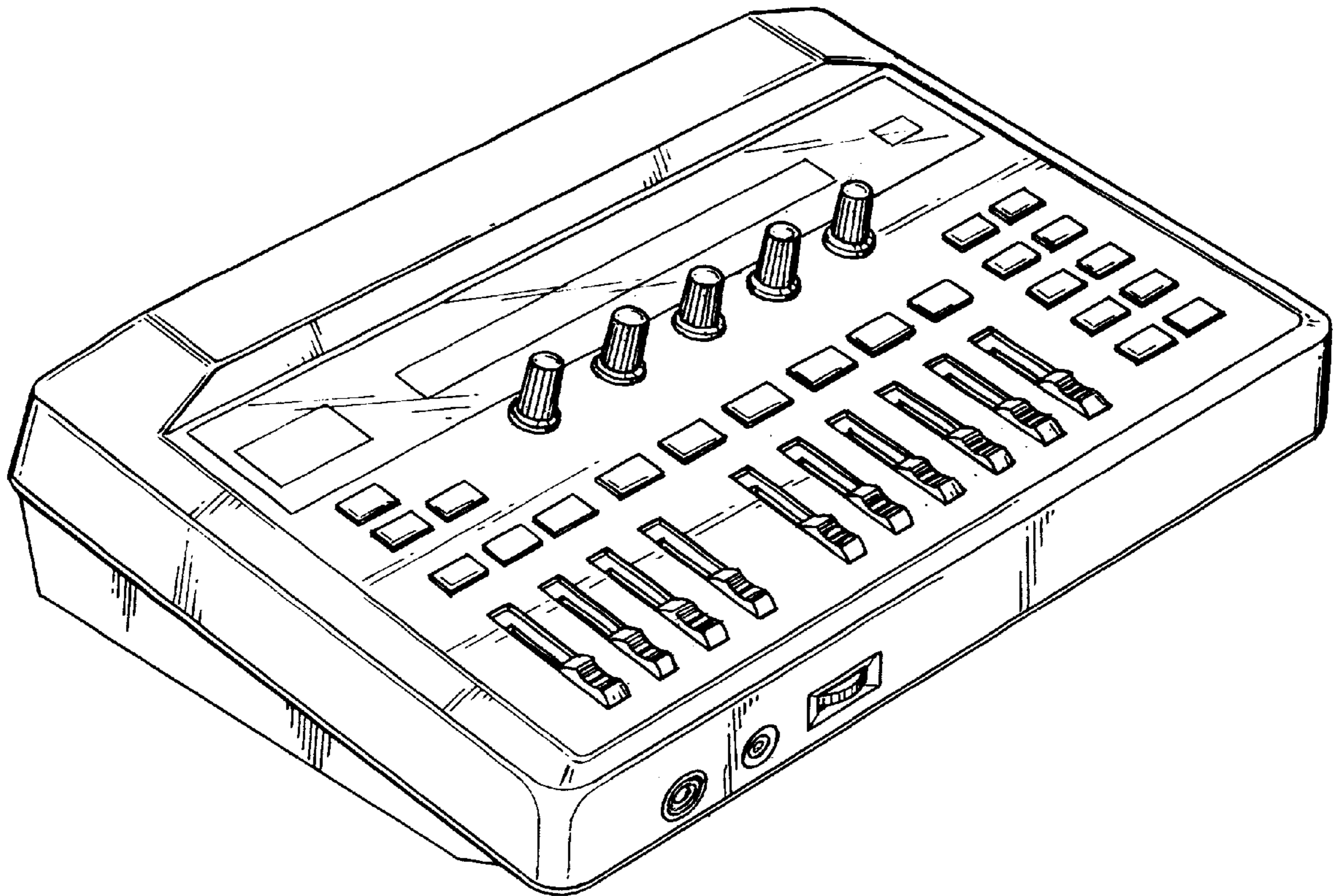

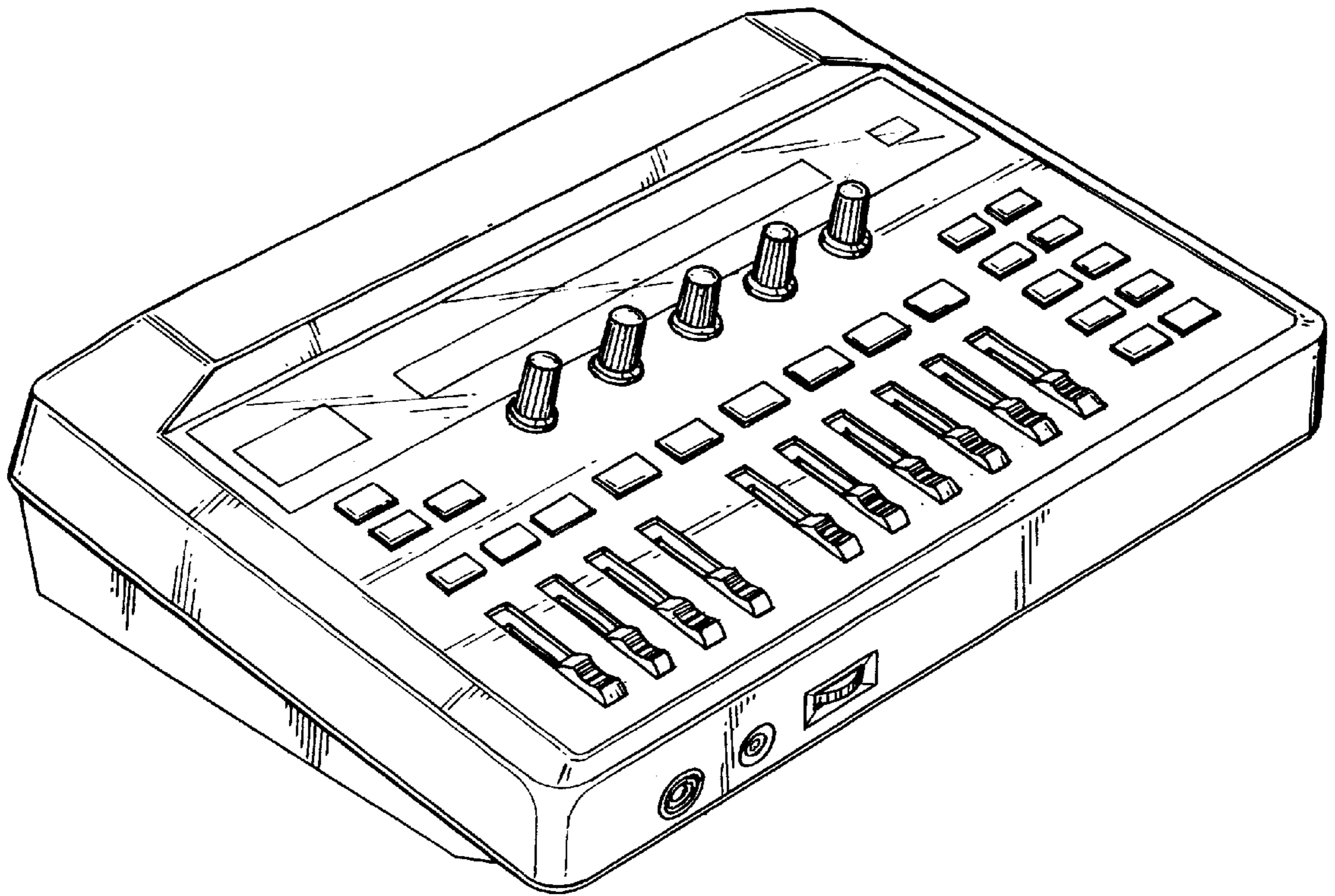

FIG. 1

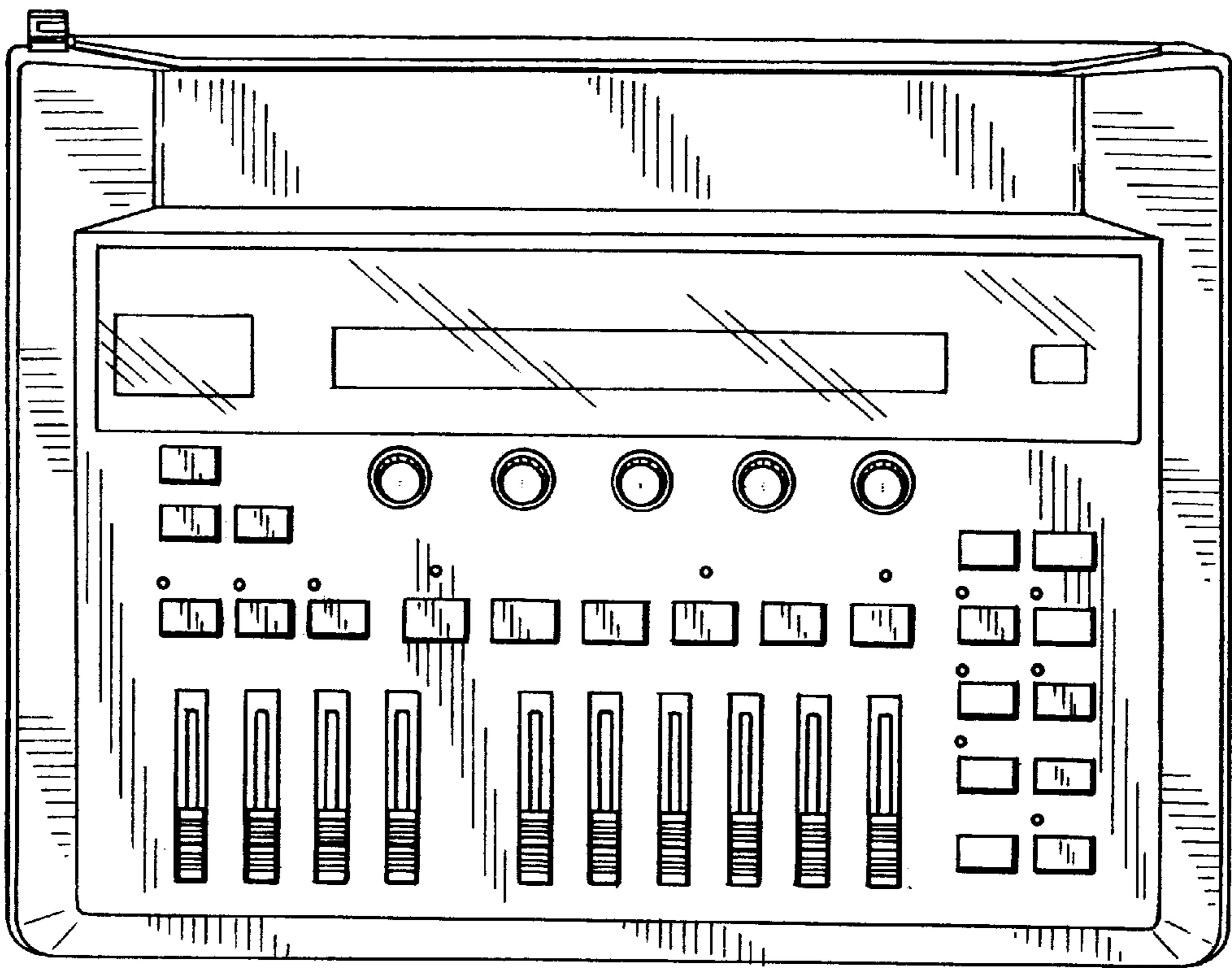

FIG. 2

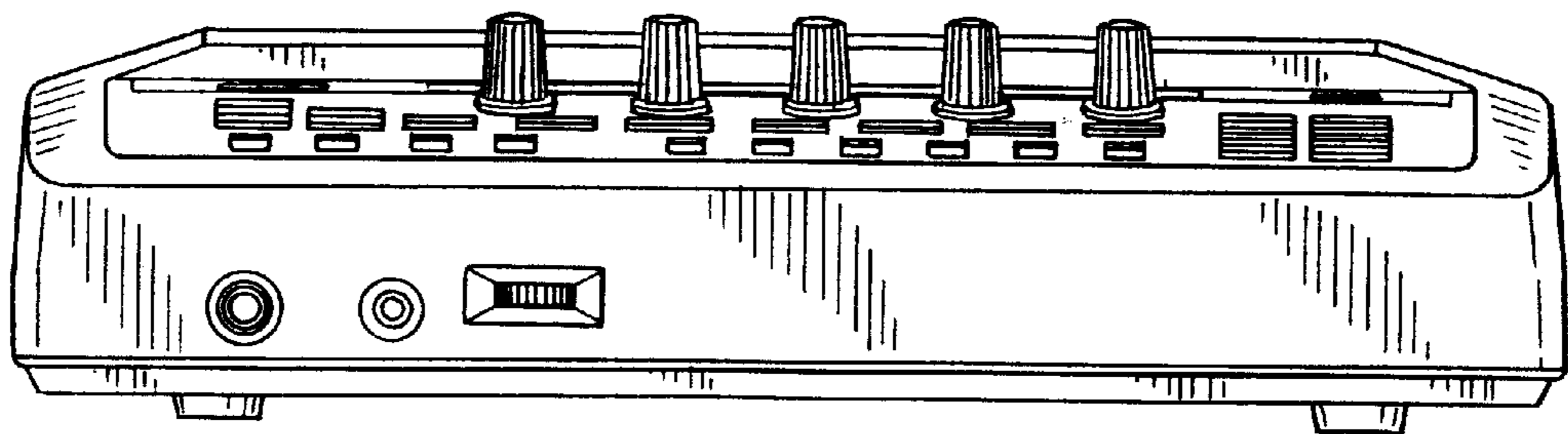

FIG. 3

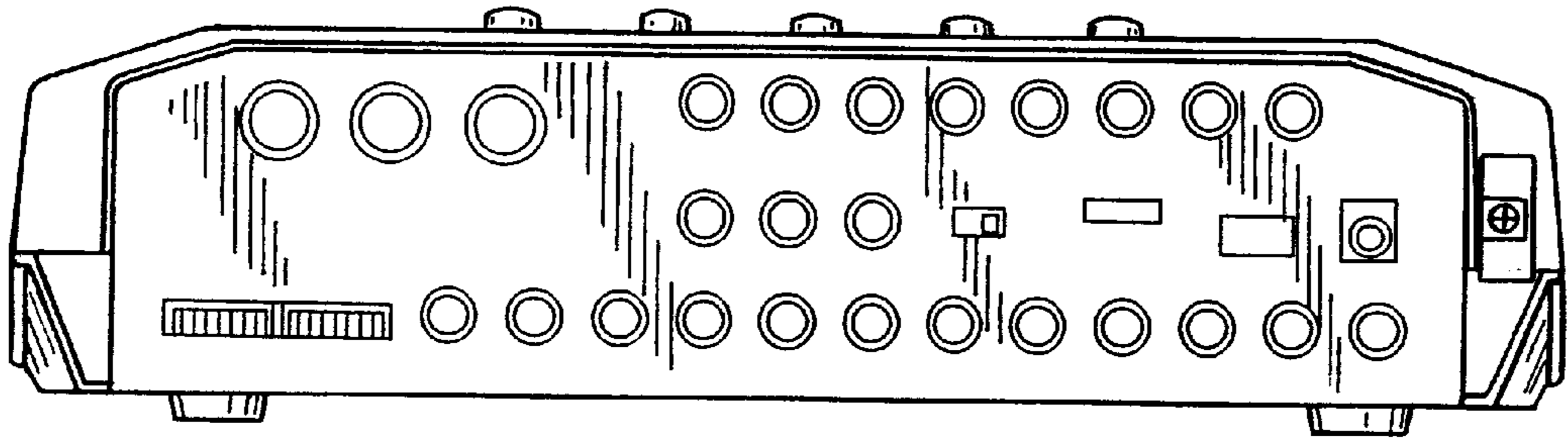

FIG. 4

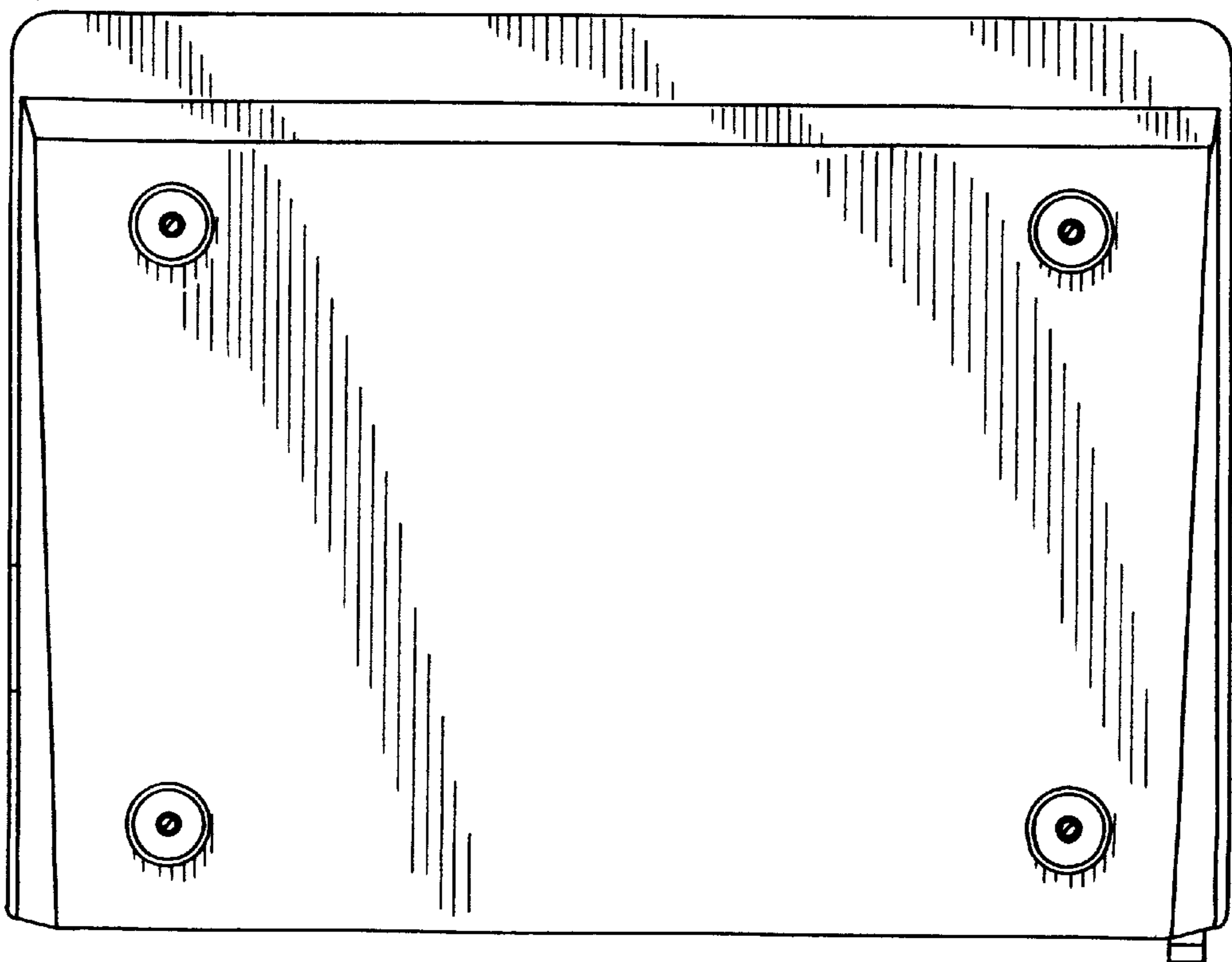

FIG. 5

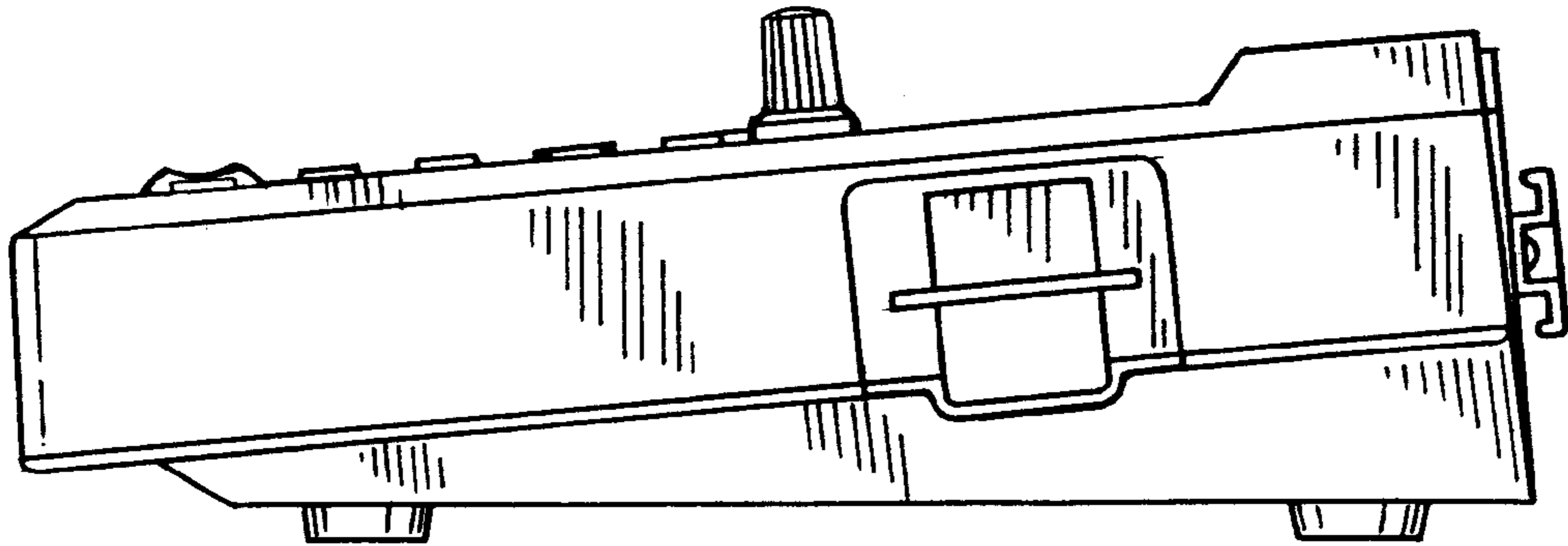

FIG. 6

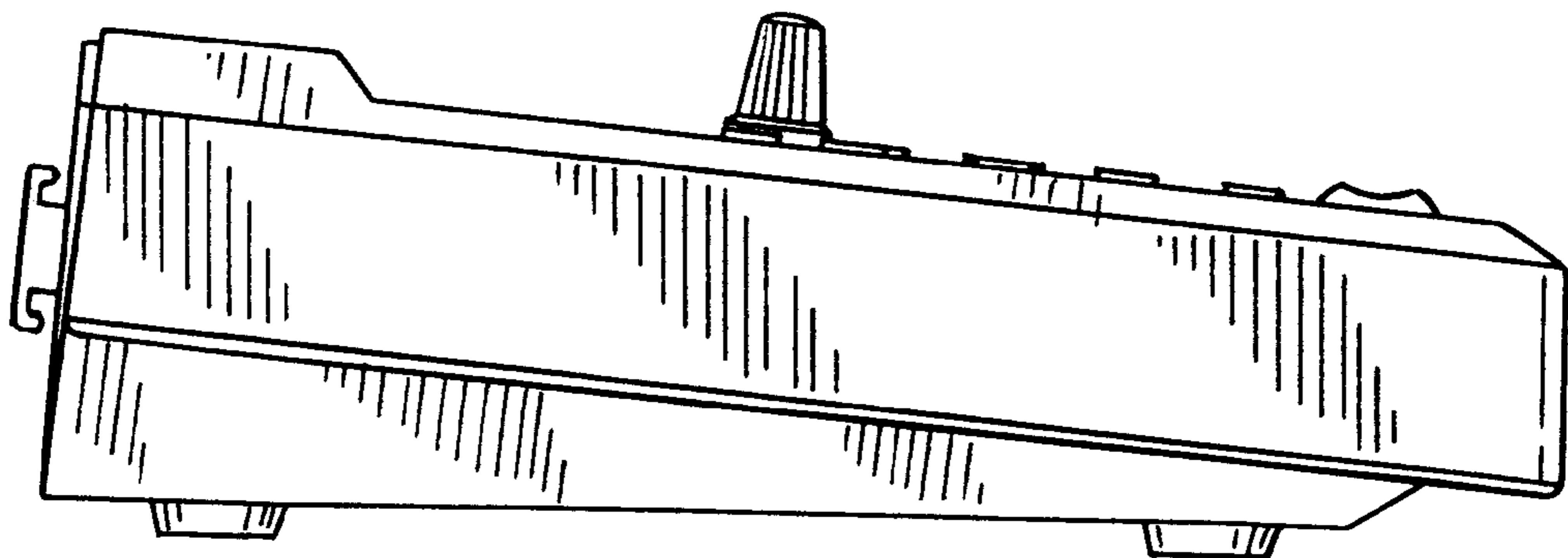

FIG. 7

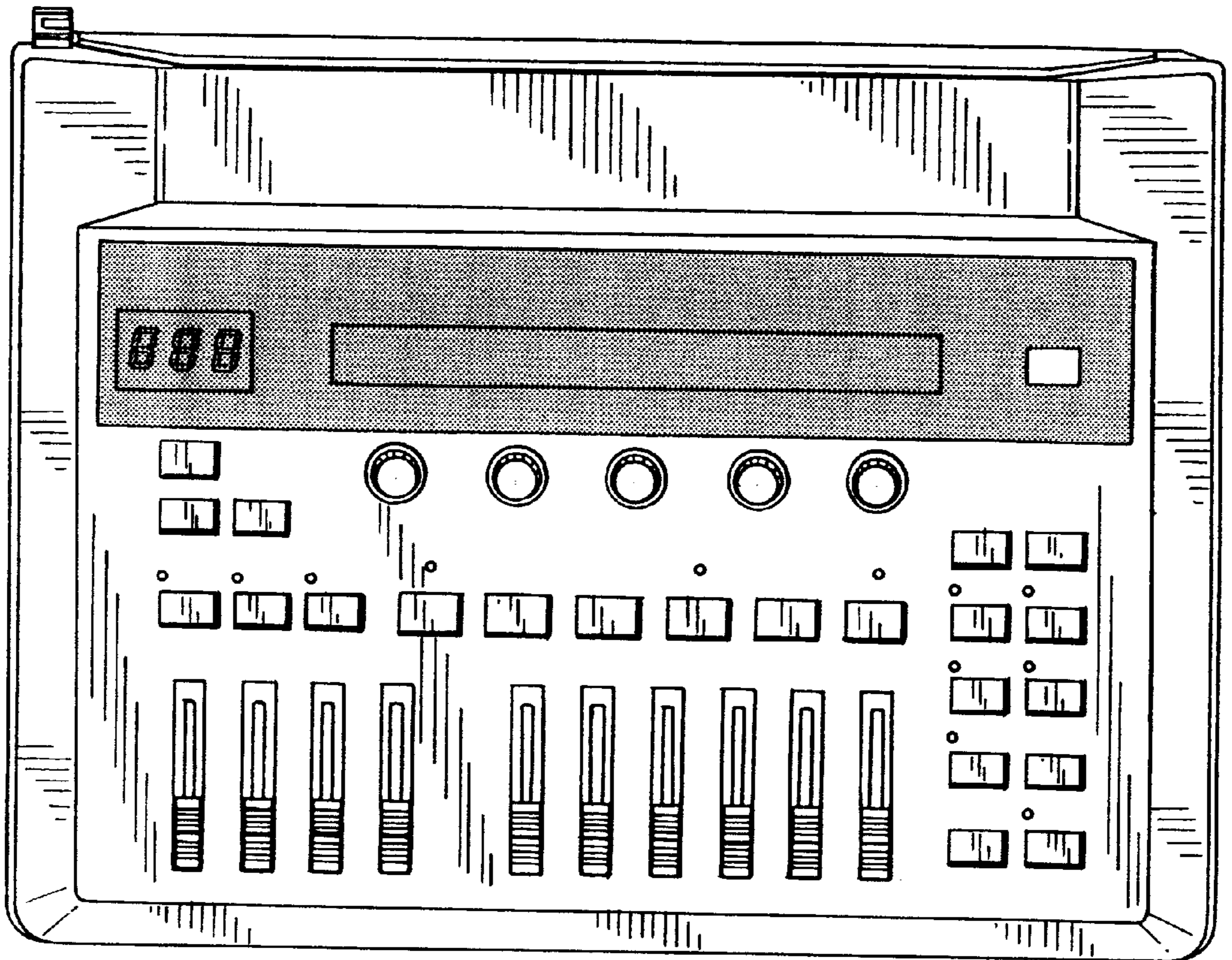

FIG. 8

UNITED STATES PATENT AND TRADEMARK OFFICE
CERTIFICATE OF CORRECTION

PATENT NO. : Des 444,460 S
DATED : July 3, 2001
INVENTOR(S) : Atsushi Kitazawa et al.

Page 1 of 1

It is certified that error appears in the above-identified patent and that said Letters Patent is hereby corrected as shown below:

Title page,

Item [30], **Foreign Application Priority Data**, "12-009414" should read
-- 9414/2000 --.

Signed and Sealed this

Sixth Day of August, 2002

Attest:

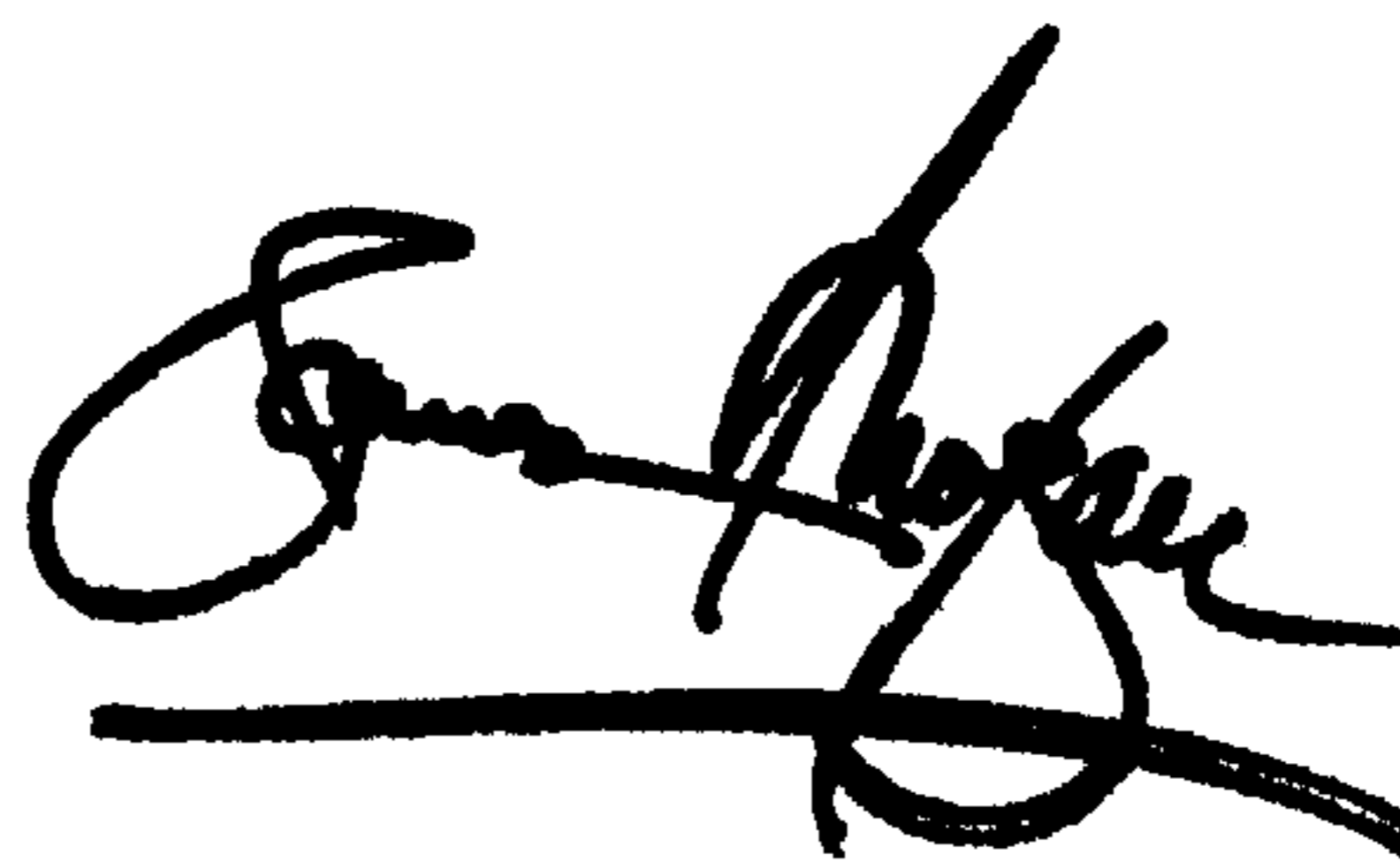

Attesting Officer

JAMES E. ROGAN
Director of the United States Patent and Trademark Office