



US00D444445S

(12) **United States Design Patent**
Schroeder

(10) **Patent No.:** **US D444,445 S**

(45) **Date of Patent:** **** Jul. 3, 2001**

(54) **TRUCK BED CAP**

(76) **Inventor:** **Hartmut W. Schroeder**, 11232 Martha Ann Dr., Rosmoor, CA (US) 90720

(**) **Term:** **14 Years**

(21) **Appl. No.:** **29/123,491**

(22) **Filed:** **May 18, 2000**

D. 328,062	*	7/1992	Burgess	D12/404
D. 329,837	*	9/1992	Rogers	D12/404
D. 379,173	*	5/1997	Quiniones	D12/404
D. 383,432	*	9/1997	Starr et al.	D12/404
D. 387,029	*	12/1997	Heinemann	D12/404
D. 388,049	*	12/1997	Reardon	D12/404
D. 403,652	*	1/1999	Starr et al.	D12/404
D. 407,062	*	3/1999	Patrovich	D12/404
D. 431,224	*	9/2000	Schroeder	D12/404
D. 431,225	*	9/2000	Perlman et al.	D12/404

Related U.S. Application Data

(62) Division of application No. 29/077,268, filed on Oct. 1, 1997, now Pat. No. Des. 431,224.

(51) **LOC (7) Cl.** **12-16**

(52) **U.S. Cl.** **D12/404**

(58) **Field of Search** D12/401, 403-405; 296/10, 99.1, 100, 105-108, 156, 164-165, 175, 185-186, 103, 210, 25-27

* cited by examiner

Primary Examiner—Stacia Cadmus

(74) *Attorney, Agent, or Firm*—Fulwider Patton Lee & Utecht, LLP

(57) **CLAIM**

The ornamental design for a truck bed cap, as shown and described.

DESCRIPTION

FIG. 1 is a perspective view of the truck bed cap showing my new design;

FIG. 2 is a side plan view thereof;

FIG. 3 is a front plan view thereof;

FIG. 4 is a back plan view thereof;

FIG. 5 is a top plan view thereof;

FIG. 6 is a bottom plan view thereof; and,

FIG. 7 is a cross-sectional view thereof taken along line 7-7 of FIG. 1.

The broken line showing of environment is for illustrative purposes only and forms no part of the claimed design.

(56) **References Cited**

U.S. PATENT DOCUMENTS

D. 244,182	*	5/1977	Skidmore	D12/404
D. 254,905	*	5/1980	Collins	D12/404
D. 271,757	*	12/1983	Miller	D12/404
D. 281,488	*	11/1985	Collins	D12/404
D. 298,818	*	12/1988	Silliker	D12/404
D. 317,889	*	7/1991	Gentzhorn	D12/404
D. 324,015	*	2/1992	Quiniones	D12/404
D. 325,366	*	4/1992	Mansberger	D12/404
D. 325,551	*	4/1992	Quiniones	D12/404
D. 326,441	*	5/1992	Rogers	D12/404
D. 328,049	*	7/1992	Sturtevant	D12/404

1 Claim, 4 Drawing Sheets

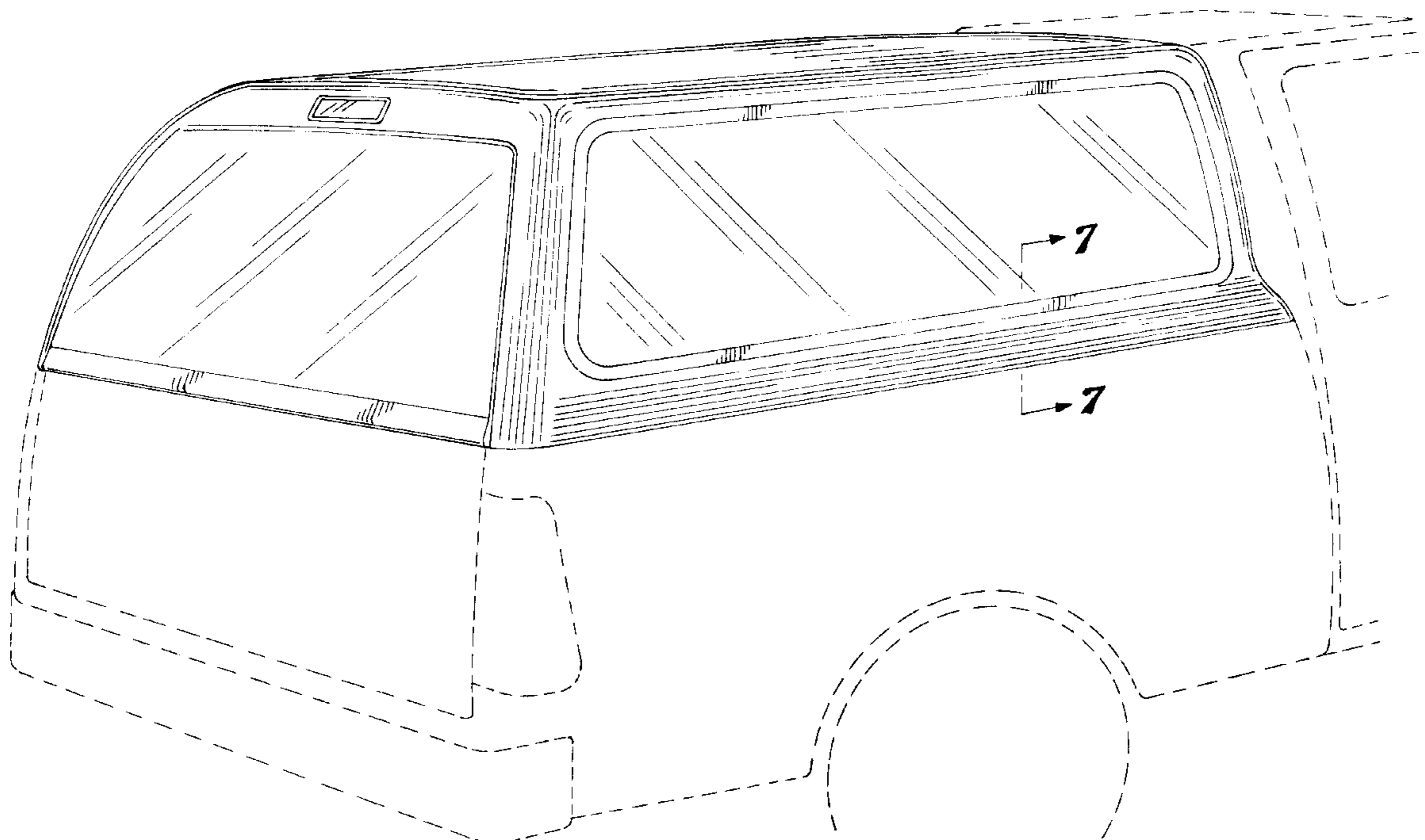

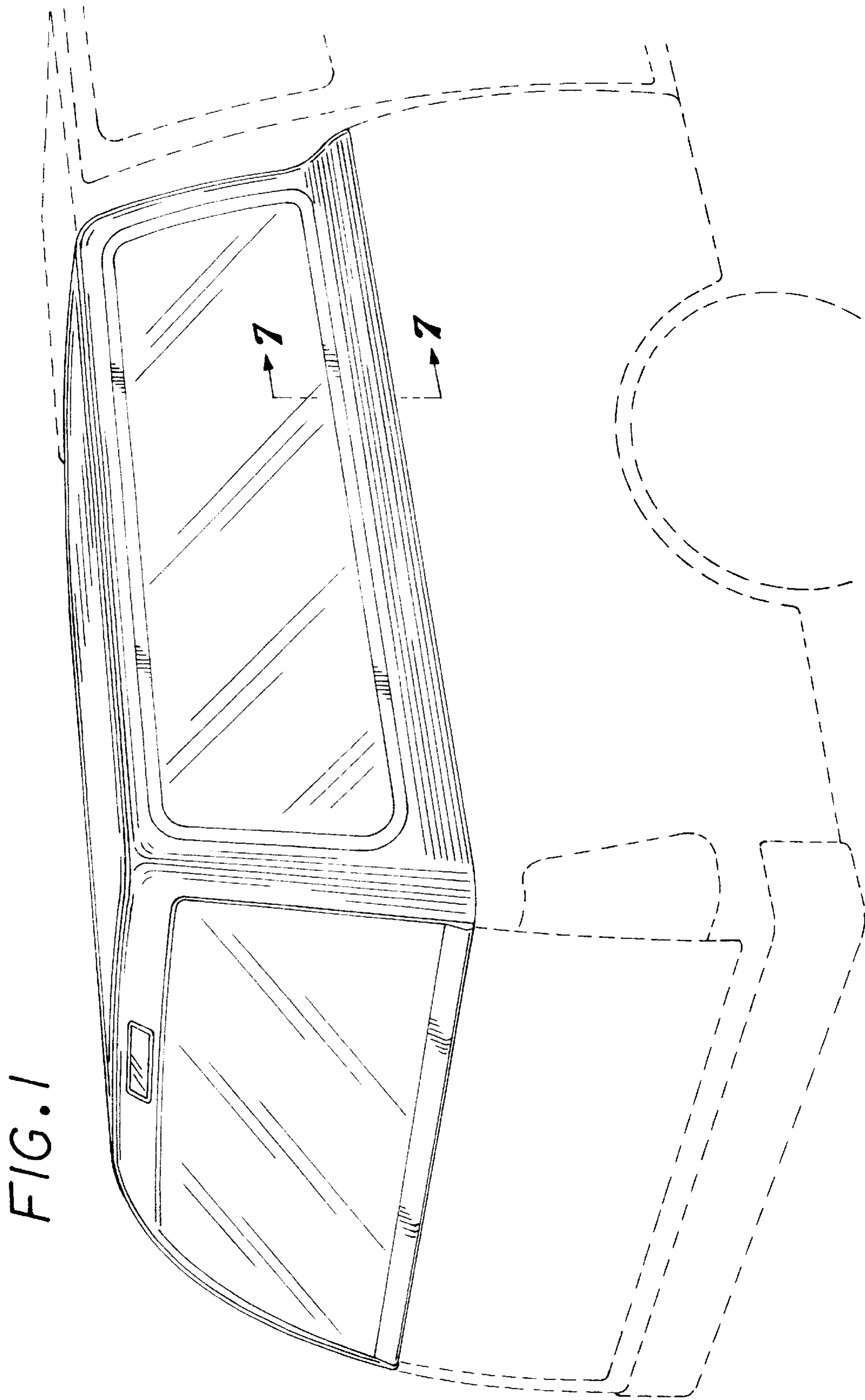

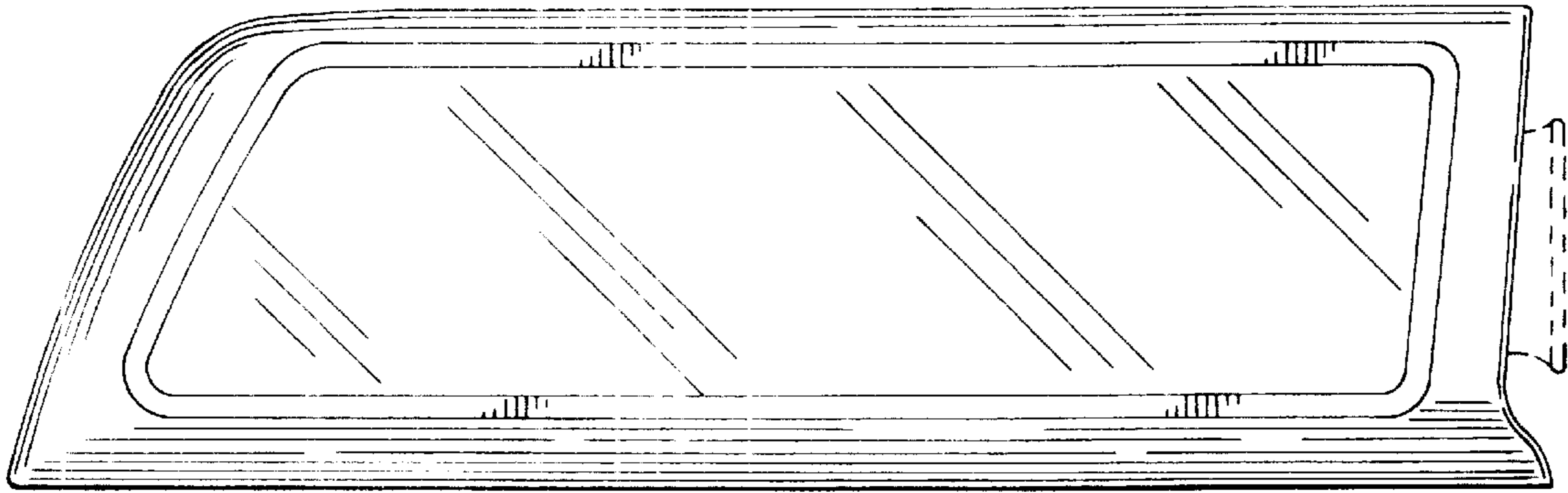

FIG. 2

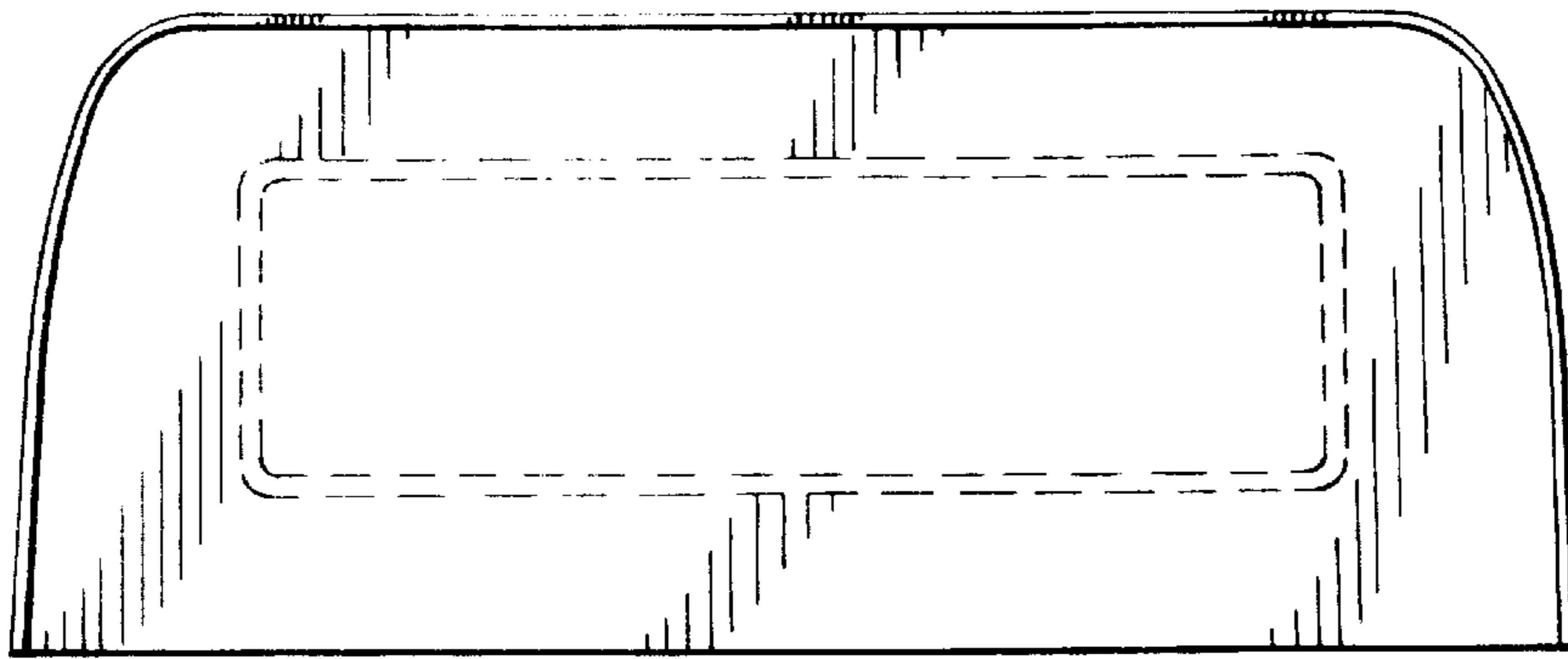

FIG. 3

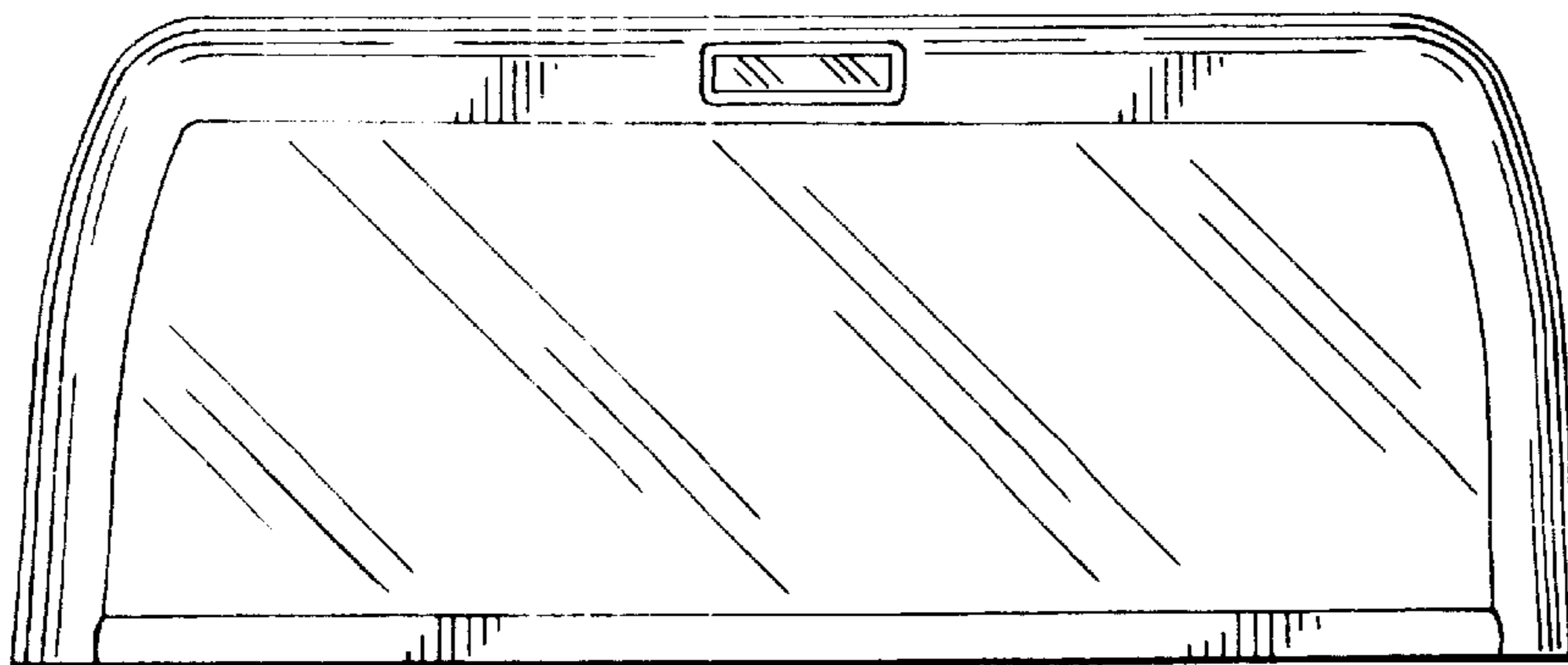

FIG. 4

FIG. 5

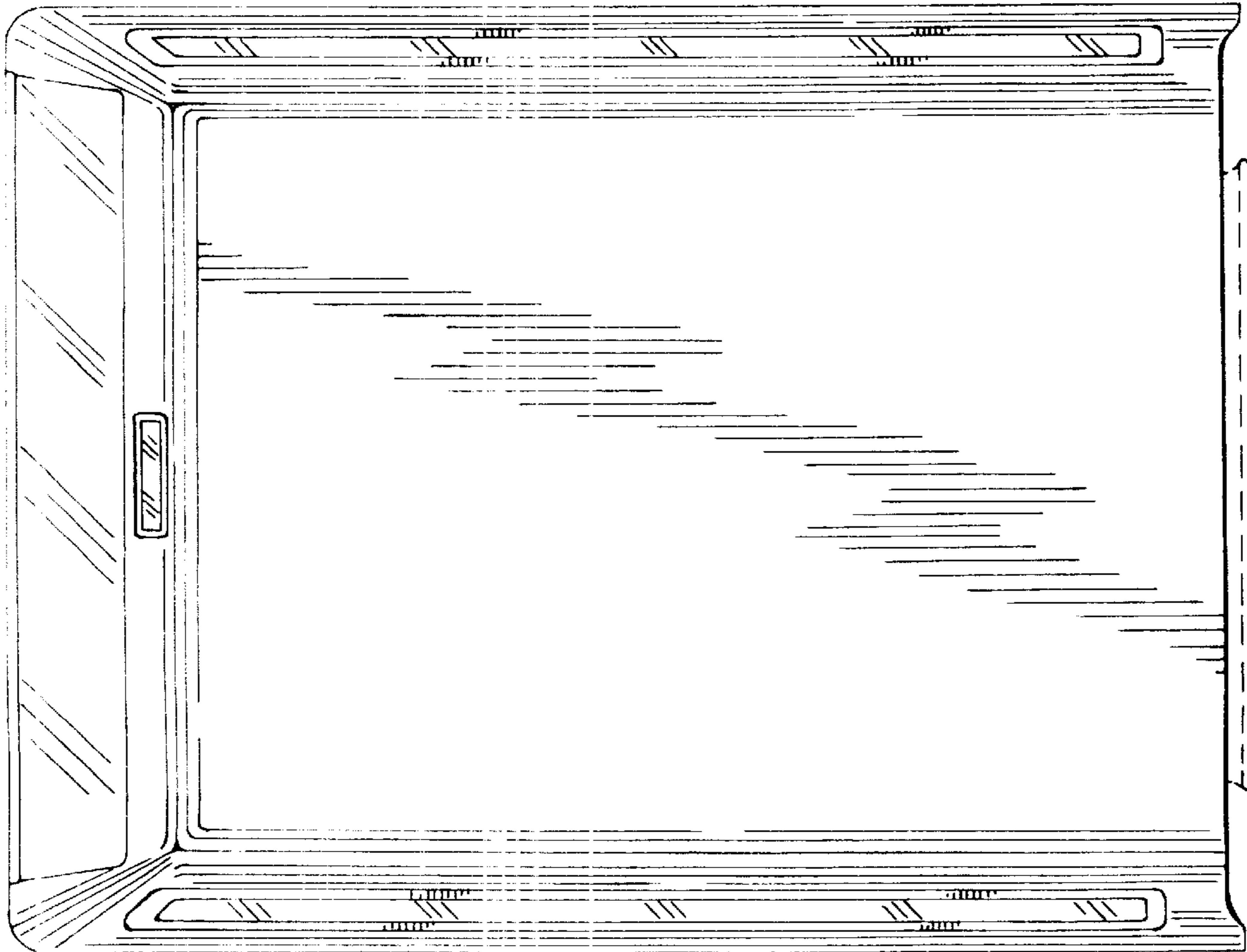
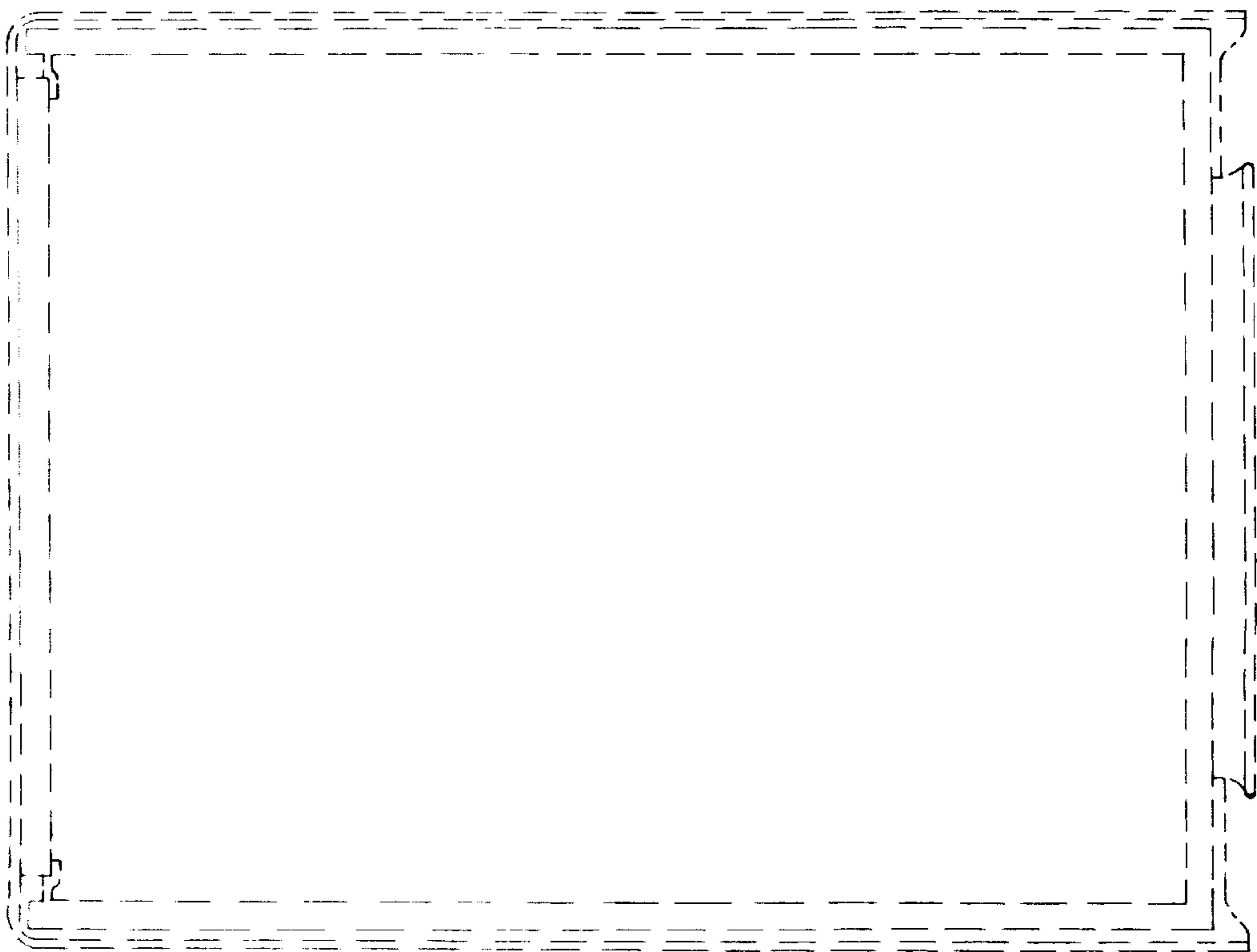

FIG. 6



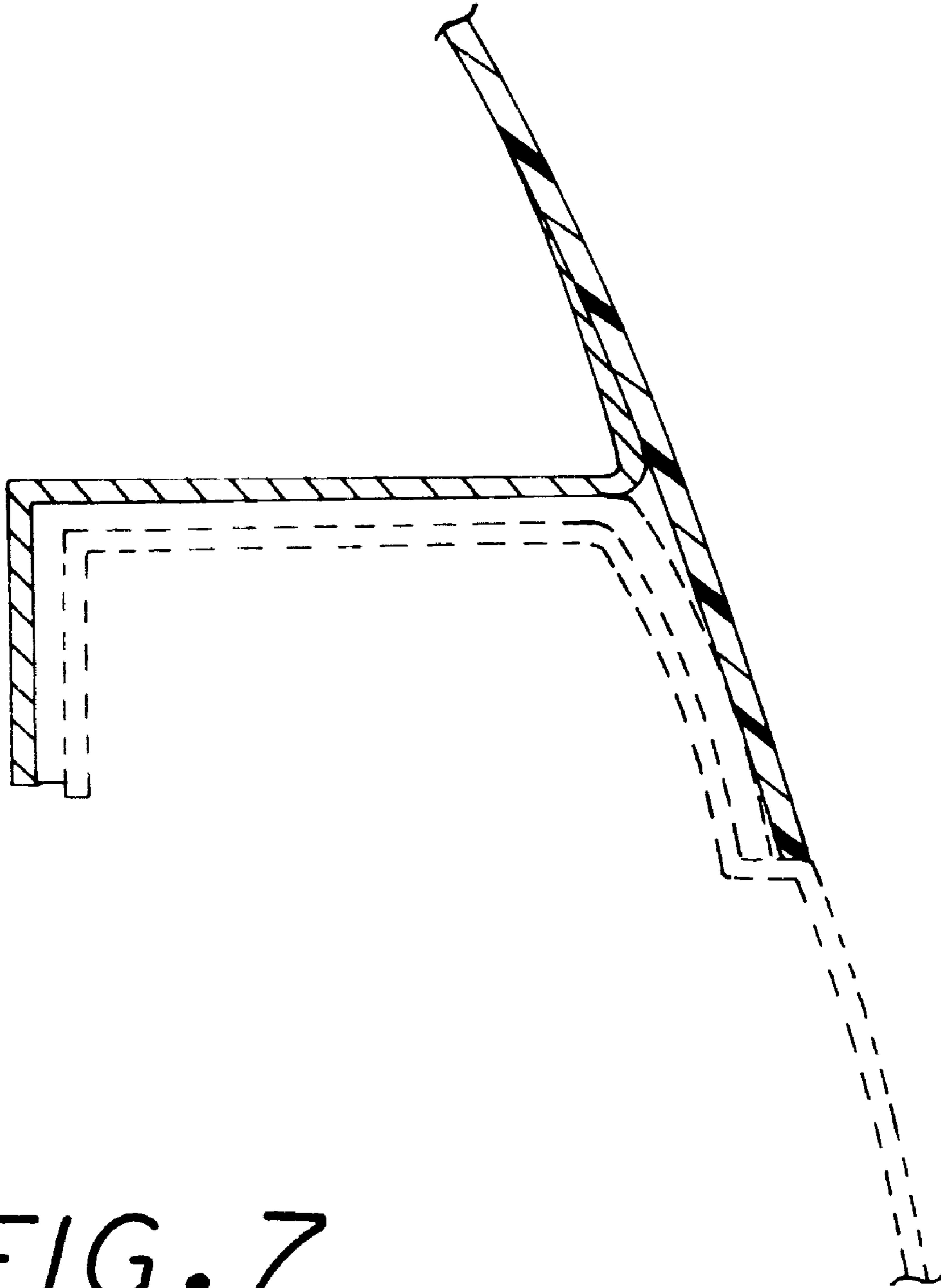

FIG. 7