



US00D444258S

(12) **United States Design Patent**  
**Bradford et al.**

(10) **Patent No.:** **US D444,258 S**

(45) **Date of Patent:** **\*\* Jun. 26, 2001**

(54) **WALL-MOUNTED LIGHTING FIXTURE**

(74) *Attorney, Agent, or Firm*—Carter & Schnedler, P.A.

(75) Inventors: **Reed A. Bradford**, Hendersonville;  
**James H. Toney**, Canton, both of NC  
(US)

(57) **CLAIM**

The ornamental design for a wall-mounted lighting fixture,  
as shown and described.

(73) Assignee: **General Electric Company**,  
Schenectady, NY (US)

**DESCRIPTION**

(\*\*) Term: **14 Years**

(21) Appl. No.: **29/131,329**

(22) Filed: **Oct. 17, 2000**

(51) **LOC (7) Cl.** ..... **26-03**

(52) **U.S. Cl.** ..... **D26/87**

(58) **Field of Search** ..... D26/72, 87, 92,  
D26/142, 155; 362/147, 432

FIG. 1 is a three-dimensional view, generally from the right  
front, of a wall-mounted lighting fixture, showing our new  
design;

FIG. 2 is another three-dimensional view, generally from the  
top right front, thereof;

FIG. 3 is a front elevational view thereof;

FIG. 4 is a left side elevational view thereof;

FIG. 5 is a right side elevational view thereof;

FIG. 6 is a top plan view thereof;

FIG. 7 is a bottom plan view thereof;

FIG. 8 is a rear elevational view thereof;

FIG. 9 is a three-dimensional view, generally from the right  
front, of a second embodiment of our new design, the top  
plan view and the rear elevational view of the second  
embodiment being identical to FIGS. 6 and 8, respectively;

FIG. 10 is another three-dimensional view, generally from  
the top right front, thereof;

FIG. 11 is a front elevational view thereof;

FIG. 12 is a left side elevational view thereof, the right side  
being a mirror image; and,

FIG. 13 is a bottom plan view thereof.

(56) **References Cited**

**U.S. PATENT DOCUMENTS**

D. 357,997 \* 5/1995 Wegzyn ..... D26/85

D. 432,700 \* 10/2000 Avila et al. .... D26/87

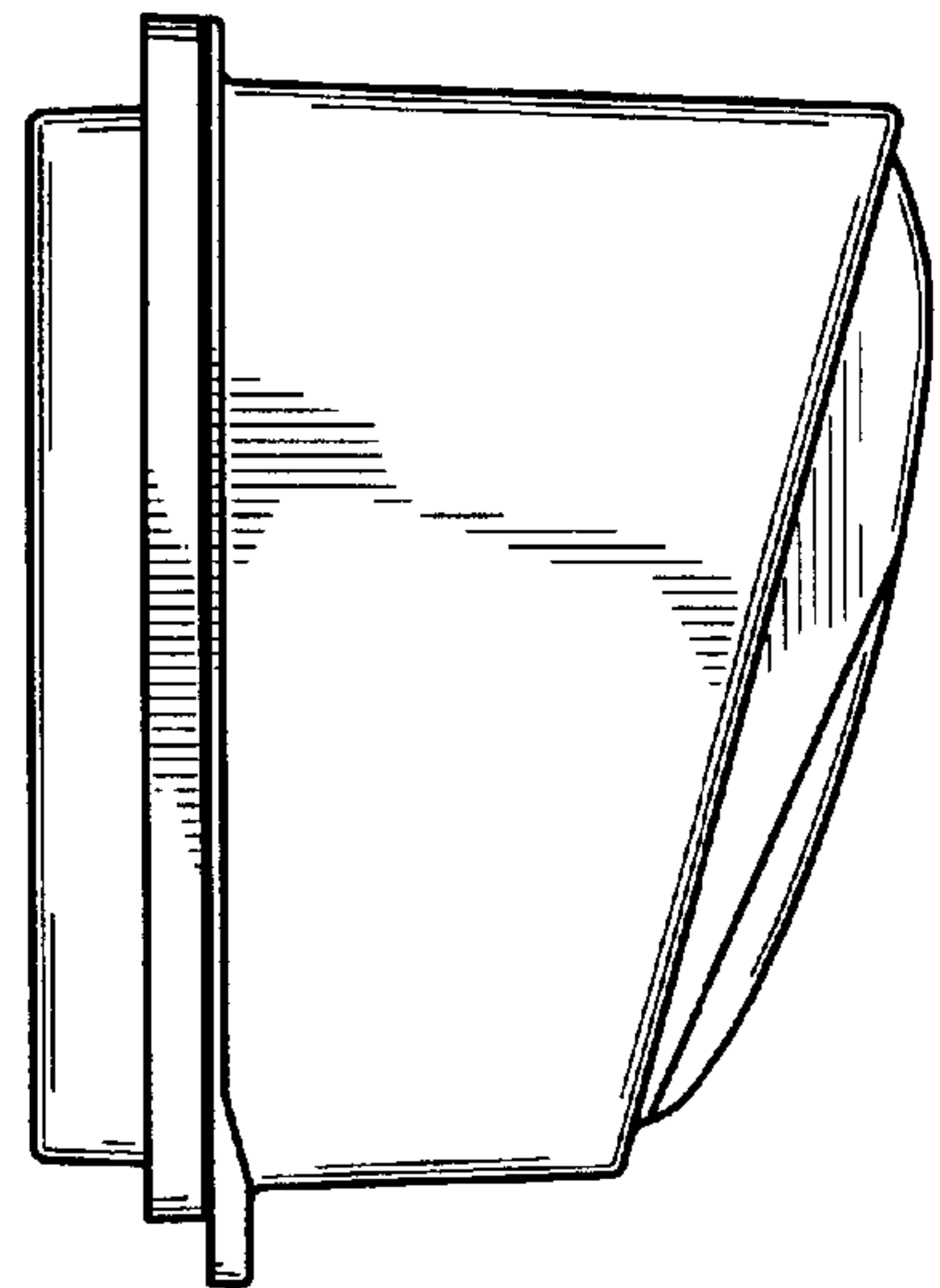
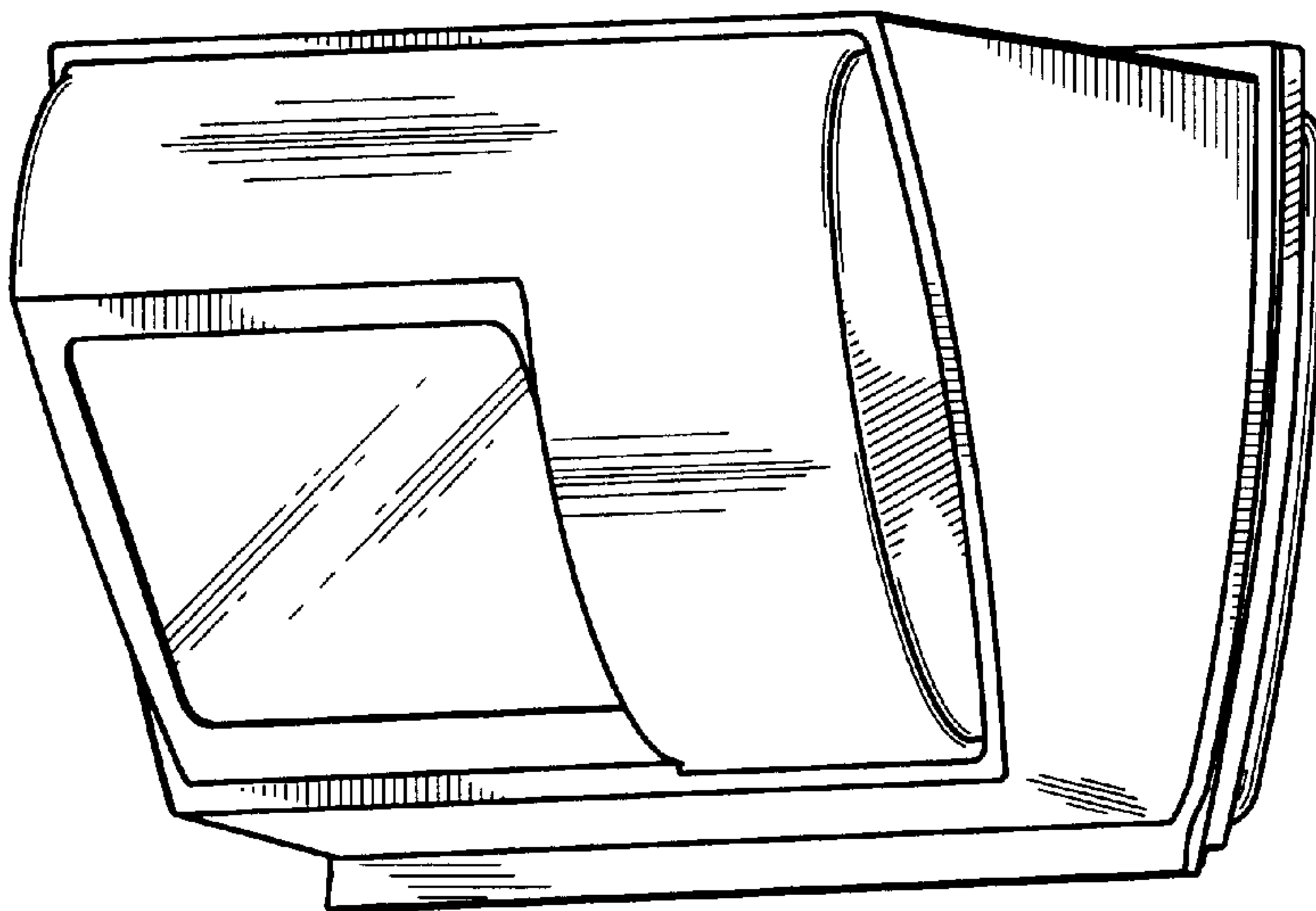
**OTHER PUBLICATIONS**

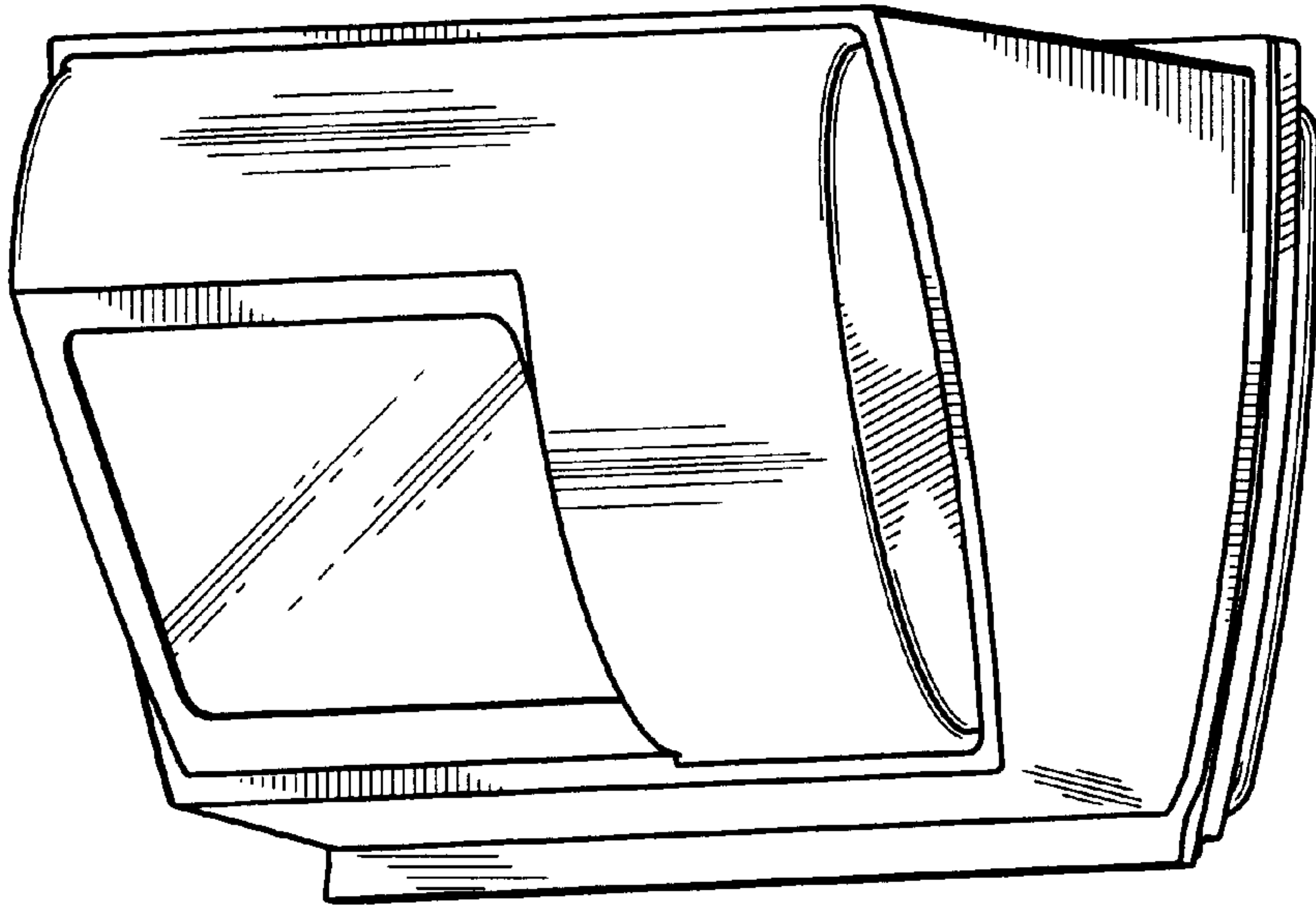
Illuminotecnica lighting magazine, May/Jun. 1998, p. IX/89,  
wall lamp, wall lamp, bottom left.\*

\* cited by examiner

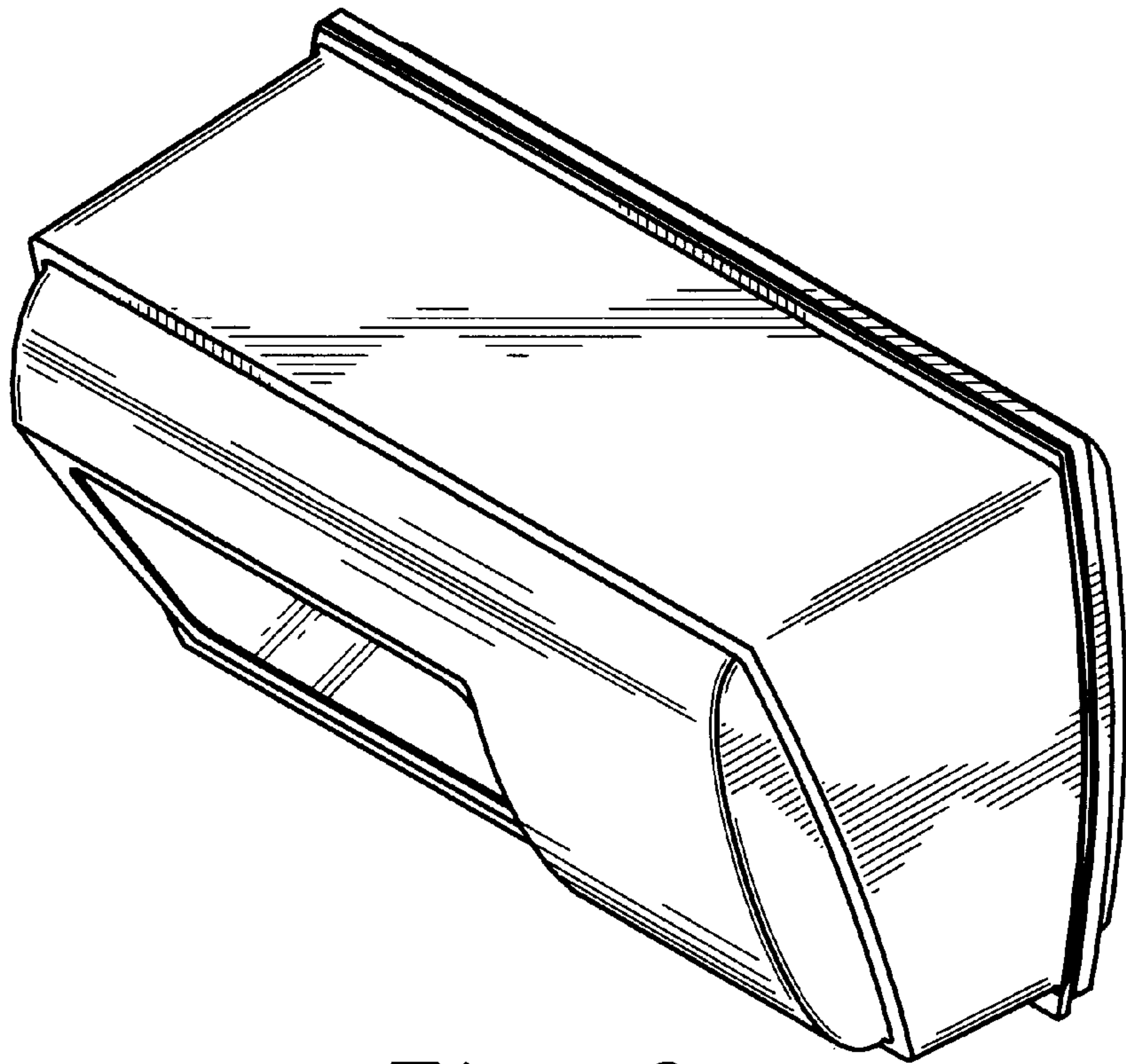
*Primary Examiner*—Susan J. Lucas

**1 Claim, 7 Drawing Sheets**

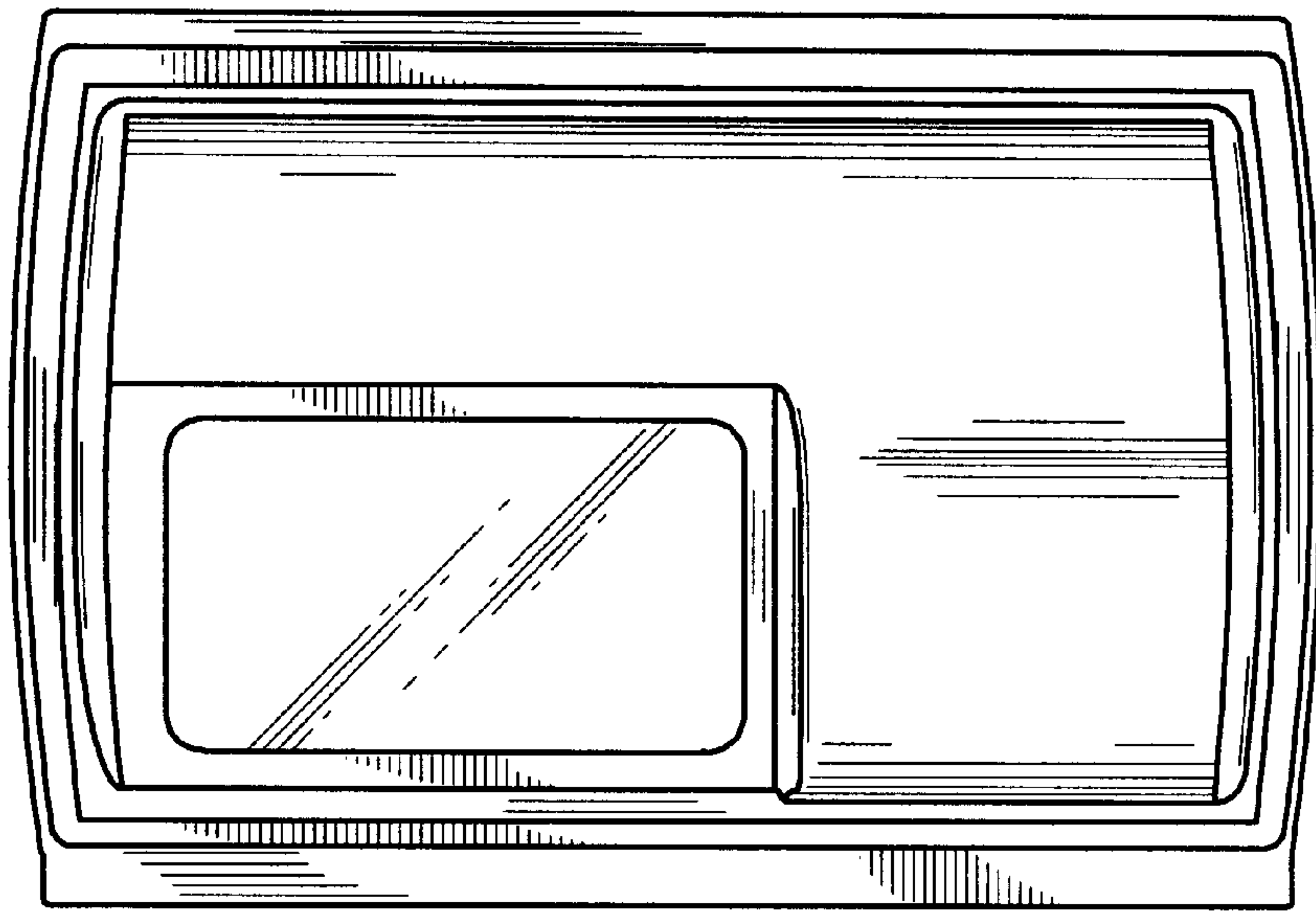




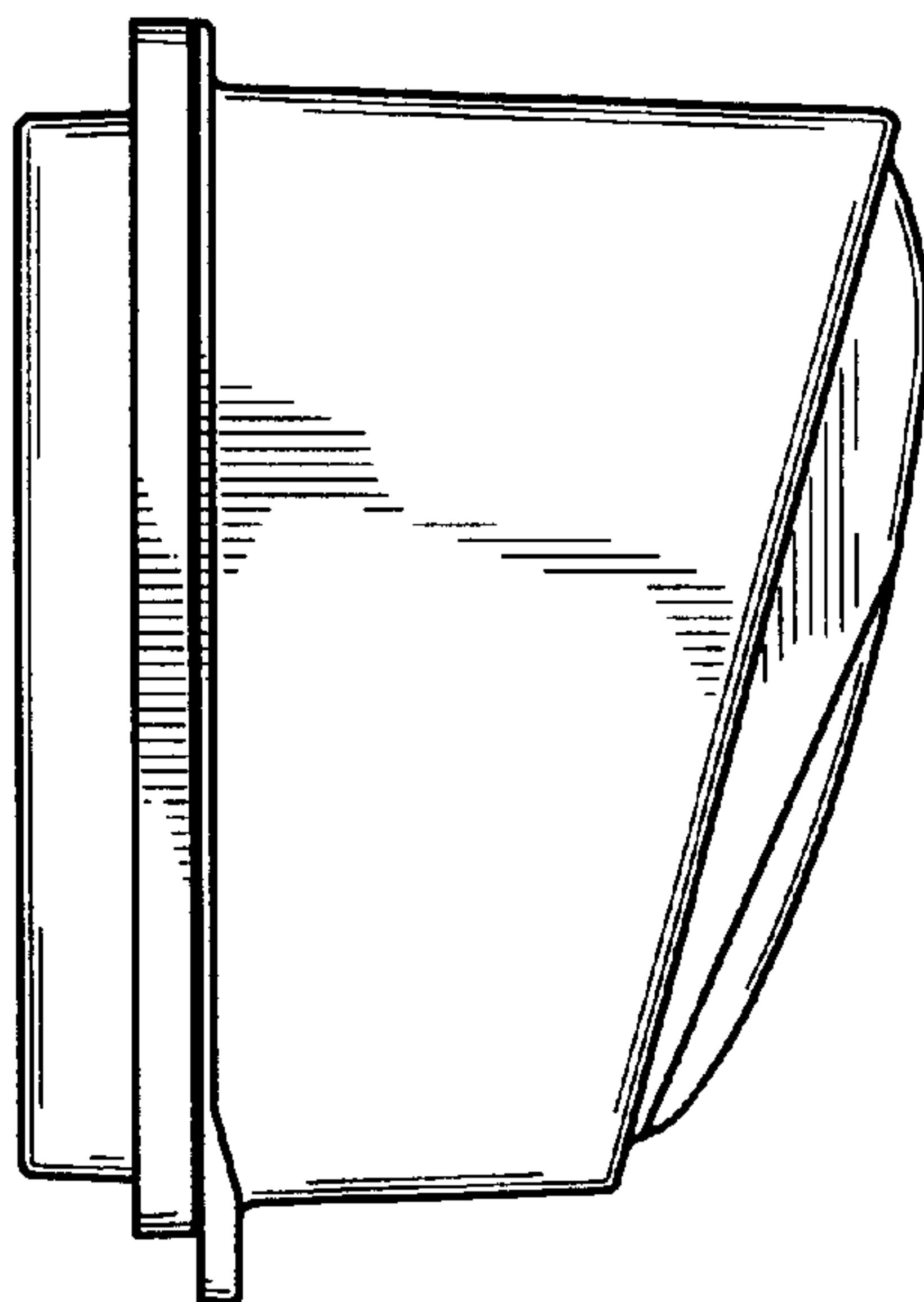
*Fig. 1*



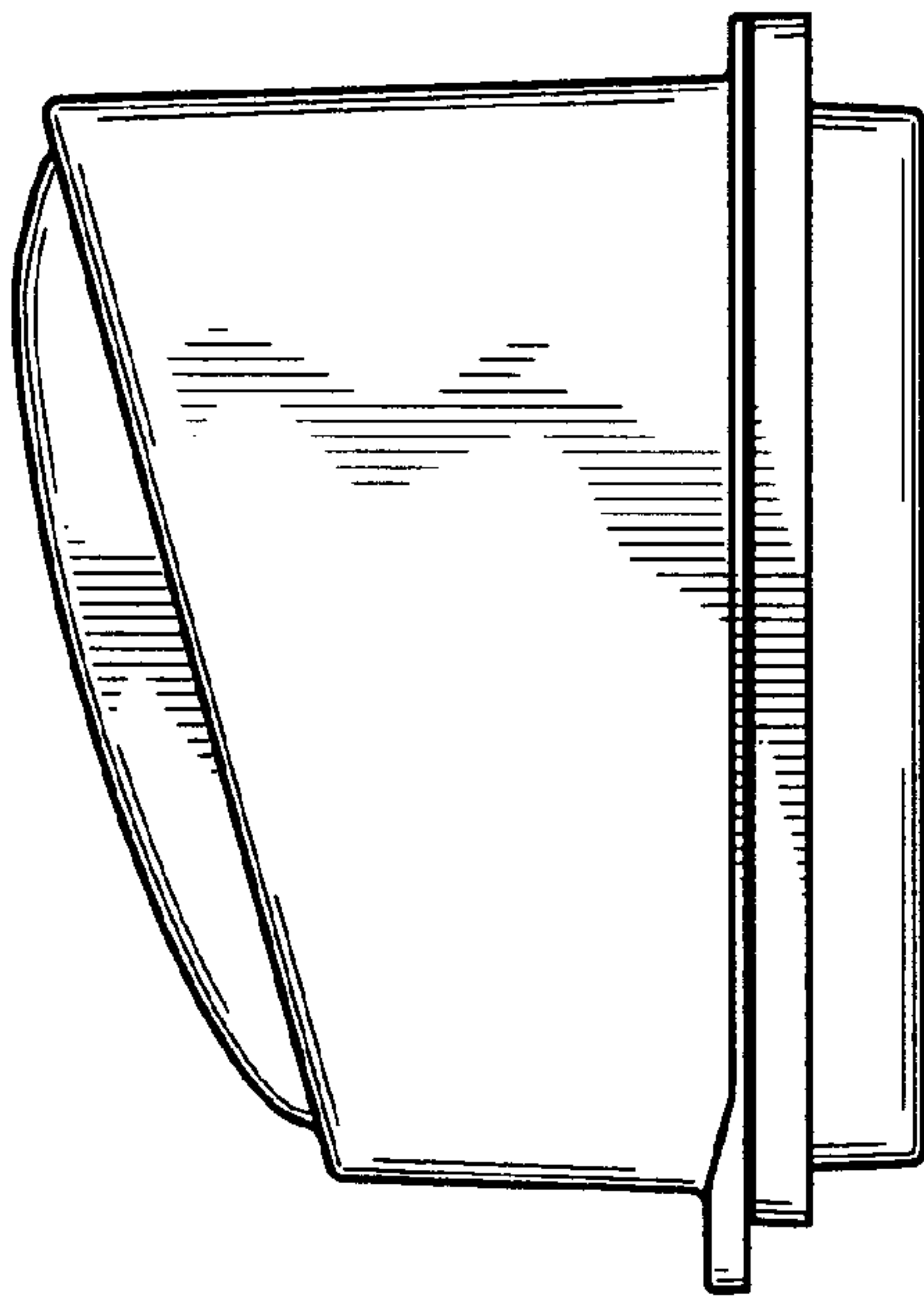
*Fig. 2*



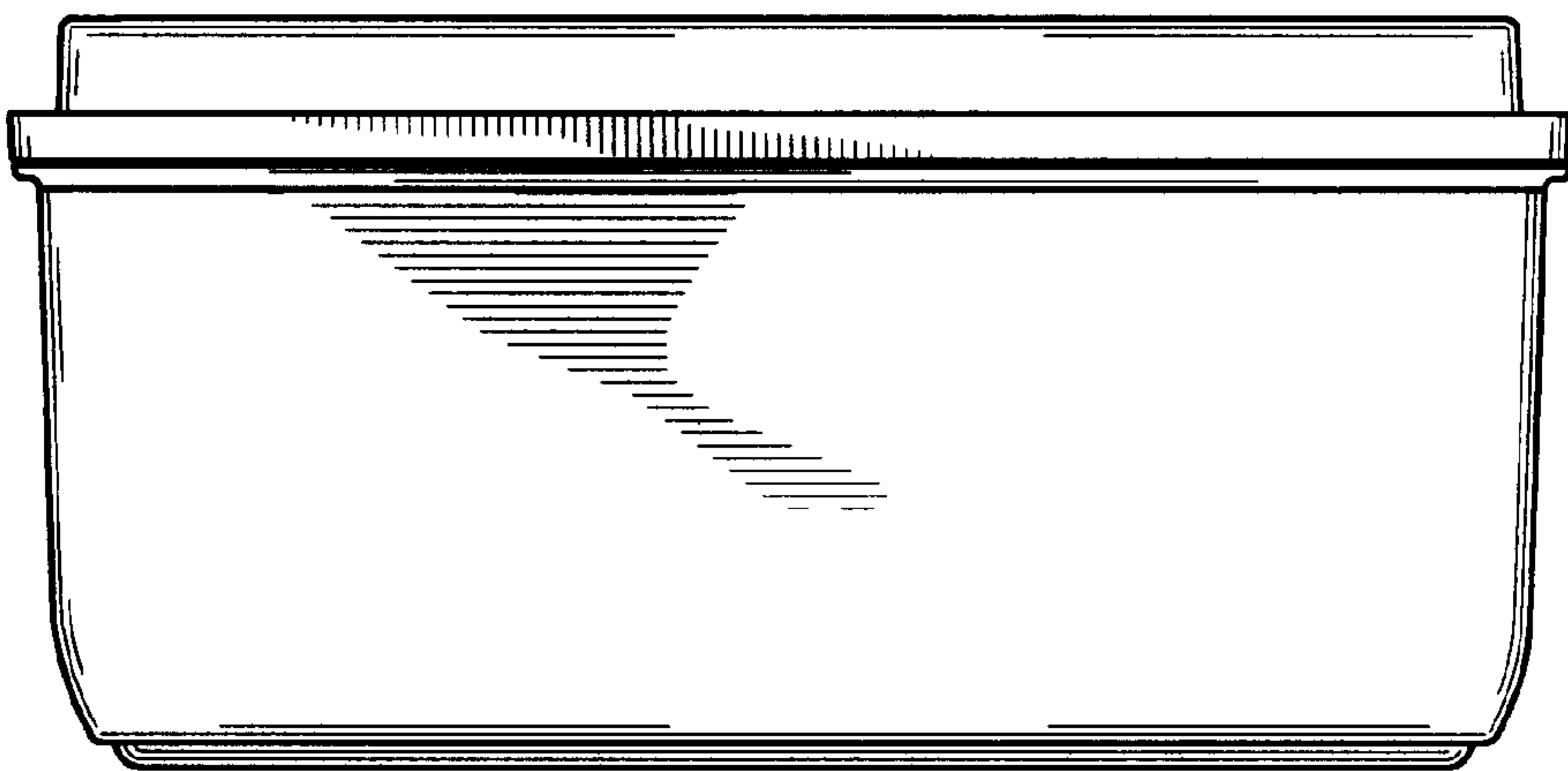
*Fig. 3*



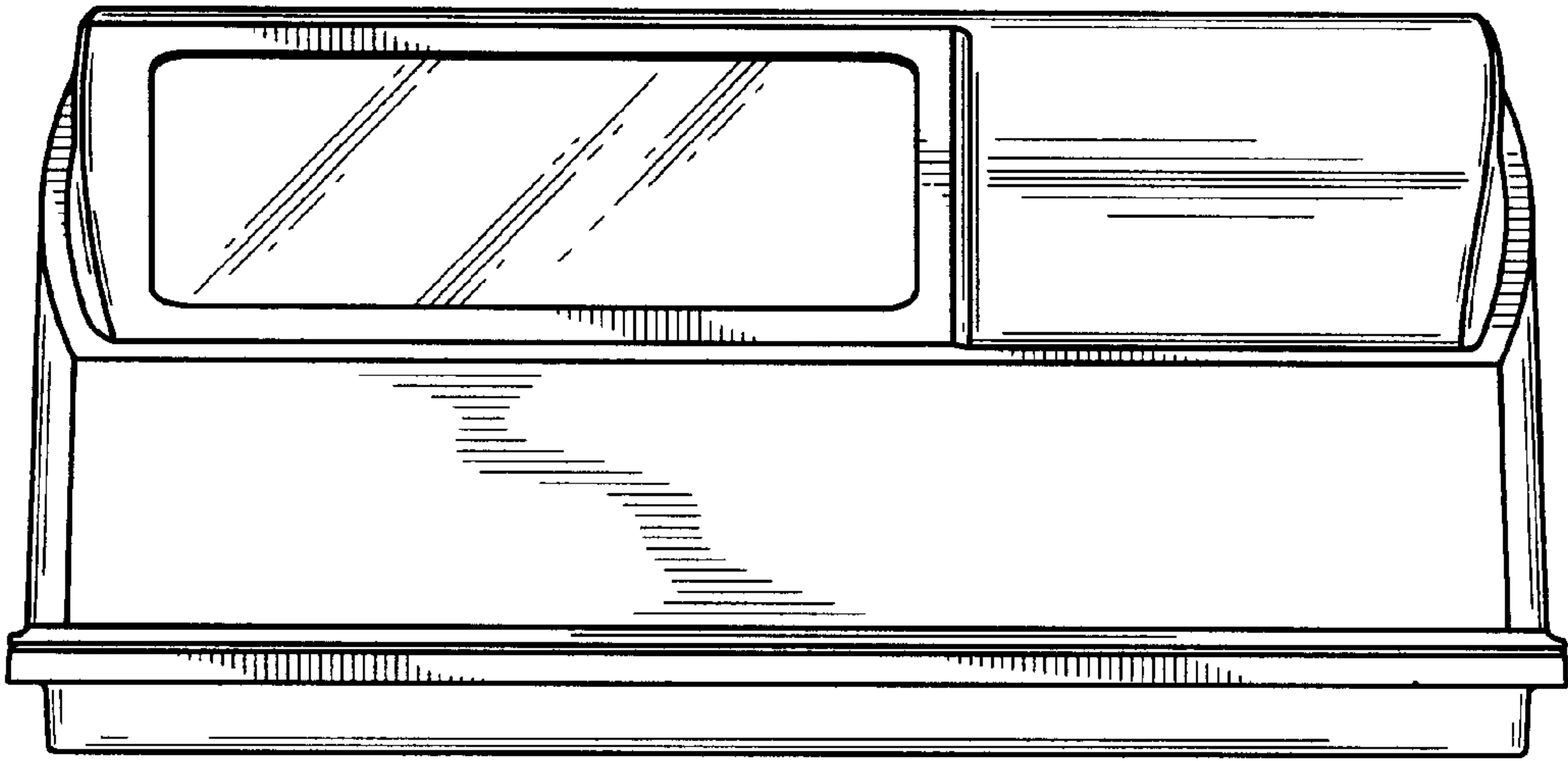
*Fig. 4*



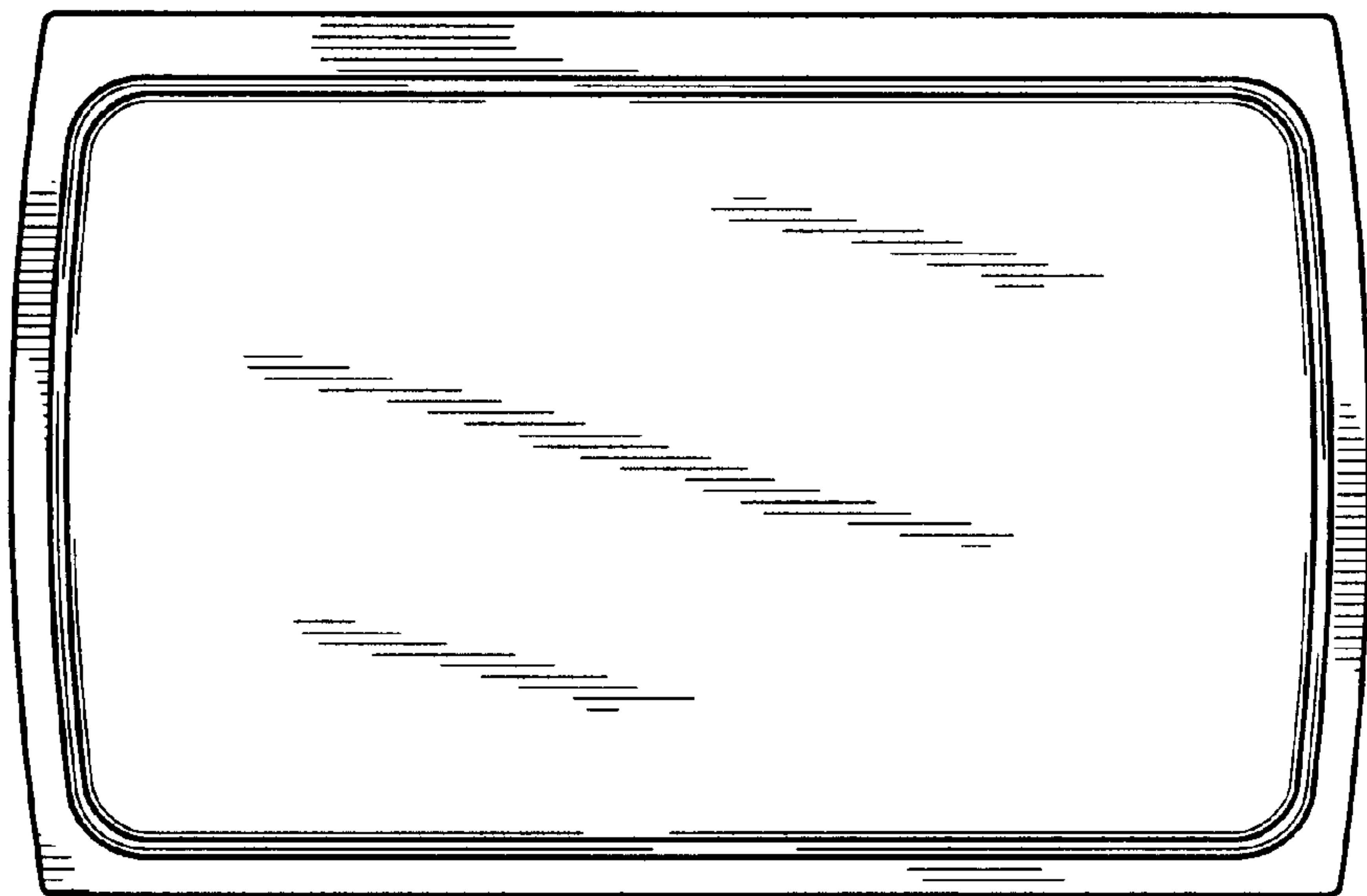
*Fig. 5*



*Fig. 6*

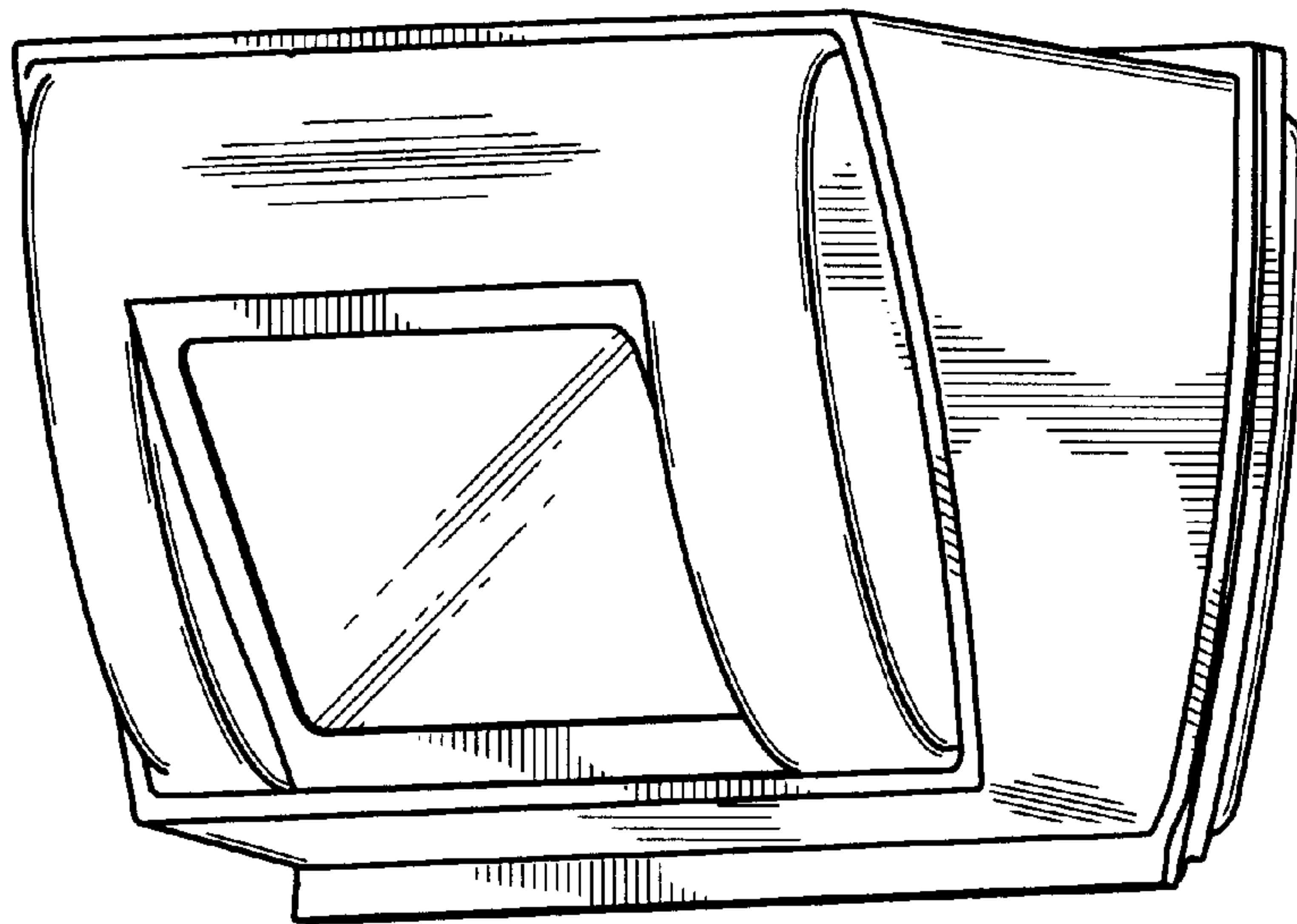


*Fig. 7*

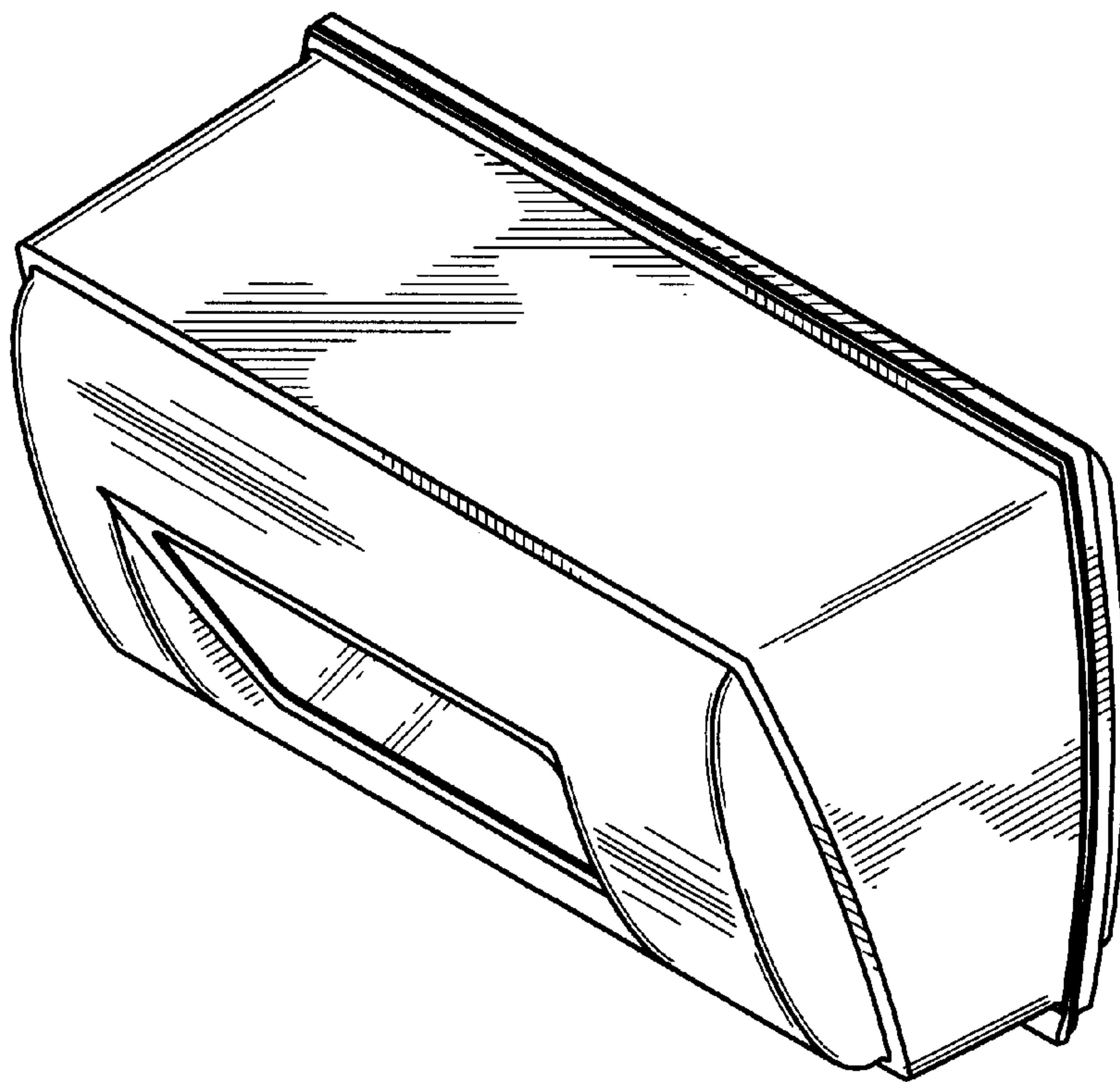


*Fig. 8*

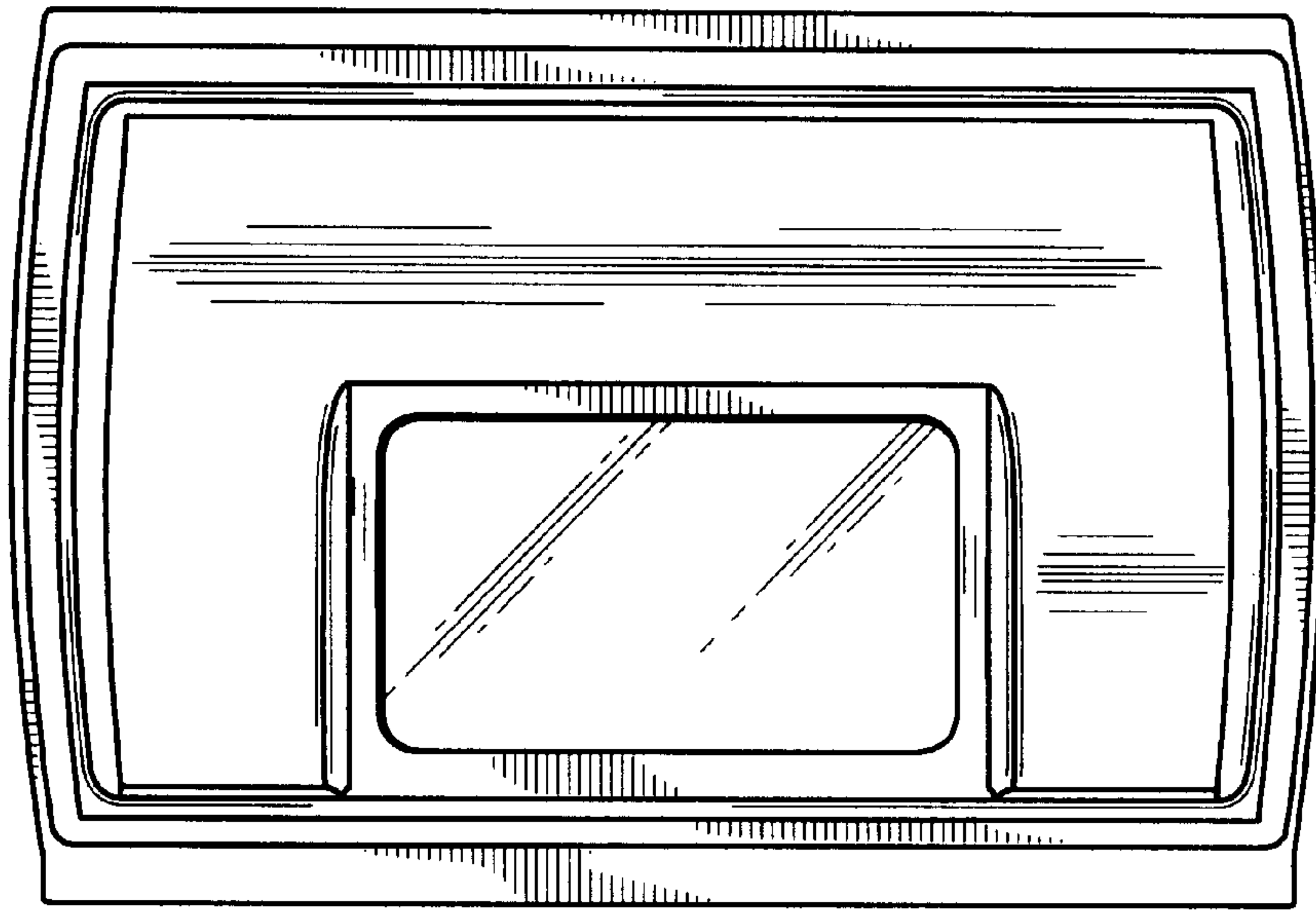




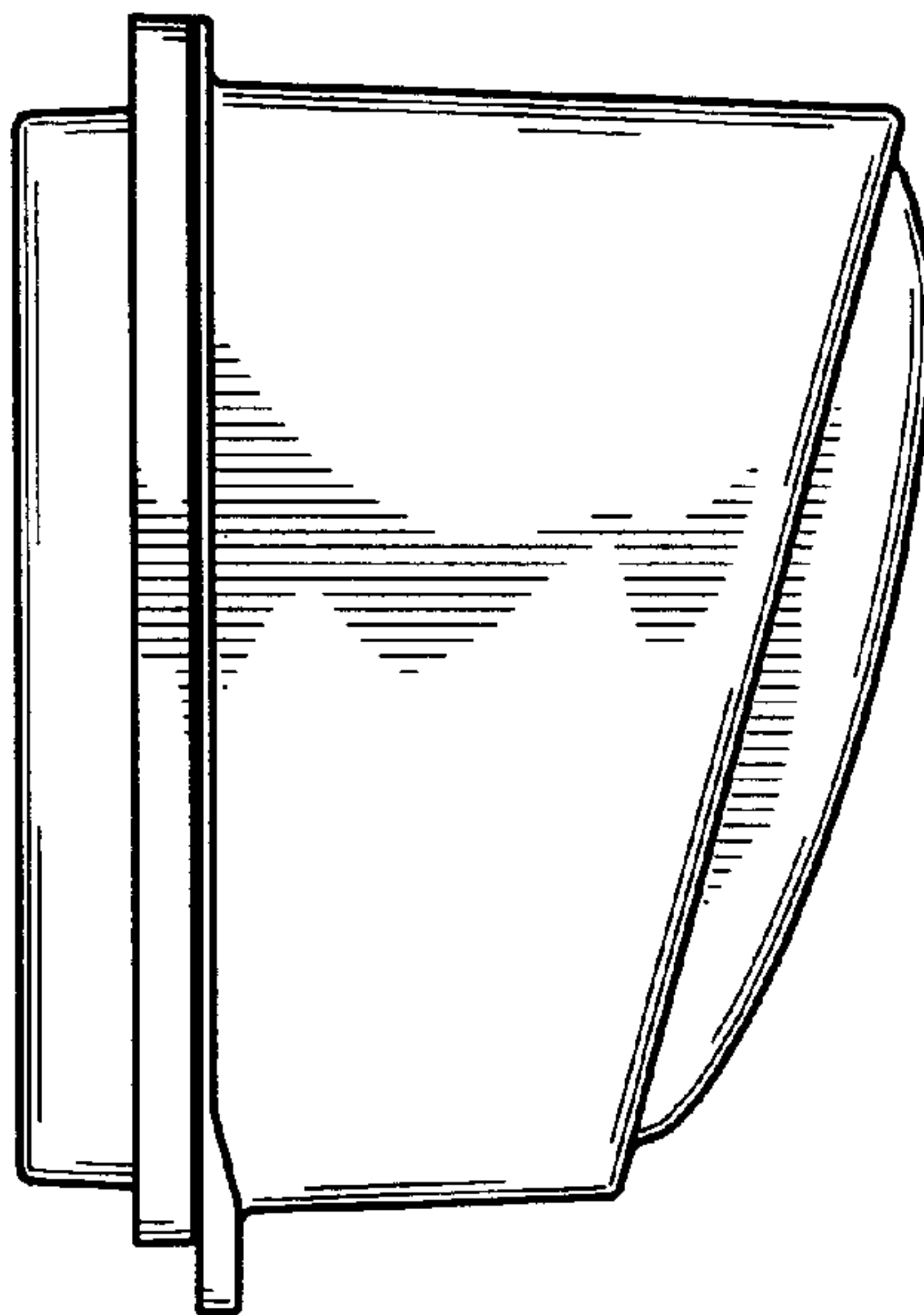
*Fig. 9*



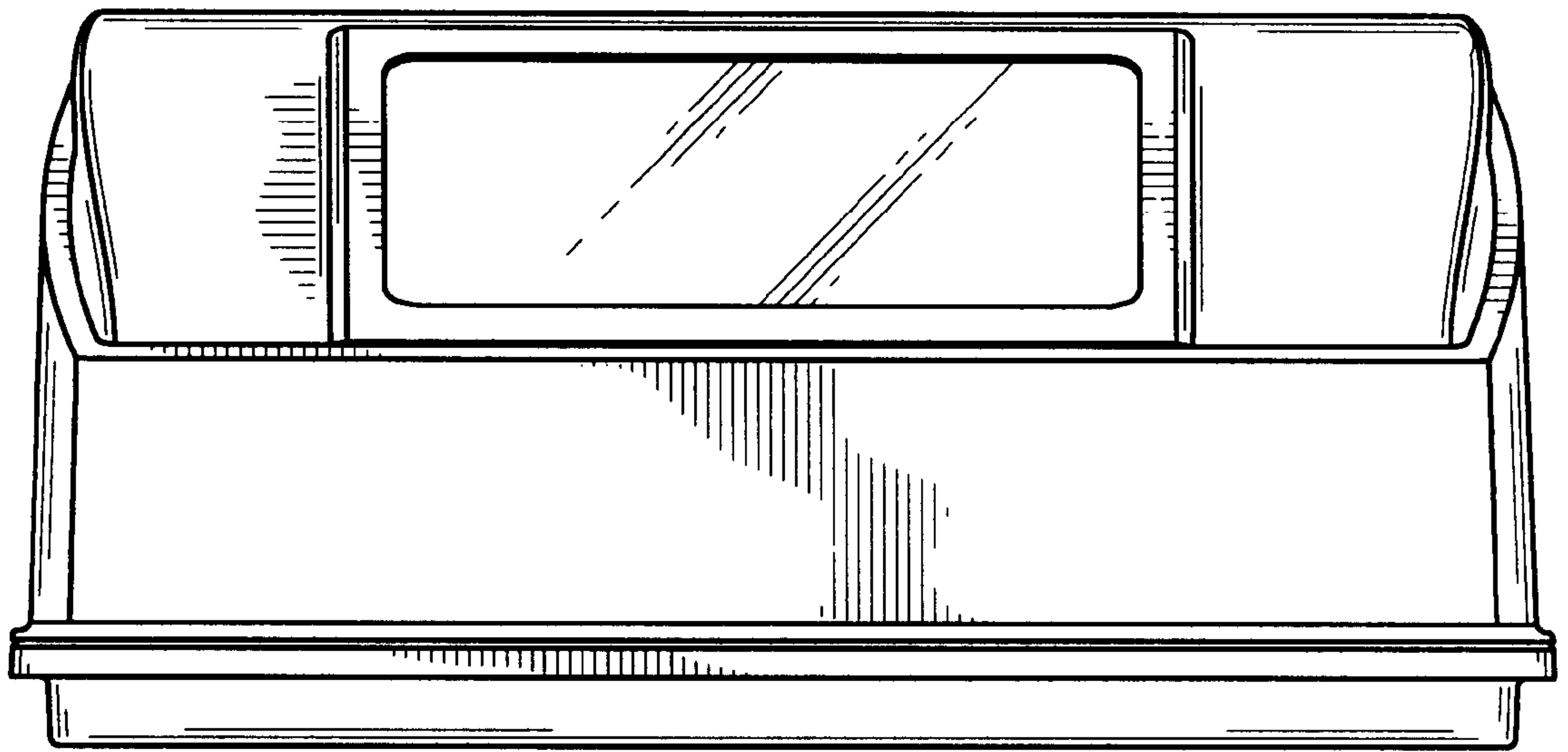
*Fig. 10*



*Fig. 11*



*Fig. 12*



*Fig. 13*