



US00D444225S

(12) **United States Design Patent**
Andersson et al.

(10) **Patent No.:** **US D444,225 S**

(45) **Date of Patent:** **** Jun. 26, 2001**

(54) **INHALER**

(75) Inventors: **Malin Andersson**, Stockholm; **Maria Benktzon**, Sollentuna; **Lennart Brunnberg**, Tyreso; **Sven-Eric Juhlin**, Stockholm, all of (SE)

(73) Assignee: **Astrazeneca AB**, Sodertalje (SE)

(**) Term: **14 Years**

(21) Appl. No.: **29/111,474**

(22) Filed: **Sep. 27, 1999**

(30) **Foreign Application Priority Data**

Mar. 26, 1999 (SE) 99-0587

(51) **LOC (7) Cl.** **29-02**

(52) **U.S. Cl.** **D24/110**

(58) **Field of Search** D24/110; 128/200.23,
128/200.14, 205.11, 203.12, 203.13, 203.15,
200.21, 200.12

(56) **References Cited**

U.S. PATENT DOCUMENTS

D. 276,847 * 12/1984 Nyman et al. D24/110

4,969,578 * 11/1990 Gander et al. 128/200.23

5,692,492 * 12/1997 Bruna et al. 128/200.23

* cited by examiner

Primary Examiner—Ian Simmons

(74) *Attorney, Agent, or Firm*—Nixon & Vanderhye

(57) **CLAIM**

The ornamental design for an “inhaler,” as shown and described.

DESCRIPTION

FIG. 1 is a front perspective view from above and to one side of an inhaler showing our new design, shown in open configuration;

FIG. 2 is a rear perspective view from above and the other side of the inhaler, shown in open configuration;

FIG. 3 is a side elevational view thereof, the opposite side elevational view being a mirror image thereto;

FIG. 4 is a front elevational view thereof;

FIG. 5 is a top plan view thereof;

FIG. 6 is a bottom plan view thereof;

FIG. 7 is a rear elevational view thereof;

FIG. 8 is a front perspective view from above and to one side of the inhaler, shown in closed configuration;

FIG. 9 is a rear perspective view from above and the other side the inhaler, shown in closed configuration;

FIG. 10 is a side elevational view thereof, the opposite side elevational view being a mirror image thereto;

FIG. 11 is a front elevational view thereof;

FIG. 12 is a top plan view thereof;

FIG. 13 is a bottom plan view thereof; and,

FIG. 14 is a rear elevational view thereof.

1 Claim, 4 Drawing Sheets

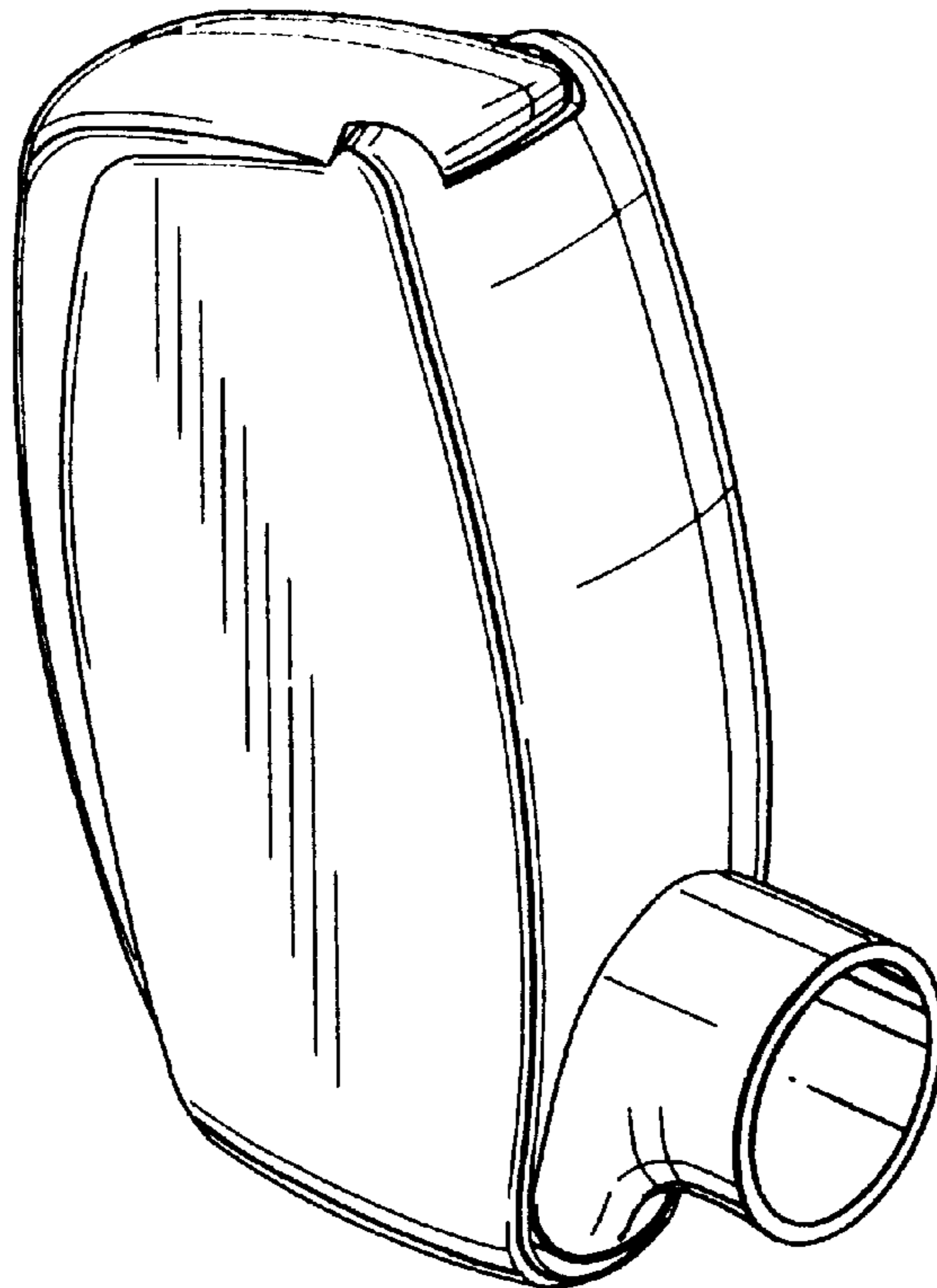

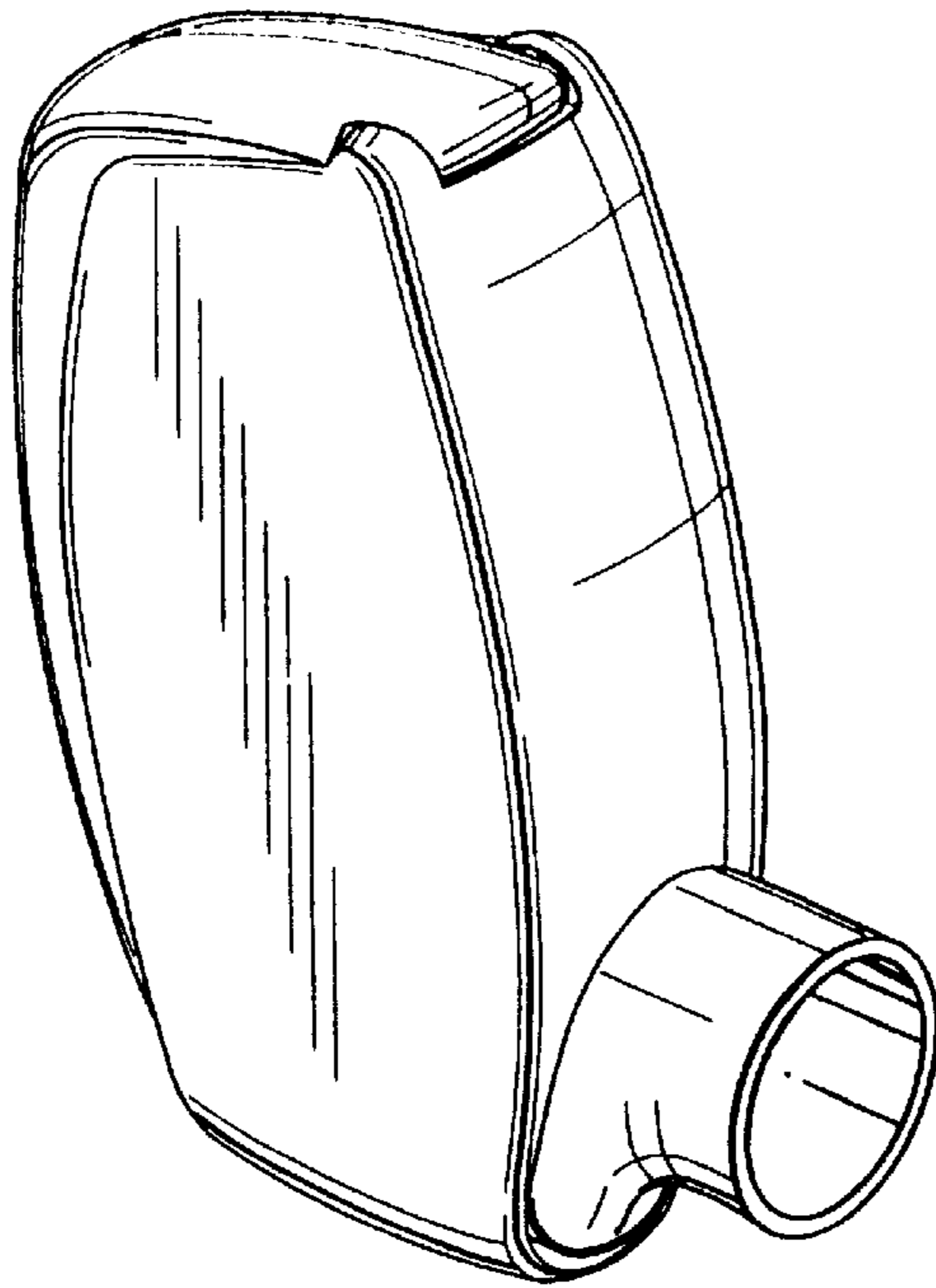

Fig. 1

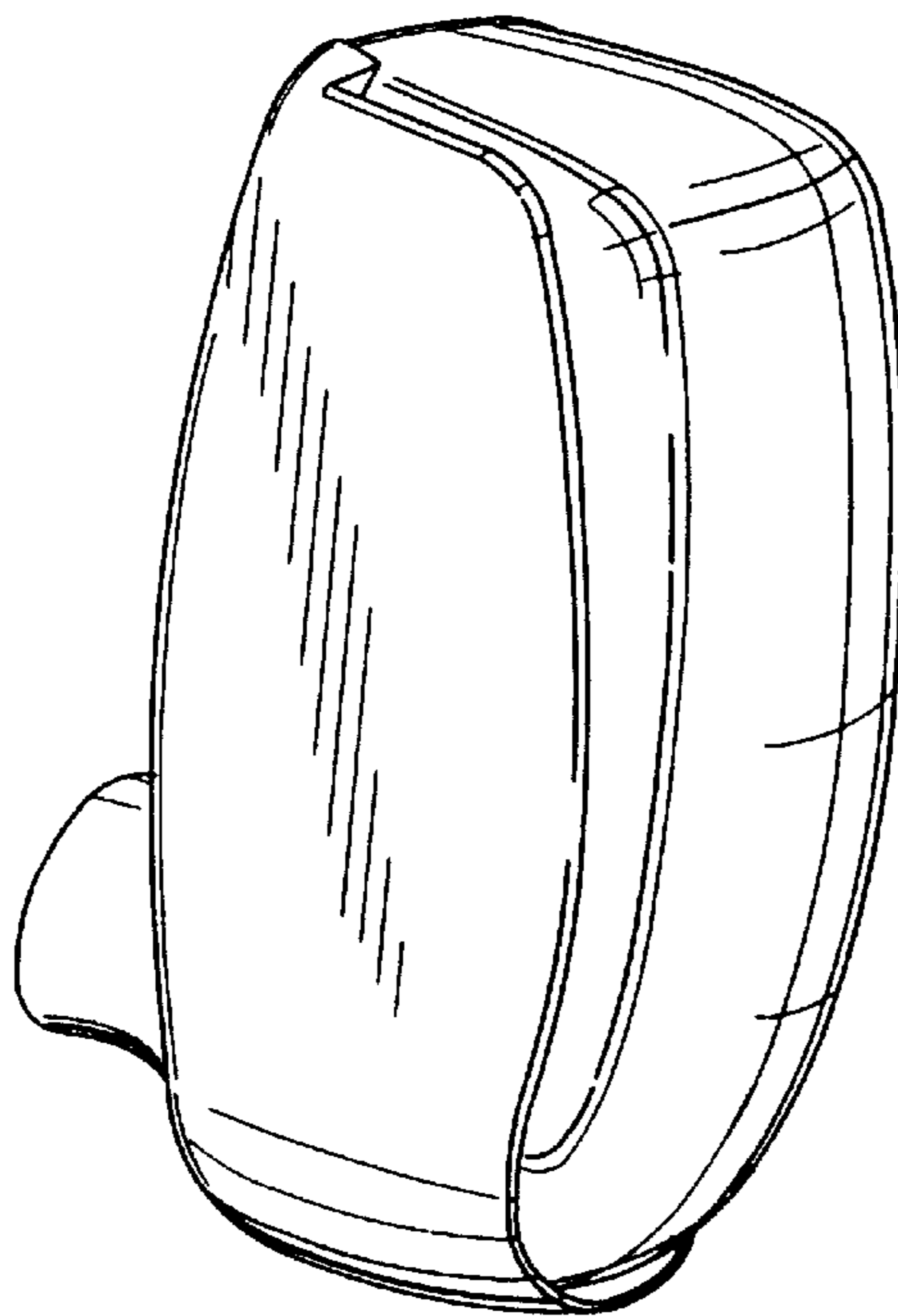

Fig. 2

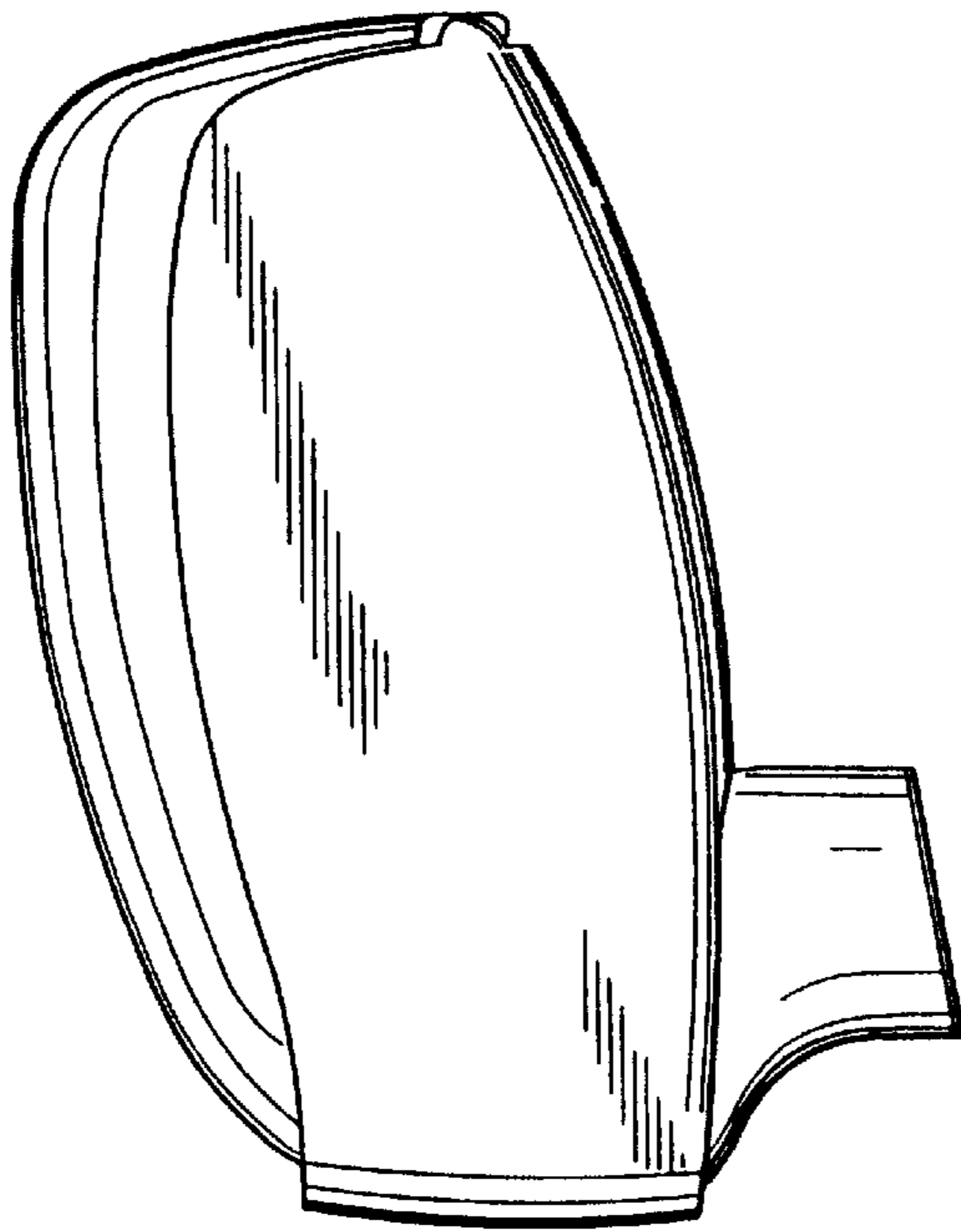

Fig. 3

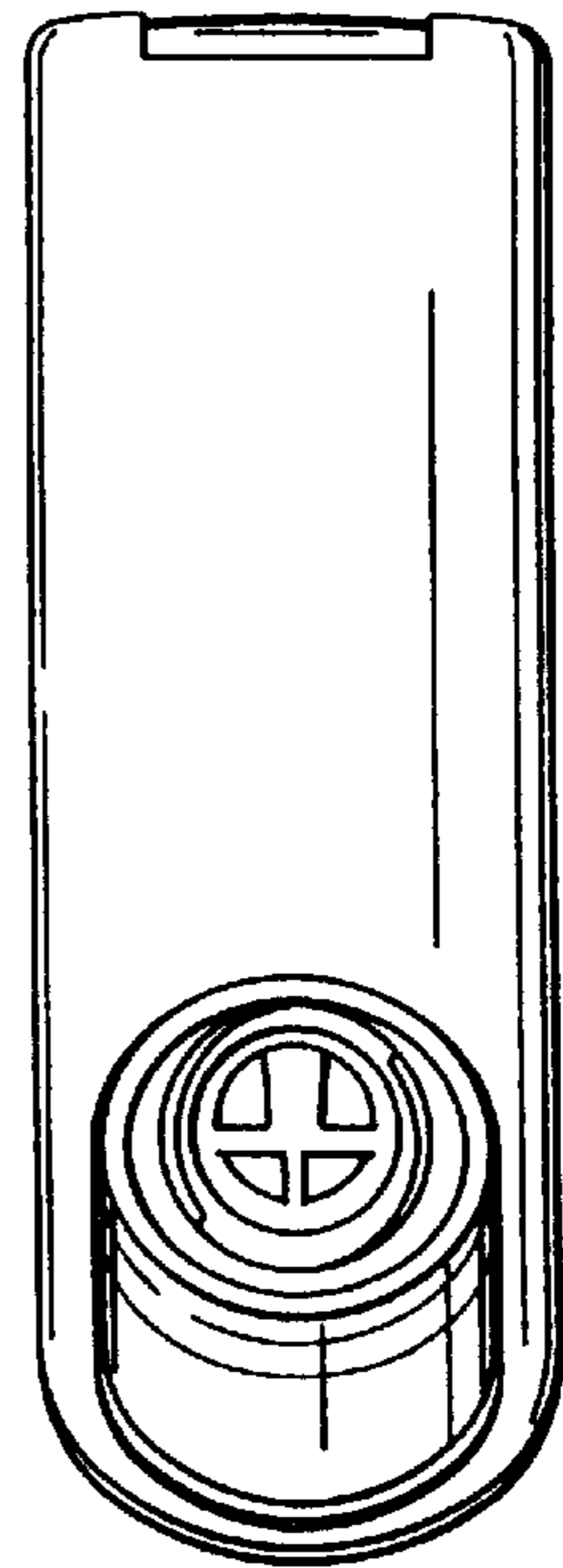

Fig. 4

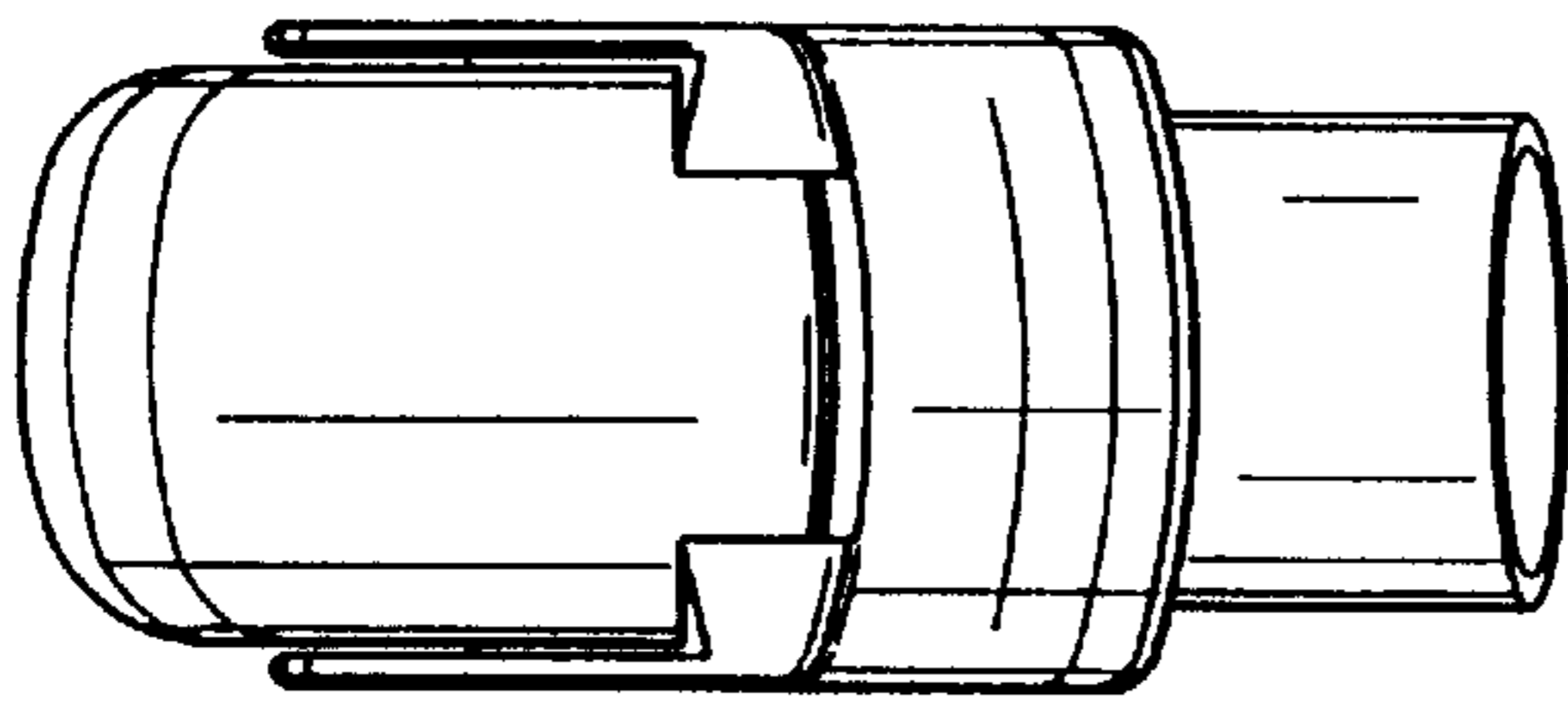

Fig. 5

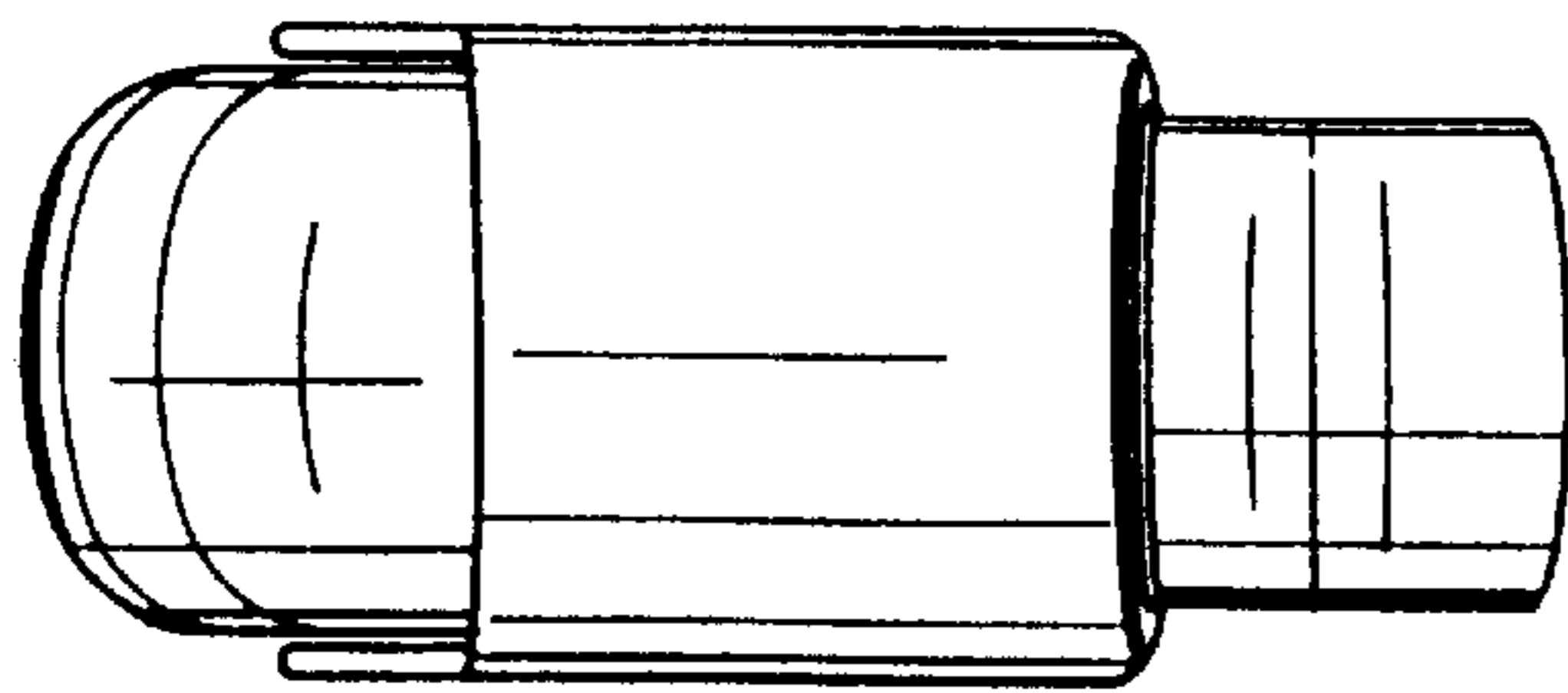

Fig. 6

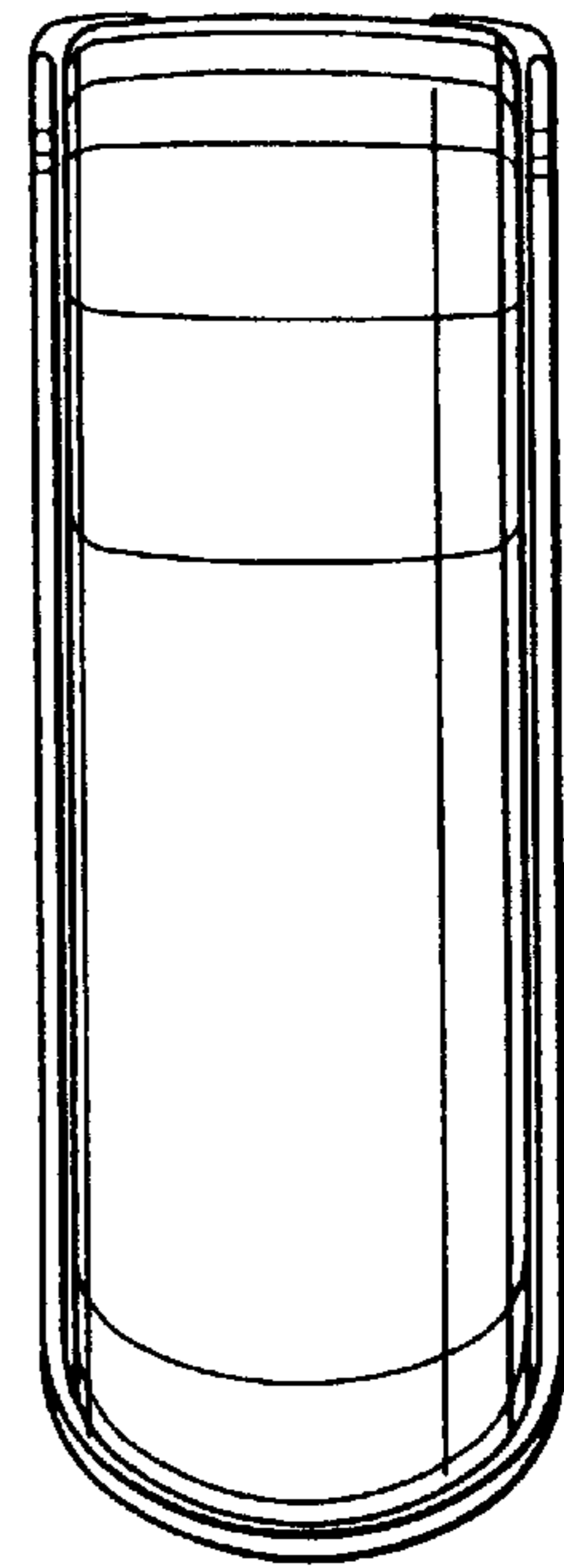

Fig. 7

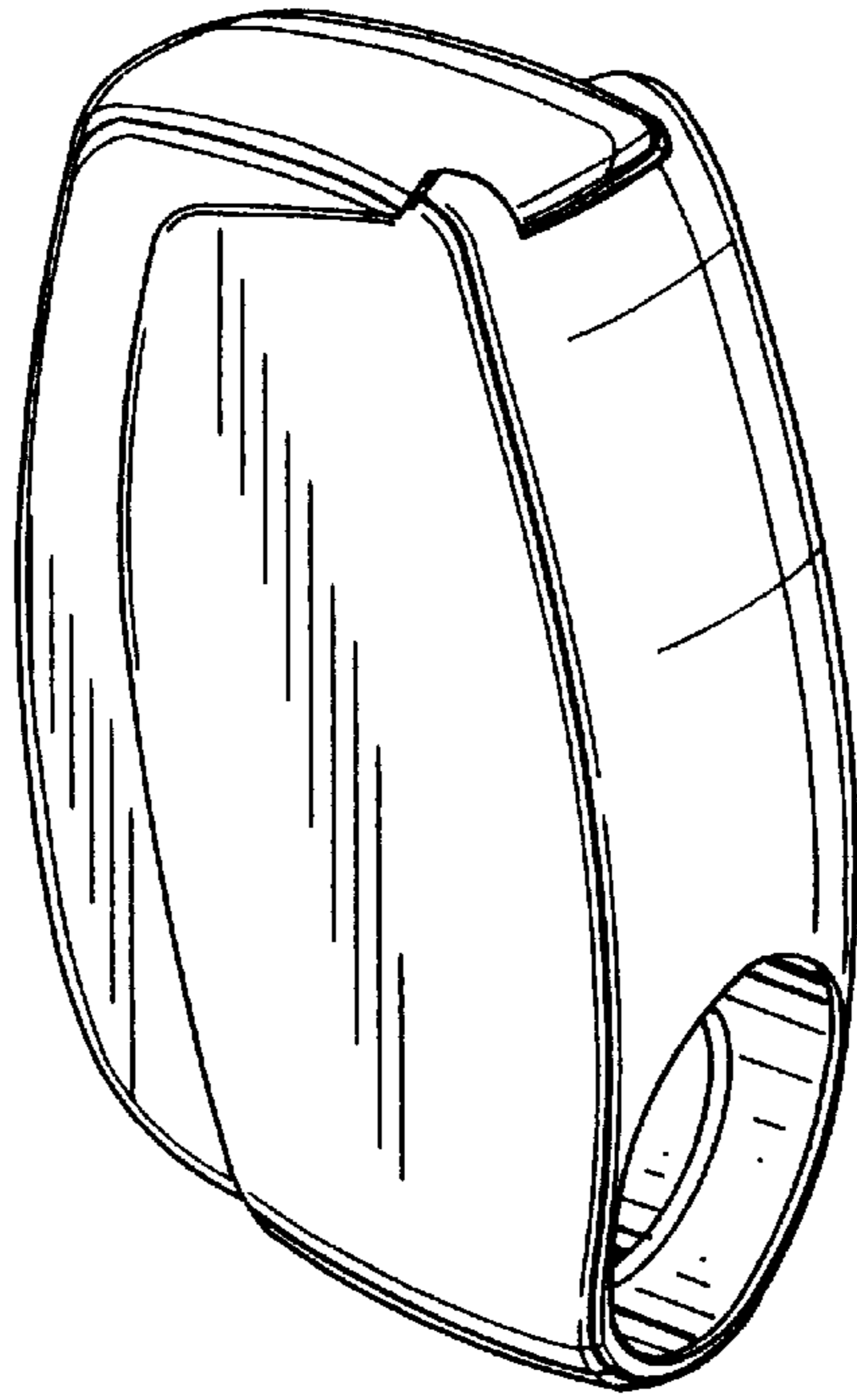

Fig. 8

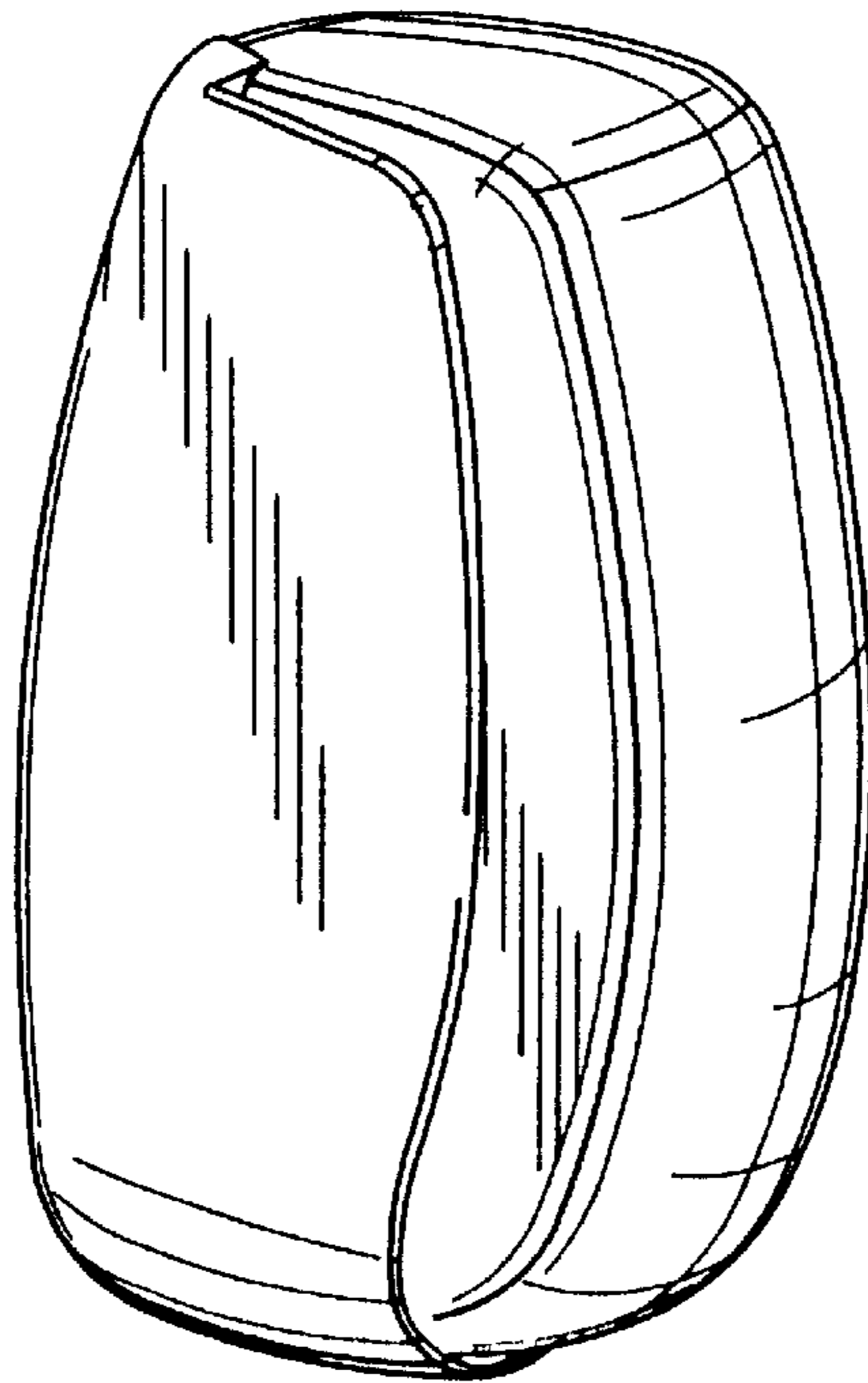

Fig. 9

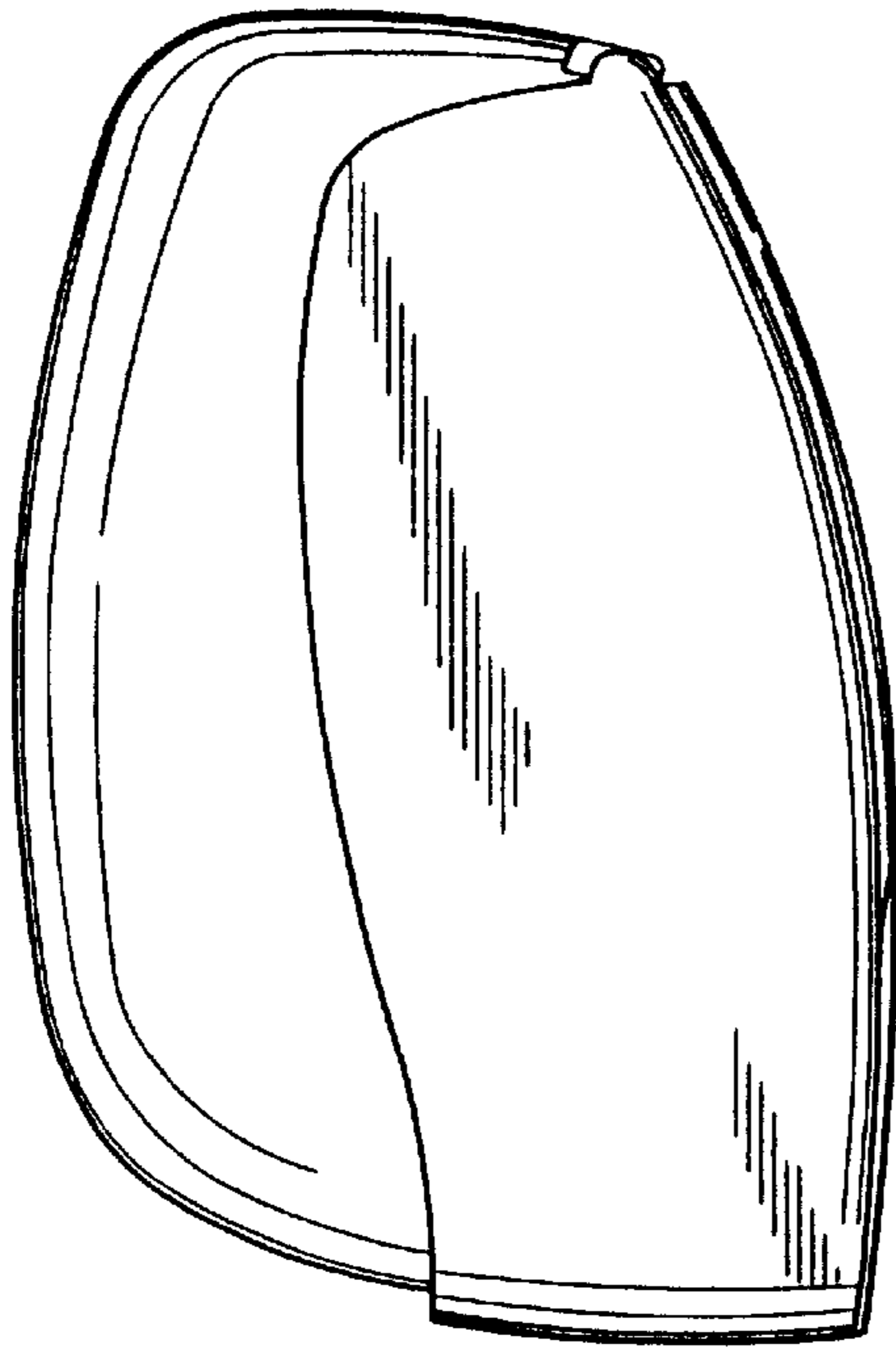

Fig. 10

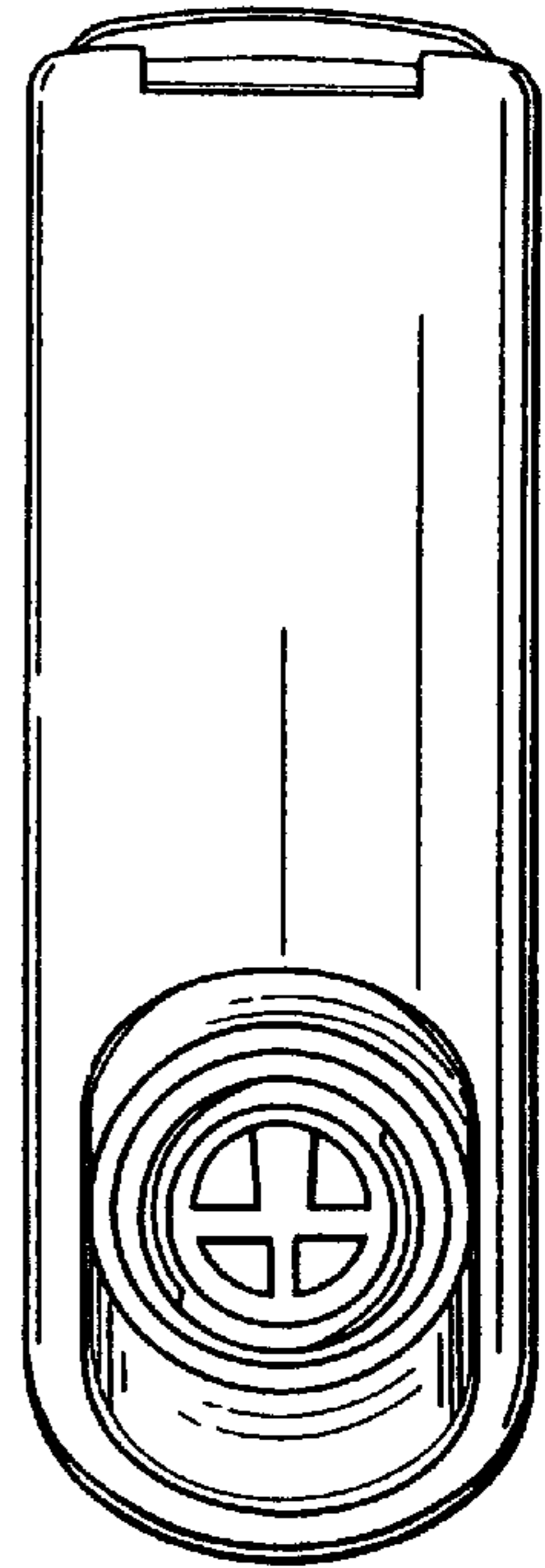

Fig. 11

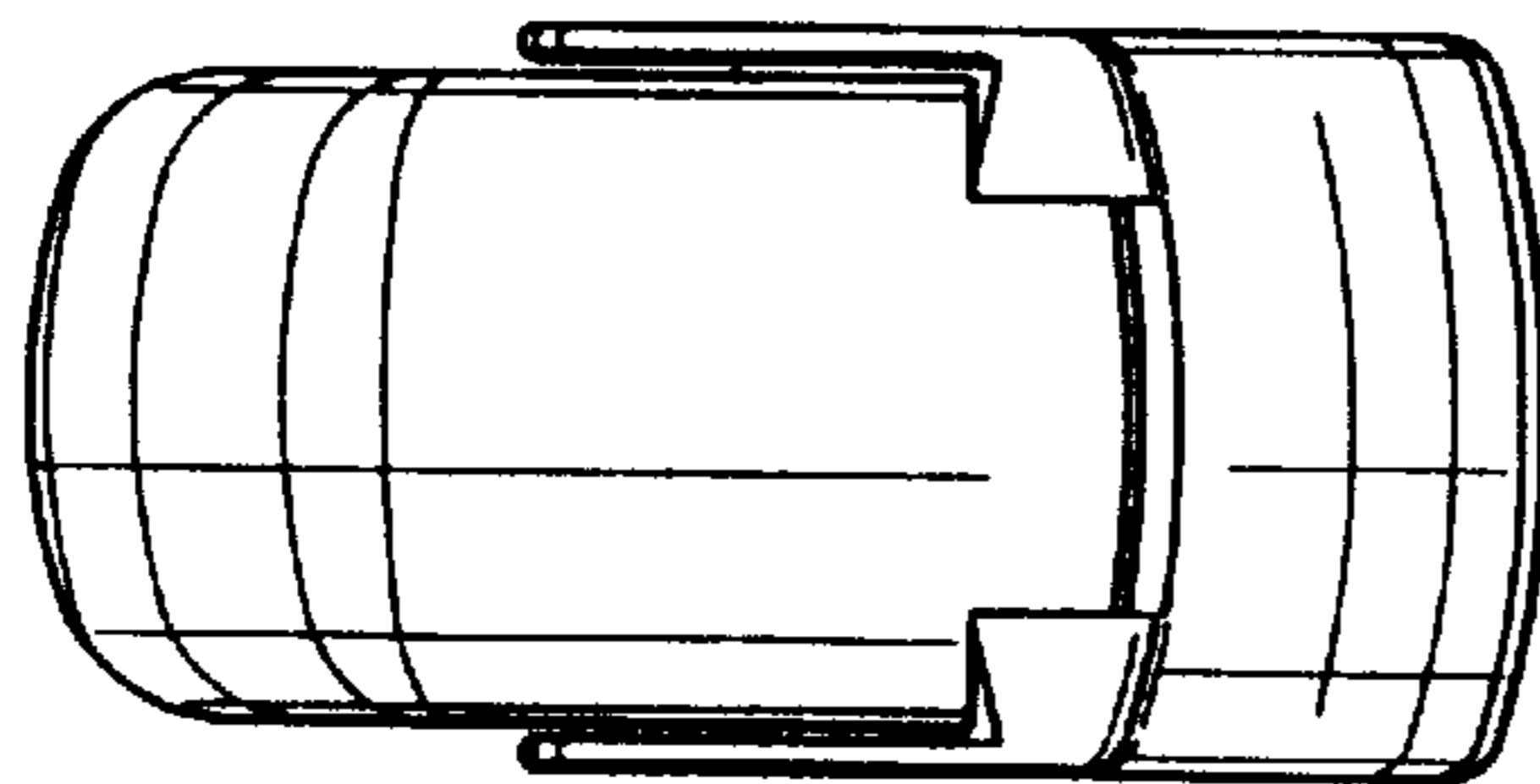

Fig. 12

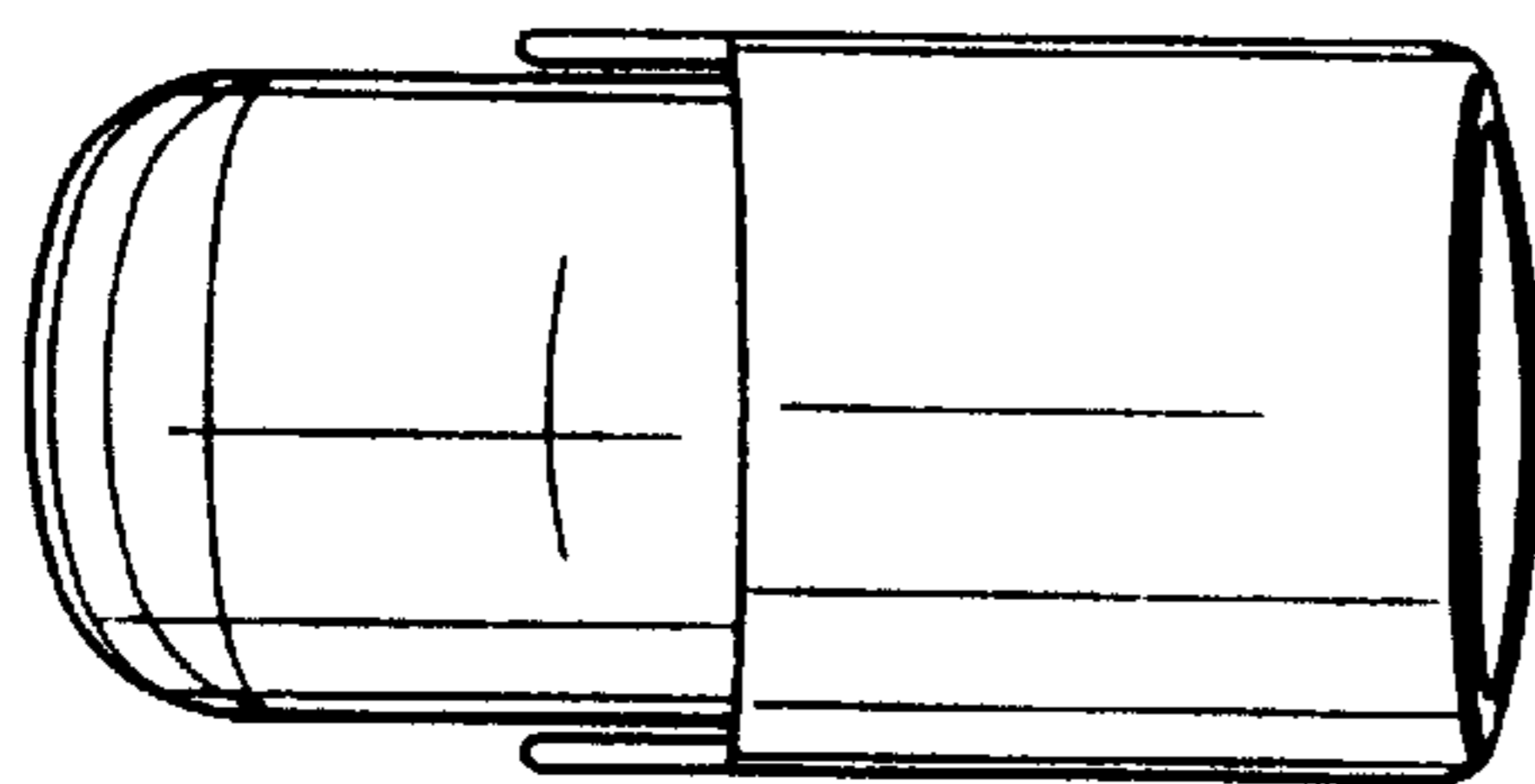

Fig. 13

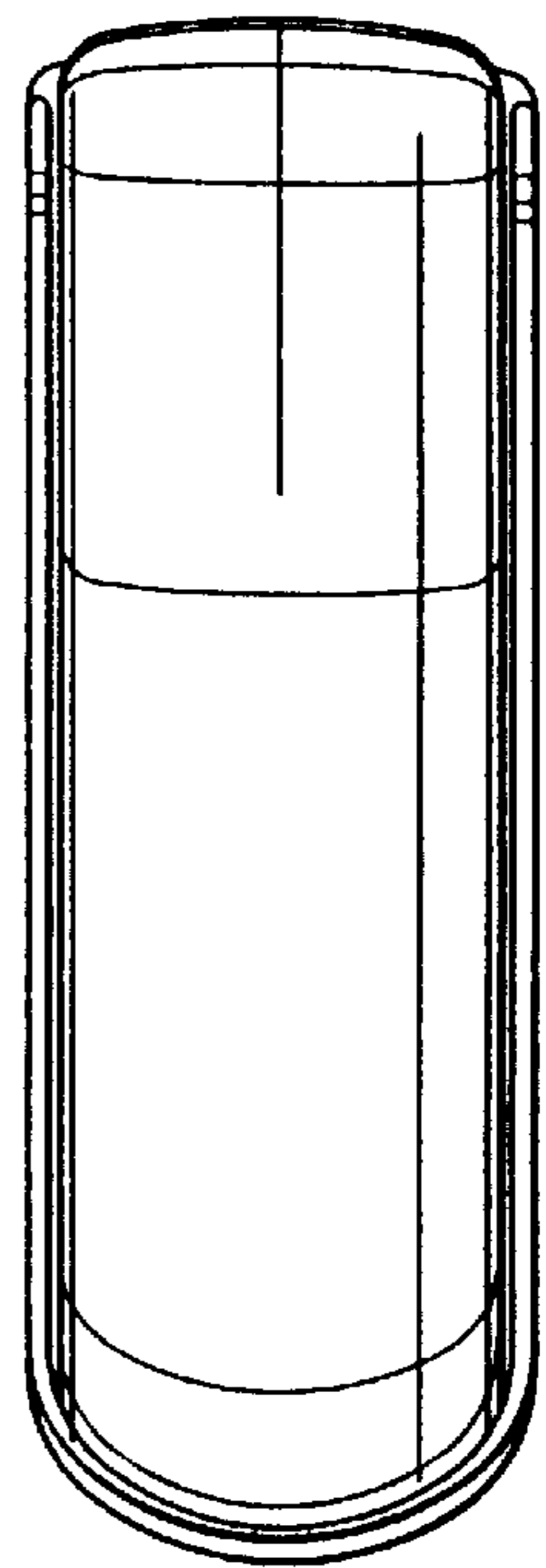

Fig. 14