



US00D444126S

(12) **United States Design Patent**  
**Chura et al.**

(10) **Patent No.:** **US D444,126 S**

(45) **Date of Patent:** **\*\* Jun. 26, 2001**

(54) **OUTLET STRIP**

(75) Inventors: **William D. Chura**, Medford, MA (US);  
**Dale Erling**, Pleasant Grove, UT (US);  
**Bryan R. Hotaling**, Arlington, MA (US)

(73) Assignee: **Curtis Computer Products, Inc.**,  
Provo, UT (US)

(\*\*) Term: **14 Years**

(21) Appl. No.: **29/132,248**

(22) Filed: **Nov. 6, 2000**

(51) **LOC (7) Cl.** ..... **13-03**

(52) **U.S. Cl.** ..... **D13/139.8**

(58) **Field of Search** ..... D13/139.1, 139.2,  
D13/139.6-139.8; 439/501, 574, 650-653,  
638, 682; 174/67; 191/12.4; D8/359

(56) **References Cited**

**U.S. PATENT DOCUMENTS**

- D. 350,939 \* 9/1994 Rossman et al. .... D13/139.8
- D. 411,511 \* 6/1999 Rossman et al. .... D13/139.6
- 6,004,157 \* 12/1999 Glass ..... 439/574

\* cited by examiner

*Primary Examiner*—Susan J. Lucas

*Assistant Examiner*—Jennifer Rivard

(74) *Attorney, Agent, or Firm*—Pennie & Edmonds LLP

(57) **CLAIM**

The ornamental design for an outlet strip, as shown and described.

**DESCRIPTION**

FIG. 1 is a top, front, left perspective view of an outlet strip having a cable manager along left and right sides thereof according to the present invention, with the power button and cord being shown in broken lines and thus not constituting a part of the claimed design;

FIG. 2 is a front elevational view thereof;

FIG. 3 is a rear elevational view thereof;

FIG. 4 is a left side elevational view thereof;

FIG. 5 is a right side elevational view thereof;

FIG. 6 is a top view thereof;

FIG. 7 is a top, front, left perspective view of an outlet strip having a cable manager along right and left sides thereof according to the present invention, with the outlets, power button, and telephone jacks being shown in broken lines and thus not constituting a part of the claimed design;

FIG. 8 is a front elevational view of the outlet strip of FIG. 7;

FIG. 9 is a rear elevational view of the outlet strip of FIG. 7;

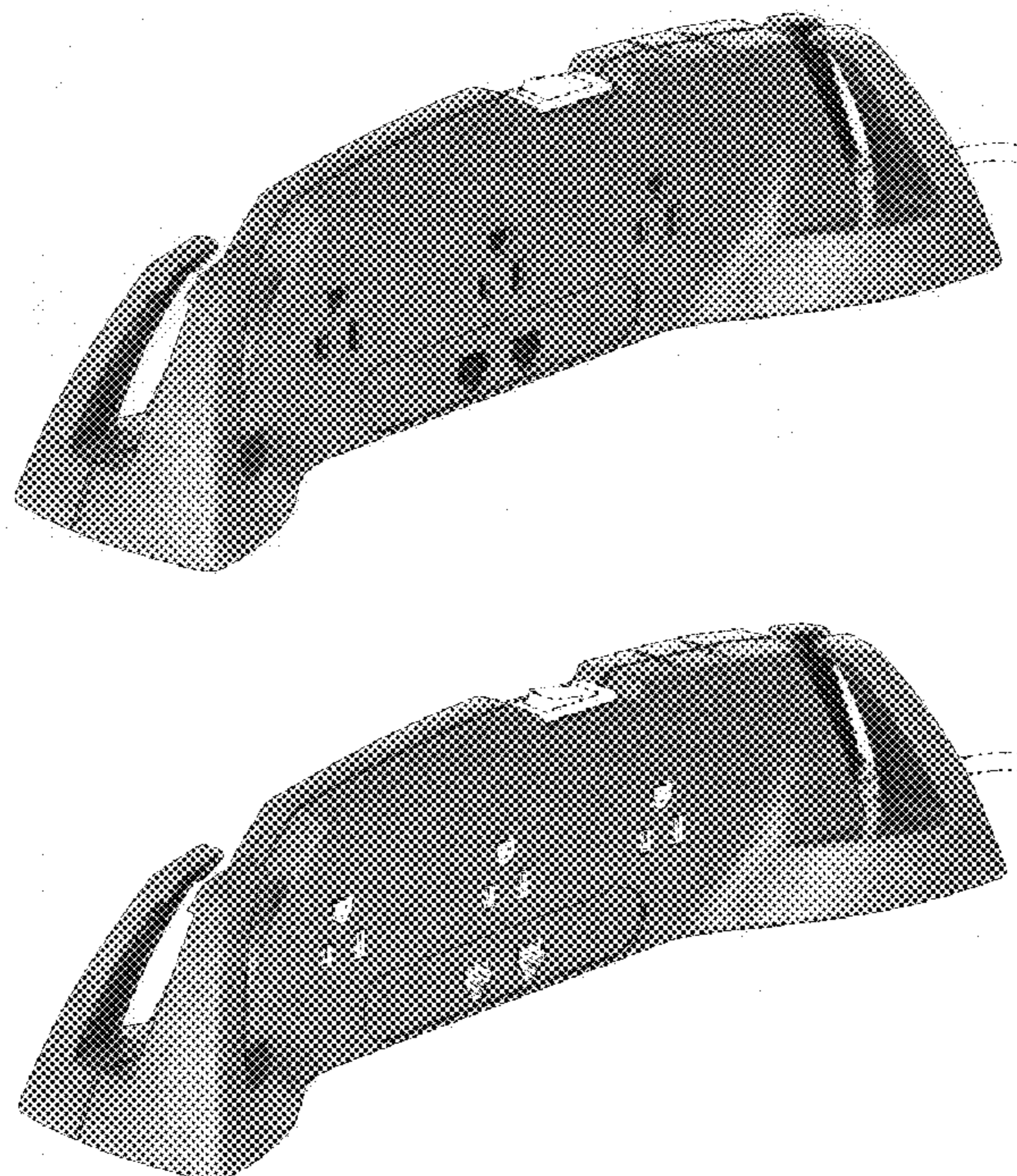
FIG. 10 is a left side elevational view of the outlet strip of FIG. 7;

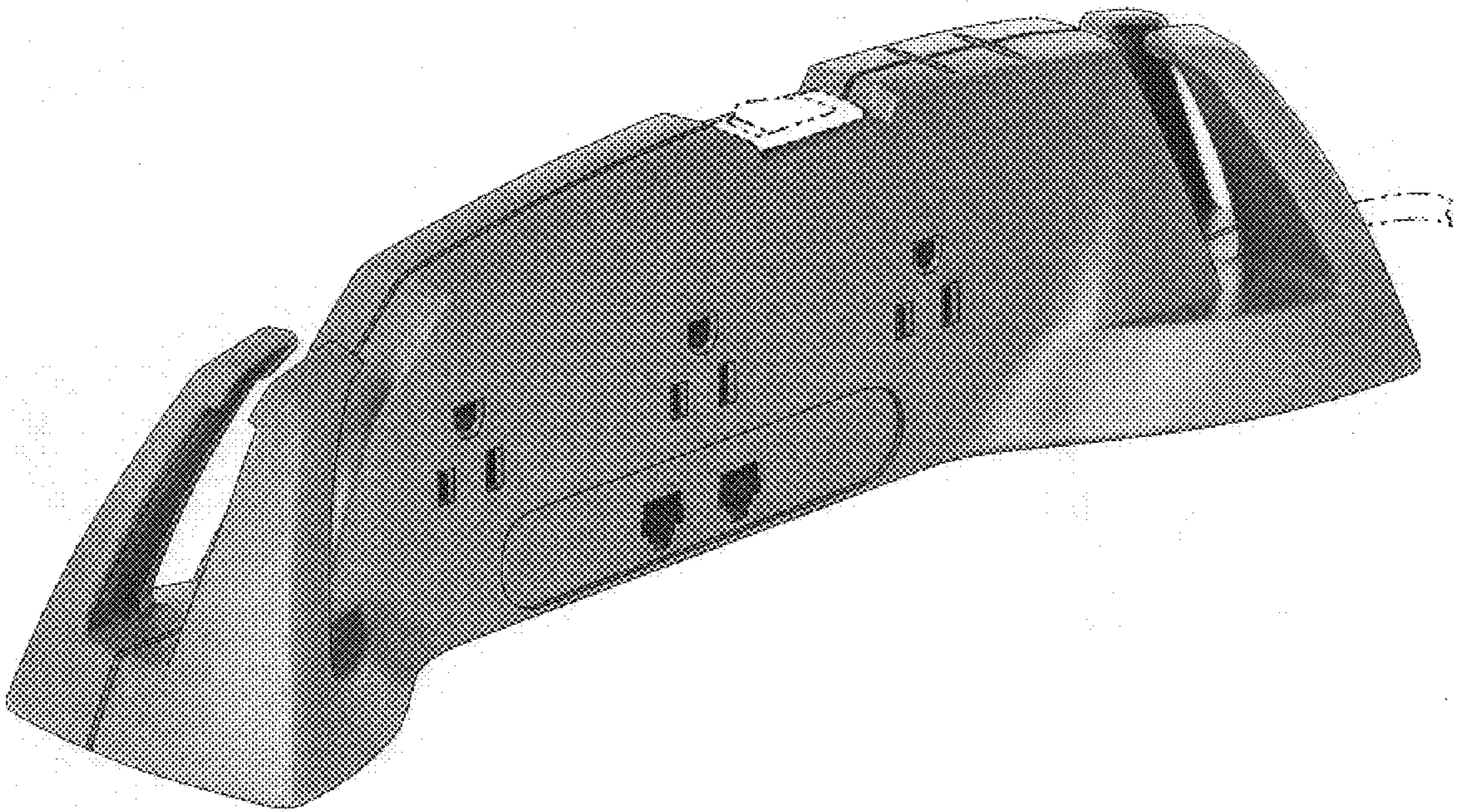
FIG. 11 is a right side elevational view of the outlet strip of FIG. 7; and,

FIG. 12 is a top view of the outlet strip of FIG. 7.

The surface(s) or portion(s) of the article not shown in the drawings or described in the specification form(s) no part of the claimed design. Features or elements shown in broken lines are shown for environmental purposes only and form no part of the claimed design.

**1 Claim, 10 Drawing Sheets**





*Fig. 1*

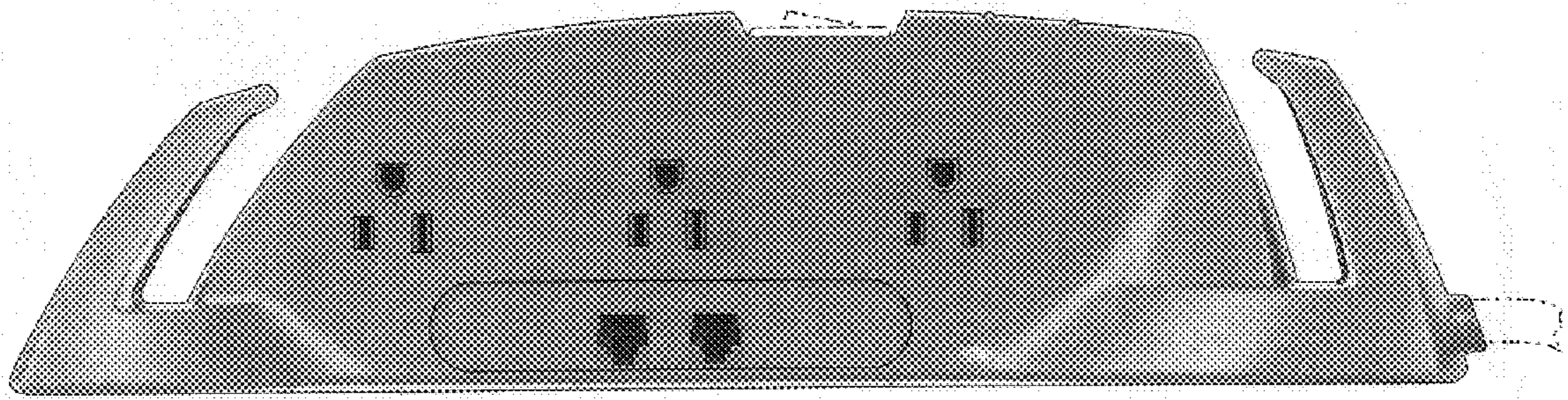
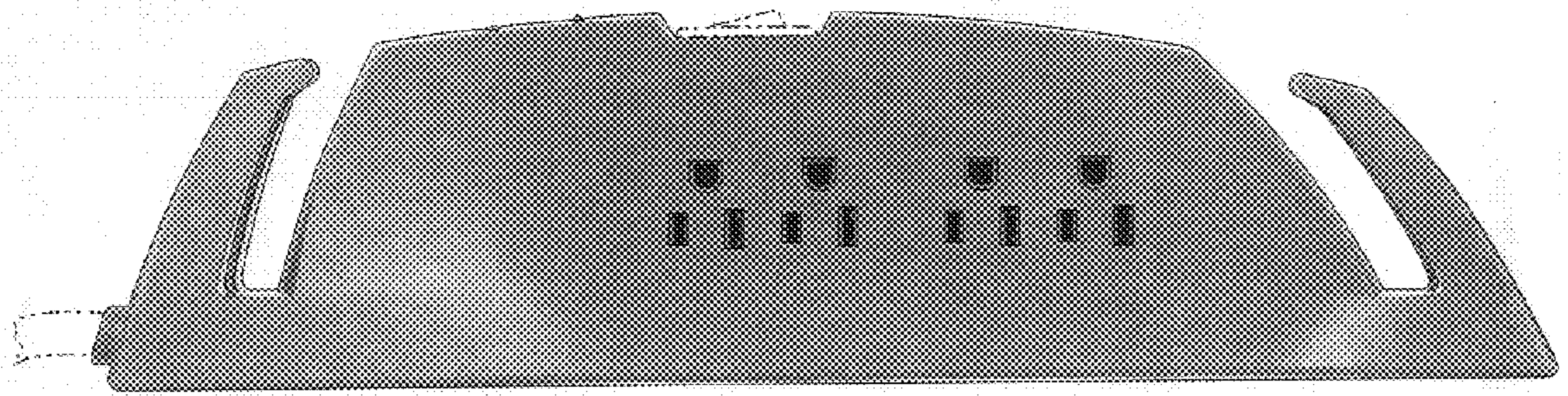
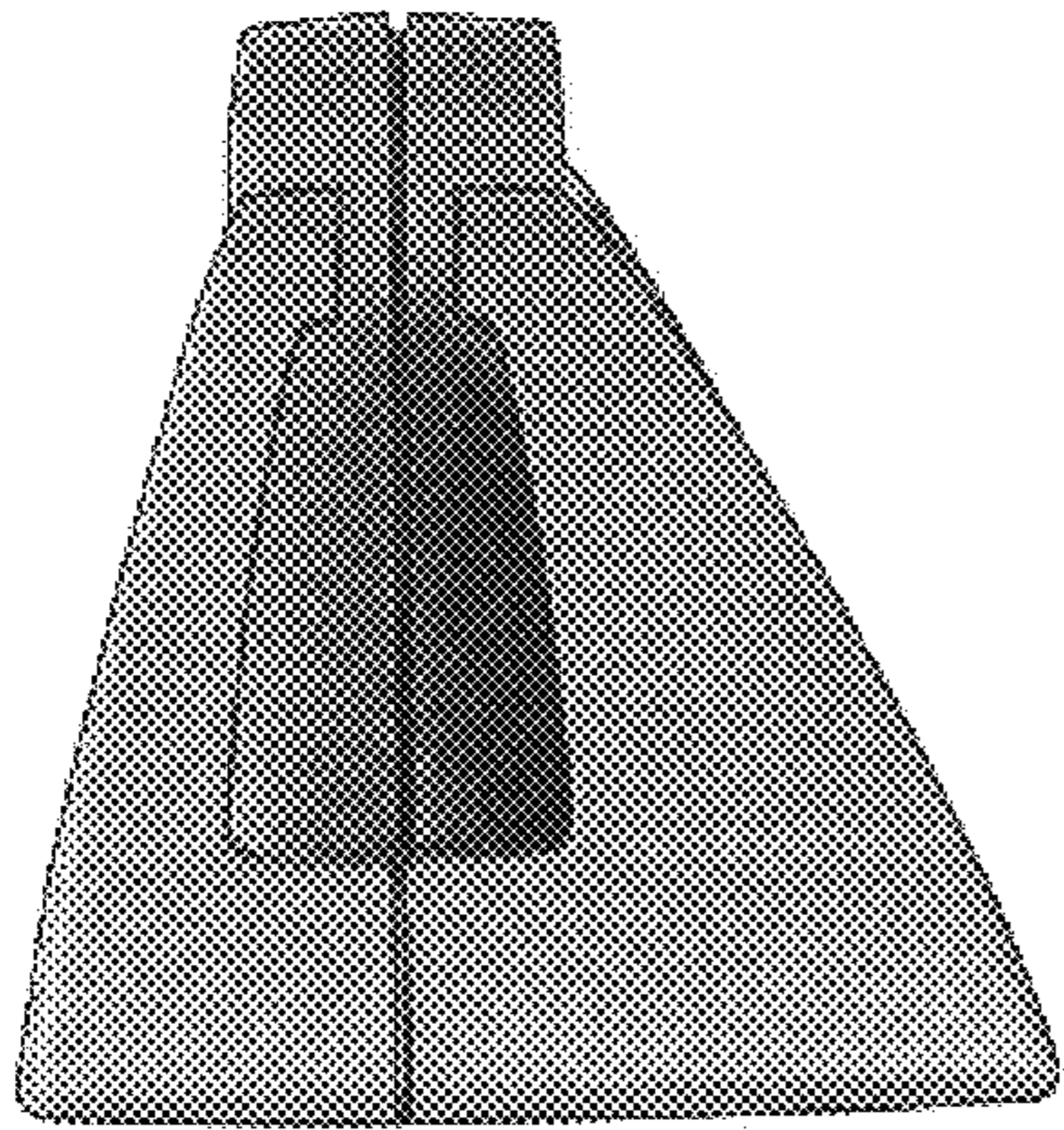


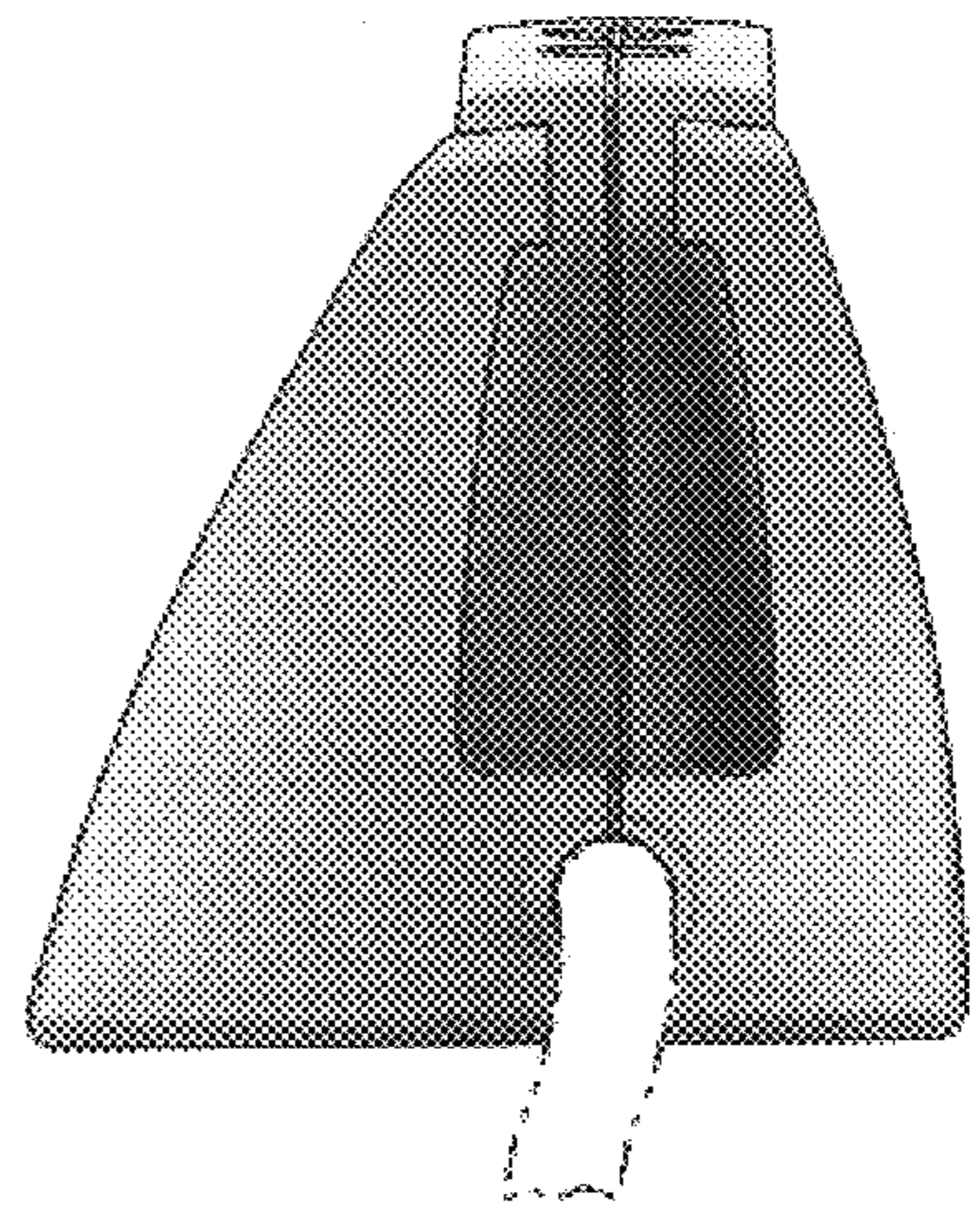
Fig. 2



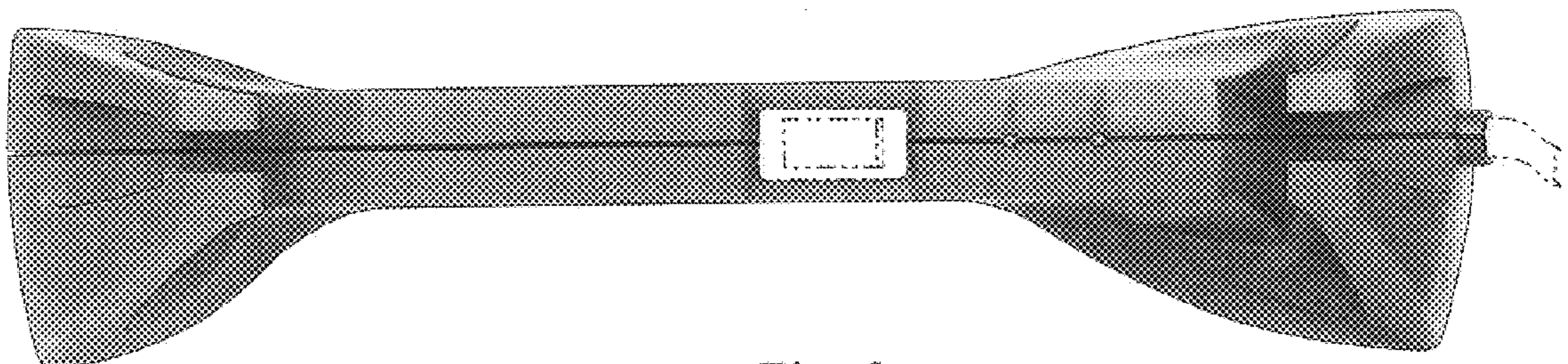
*Fig. 3*



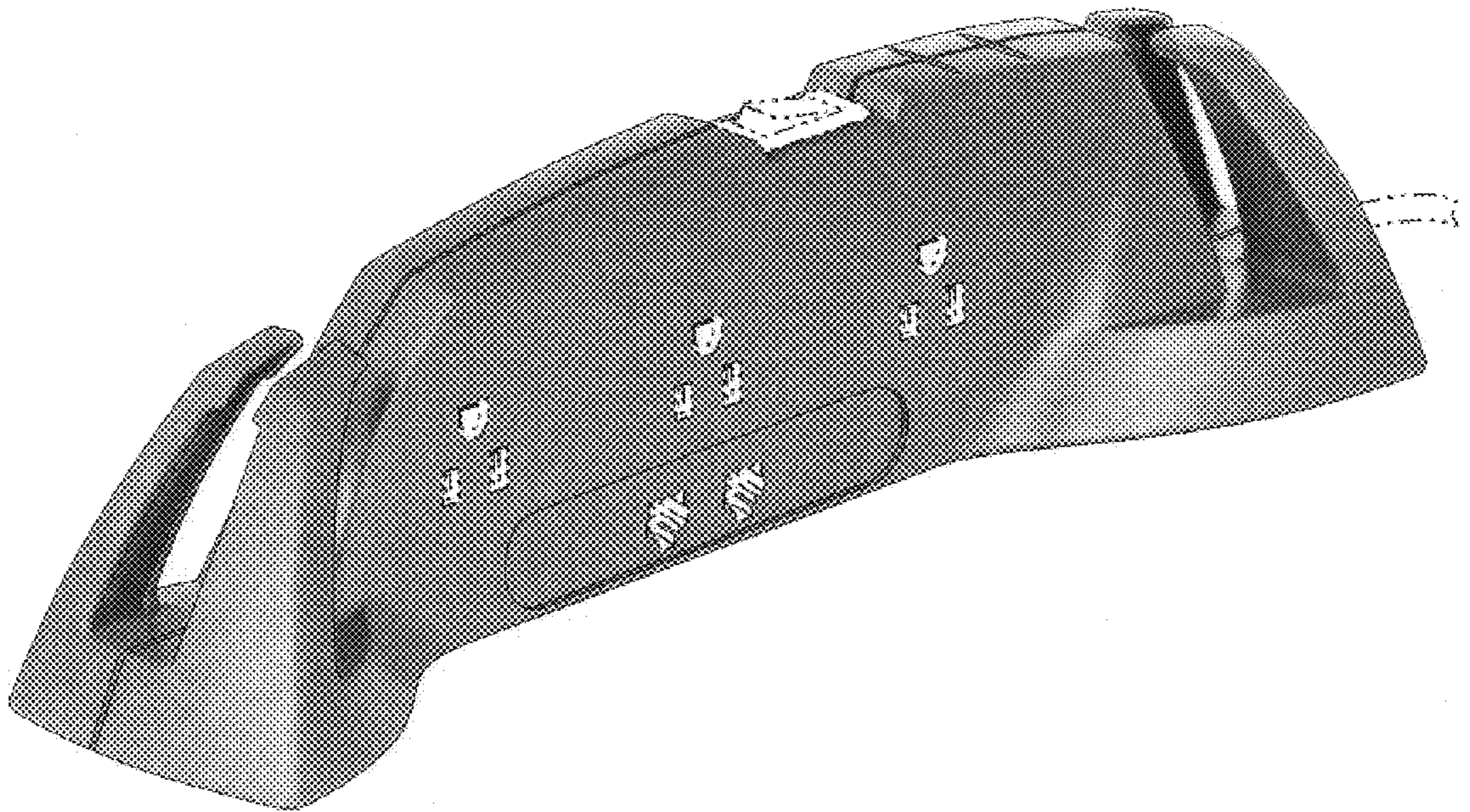
*Fig. 4*



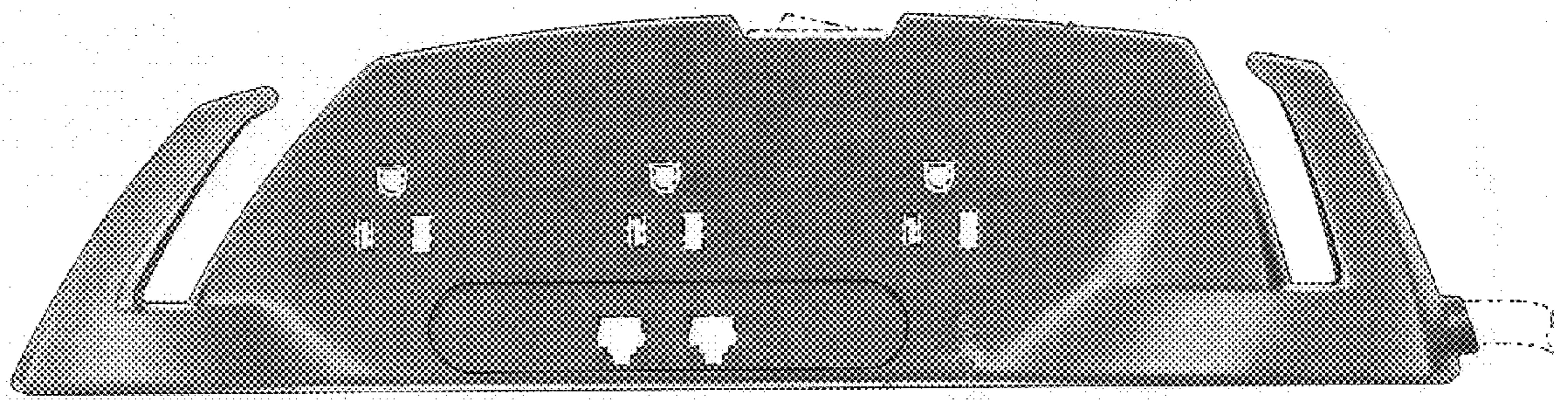
*Fig. 5*



*Fig. 6*

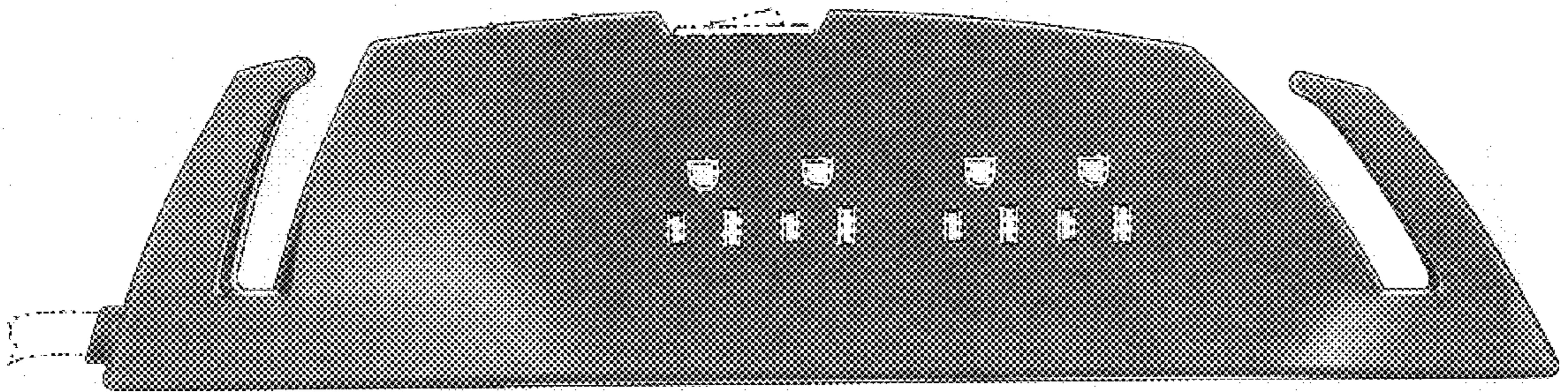


*Fig. 7*

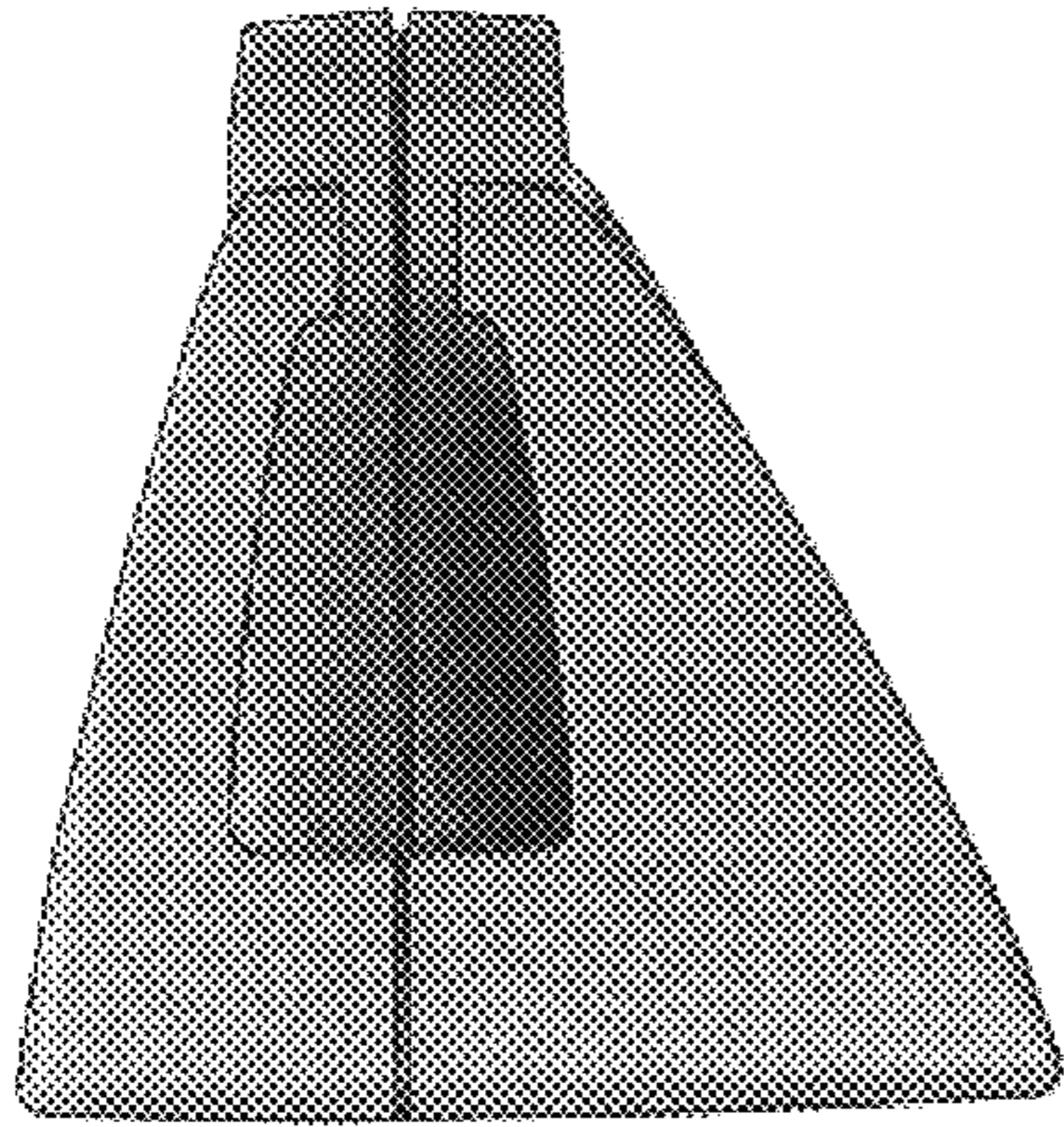


*Fig. 8*

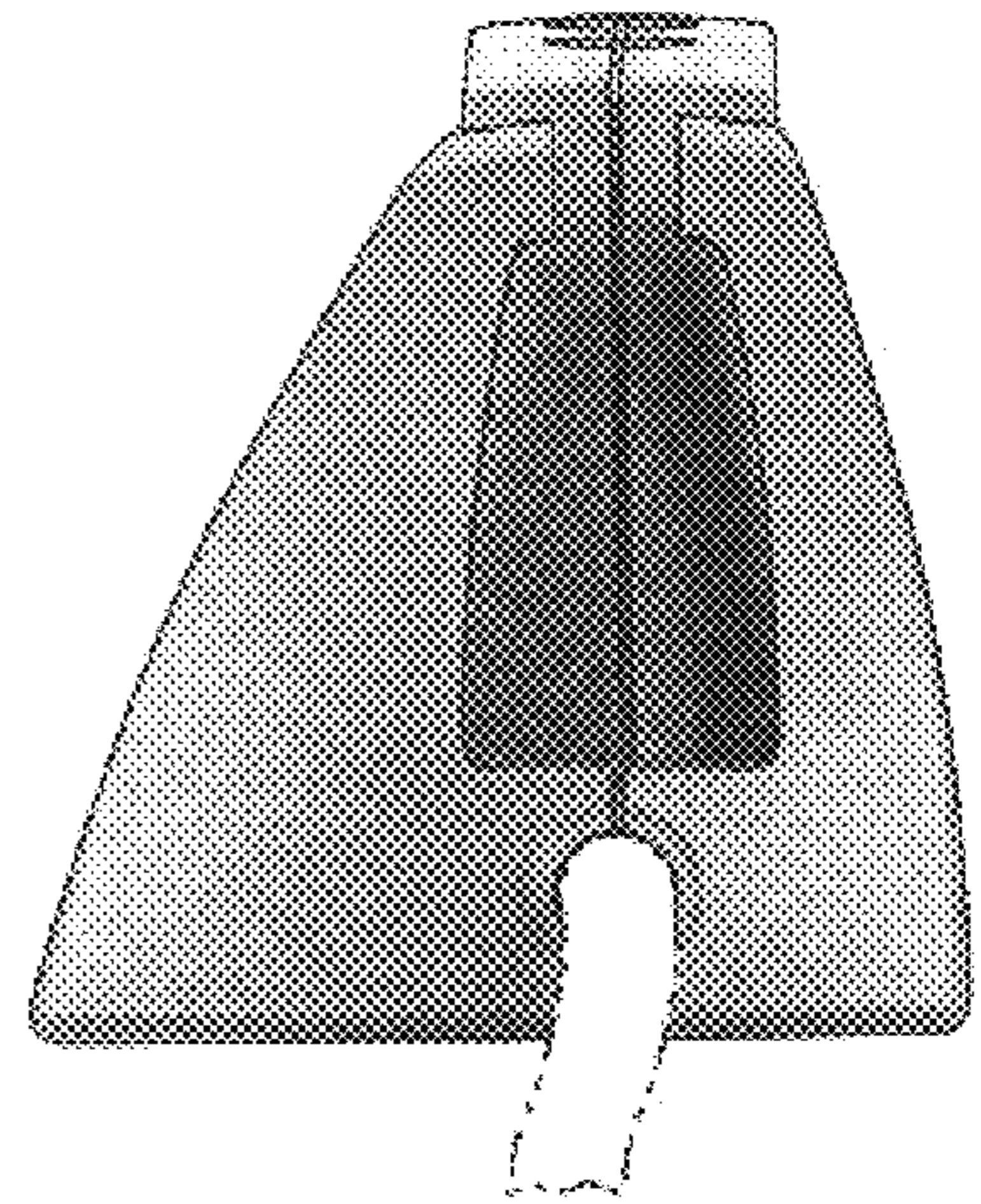




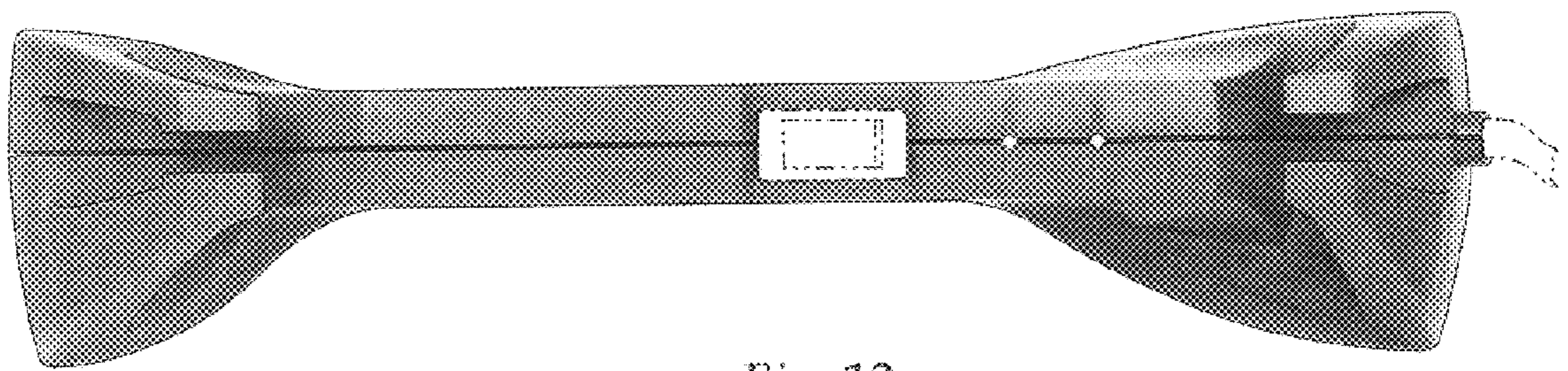
*Fig. 9*



*Fig. 10*



*Fig. 11*



*Fig. 12*