



US00D443886S

(12) **United States Design Patent**
Kabumoto et al.

(10) **Patent No.:** **US D443,886 S**

(45) **Date of Patent:** **** Jun. 19, 2001**

(54) **ELECTRONIC COPYING MACHINE**

(75) Inventors: **Masaaki Kabumoto**, Chiba; **Kazuyoshi Yamada**, Kanagawa; **Yoshihisa Minakawa**, Tokyo; **Taijiroh Sueishi**; **Goroh Katsuyama**, both of Kanagawa, all of (JP)

(73) Assignee: **Ricoh Company, Ltd.**, Tokyo (JP)

(**) Term: **14 Years**

(21) Appl. No.: **29/106,450**

(22) Filed: **Jun. 17, 1999**

(30) **Foreign Application Priority Data**

Dec. 18, 1998 (JP) 10-36772

(51) **LOC (7) Cl.** **16-03**

(52) **U.S. Cl.** **D18/39**

(58) **Field of Search** D18/36-39; 399/1-7; 358/427

(56) **References Cited**

U.S. PATENT DOCUMENTS

- D. 334,400 * 3/1993 Penke et al. D18/39
- D. 344,973 * 3/1994 Penke et al. D18/39
- D. 350,767 * 9/1994 Kojima et al. D18/38
- D. 377,944 * 2/1997 Seki et al. D18/39
- D. 425,108 * 5/2000 Kabumoto et al. D18/38

- D. 428,914 * 8/2000 Kabumoto et al. D18/39
- D. 430,596 * 9/2000 Shiozaki et al. D18/54
- D. 432,160 * 10/2000 Kabumoto et al. D18/37

* cited by examiner

Primary Examiner—Caron D. Veynar

(74) *Attorney, Agent, or Firm*—Dickstein Shapiro Morin & Oshinsky LLP

(57) **CLAIM**

The ornamental design for an electronic copying machine, as shown and described.

DESCRIPTION

FIG. 1 is a top, front and left side perspective view of an electronic copying machine showing our new design; FIG. 2 is a front elevation view thereof; FIG. 3 is a top elevation view thereof; FIG. 4 is a rear elevation view thereof; FIG. 5 is a bottom elevation view thereof; FIG. 6 is a left side elevation view thereof; FIG. 7 is right side elevation view thereof; and, FIG. 8 is a top, front and left side perspective view showing the state in which the electronic copying machine is used in combination with a sheet feeder and a stacker. The broken line showing of a sheet feeder and stacker in FIG. 8 is for illustrative purposes only and forms no part of the claimed design.

1 Claim, 5 Drawing Sheets

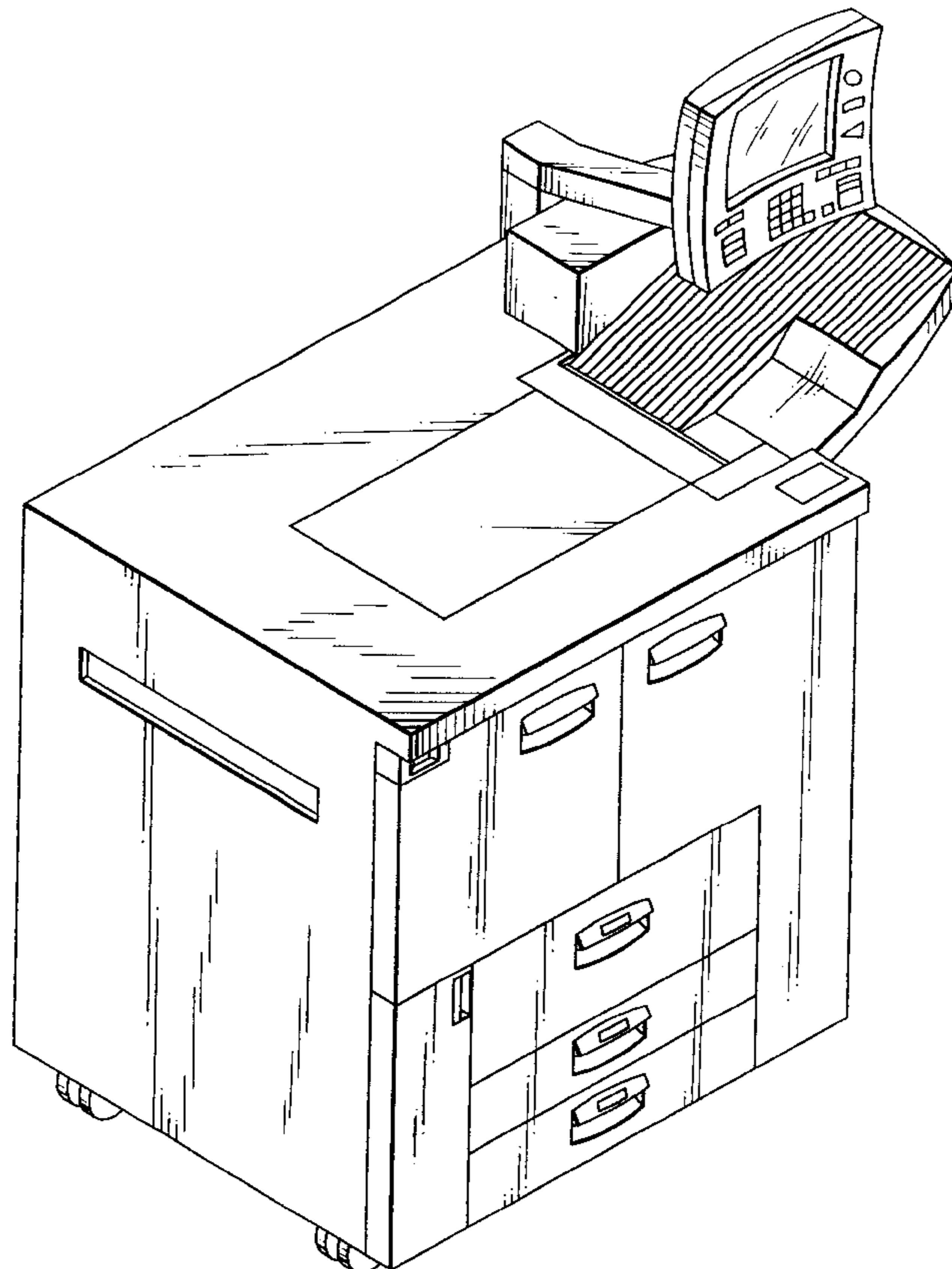

FIG. 1

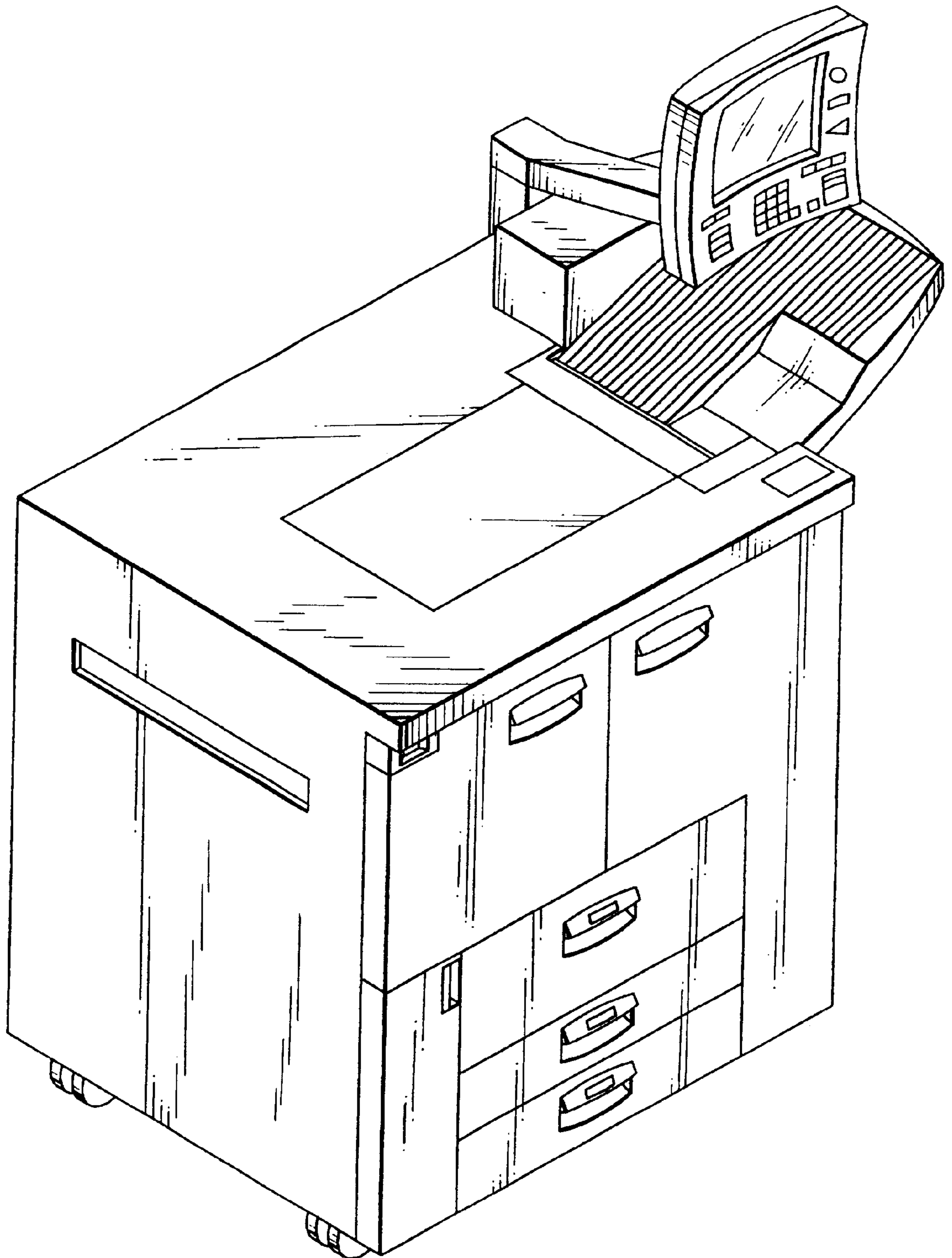

FIG. 2

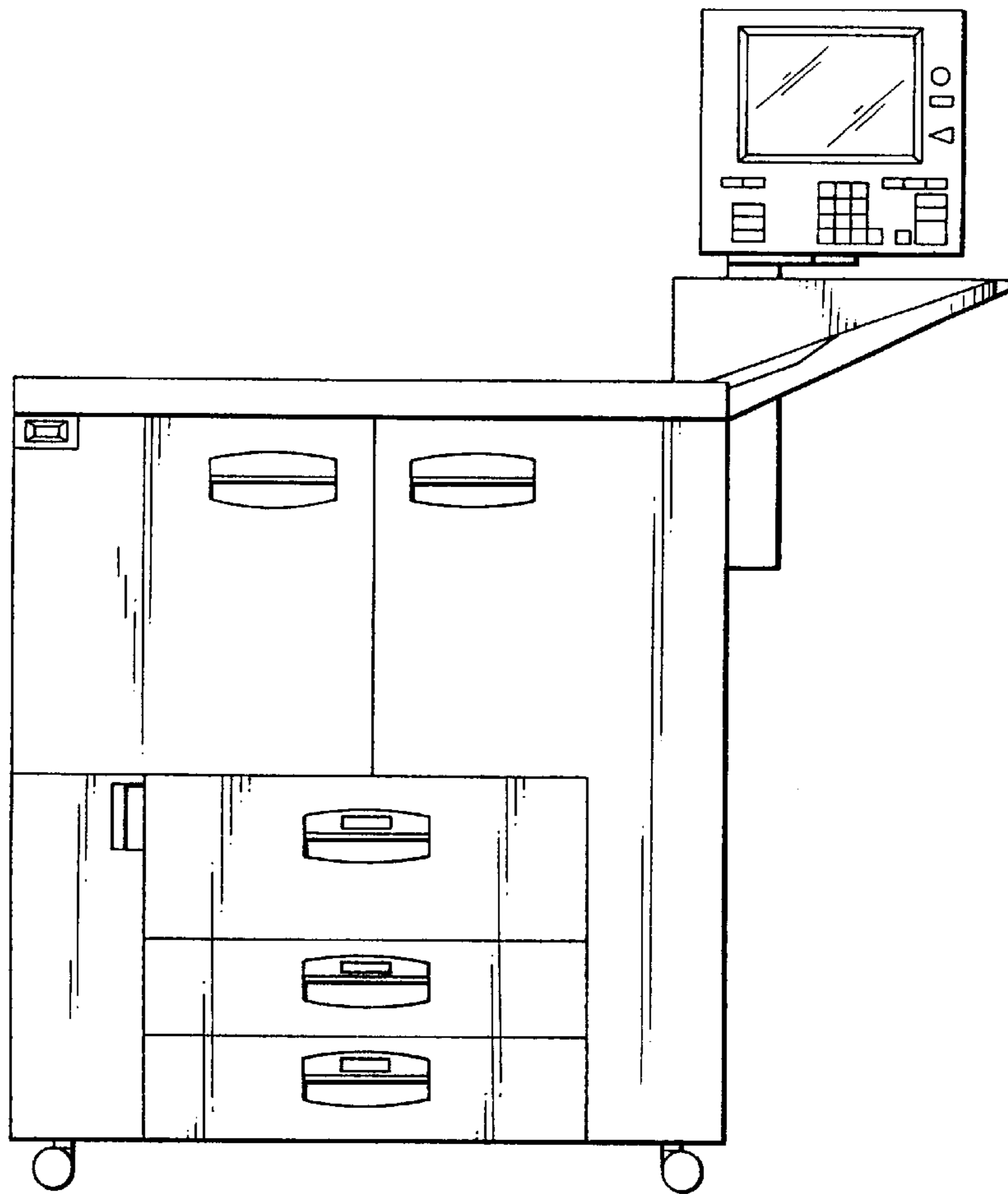

FIG. 3

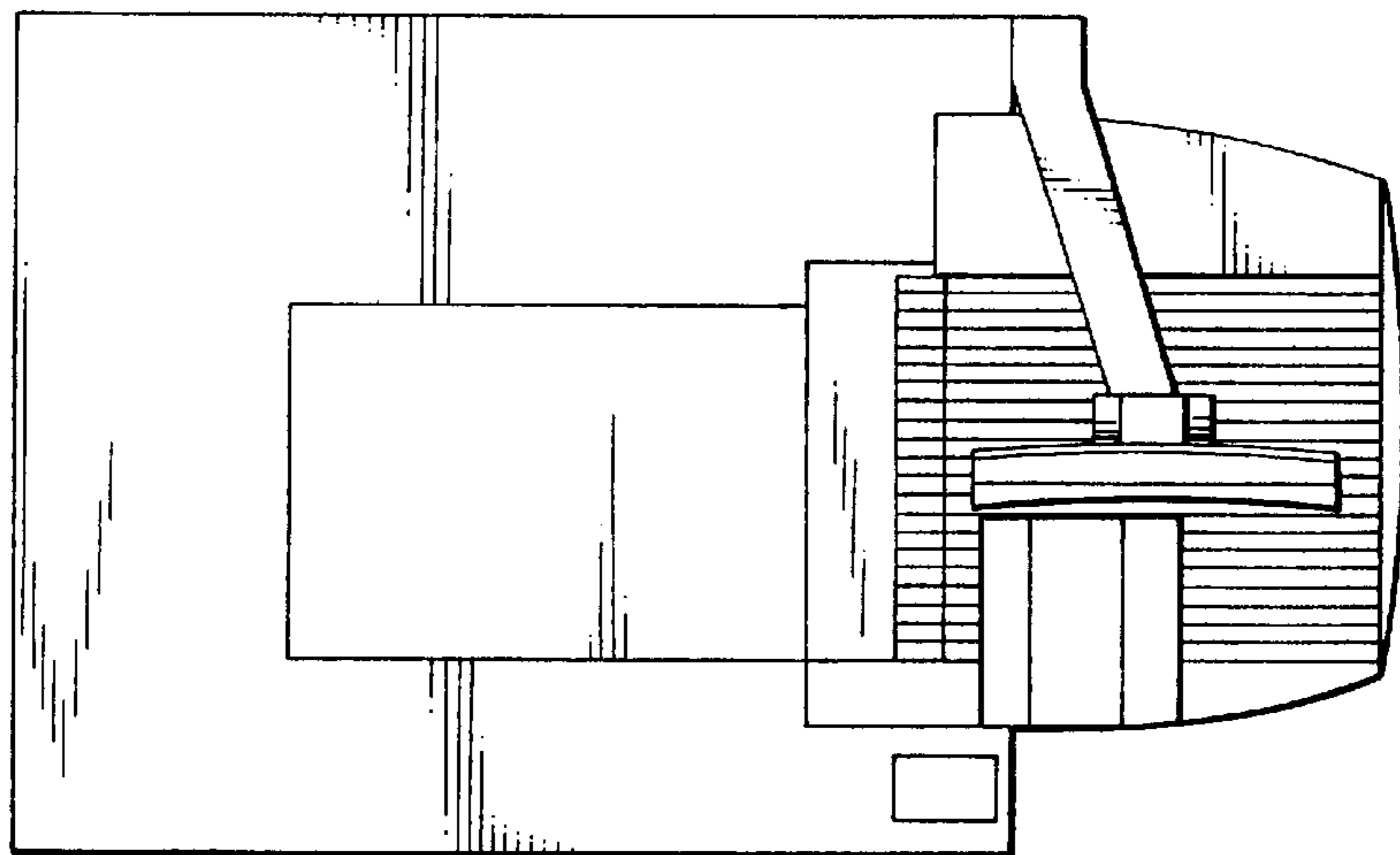

FIG. 4

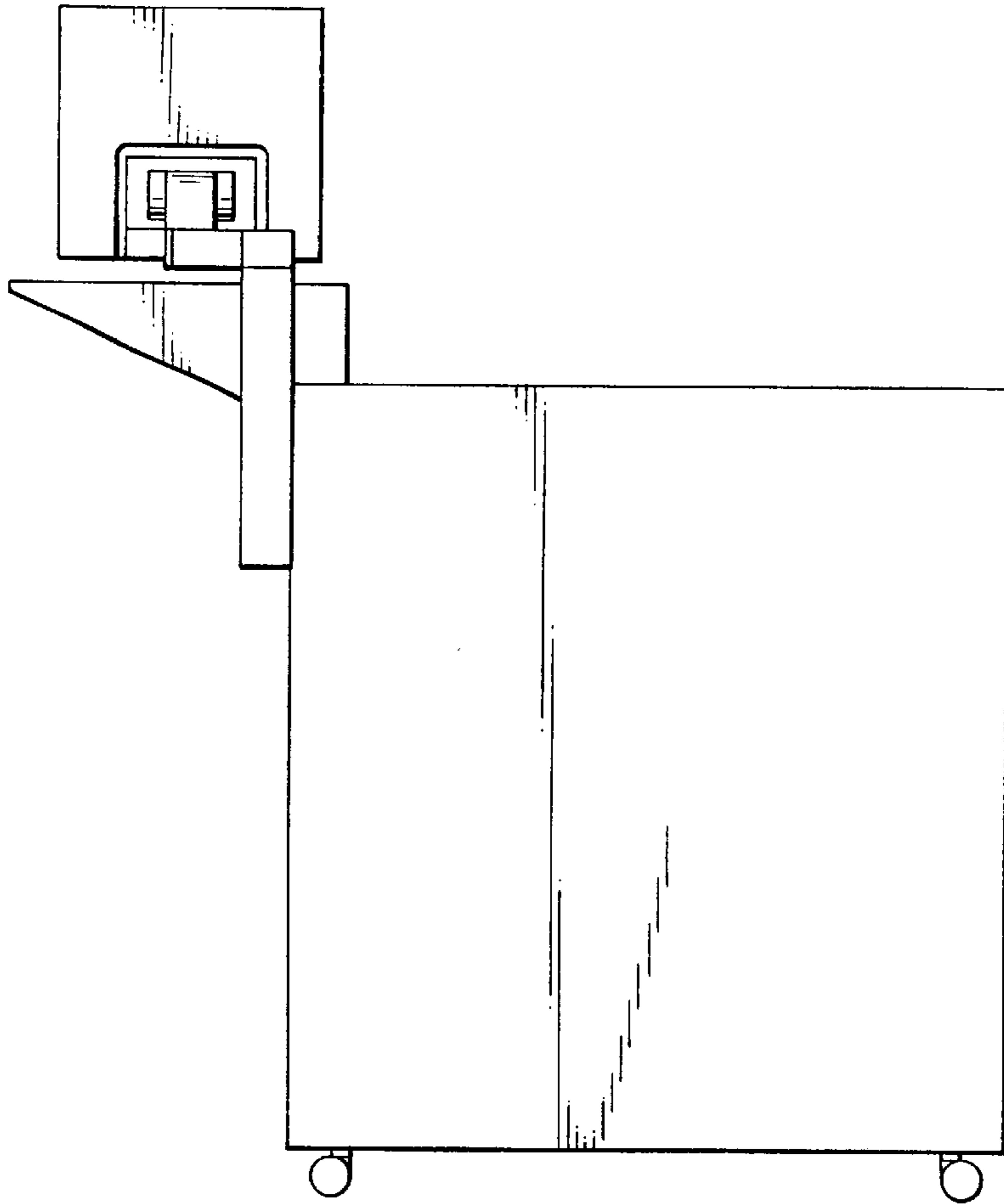

FIG. 5

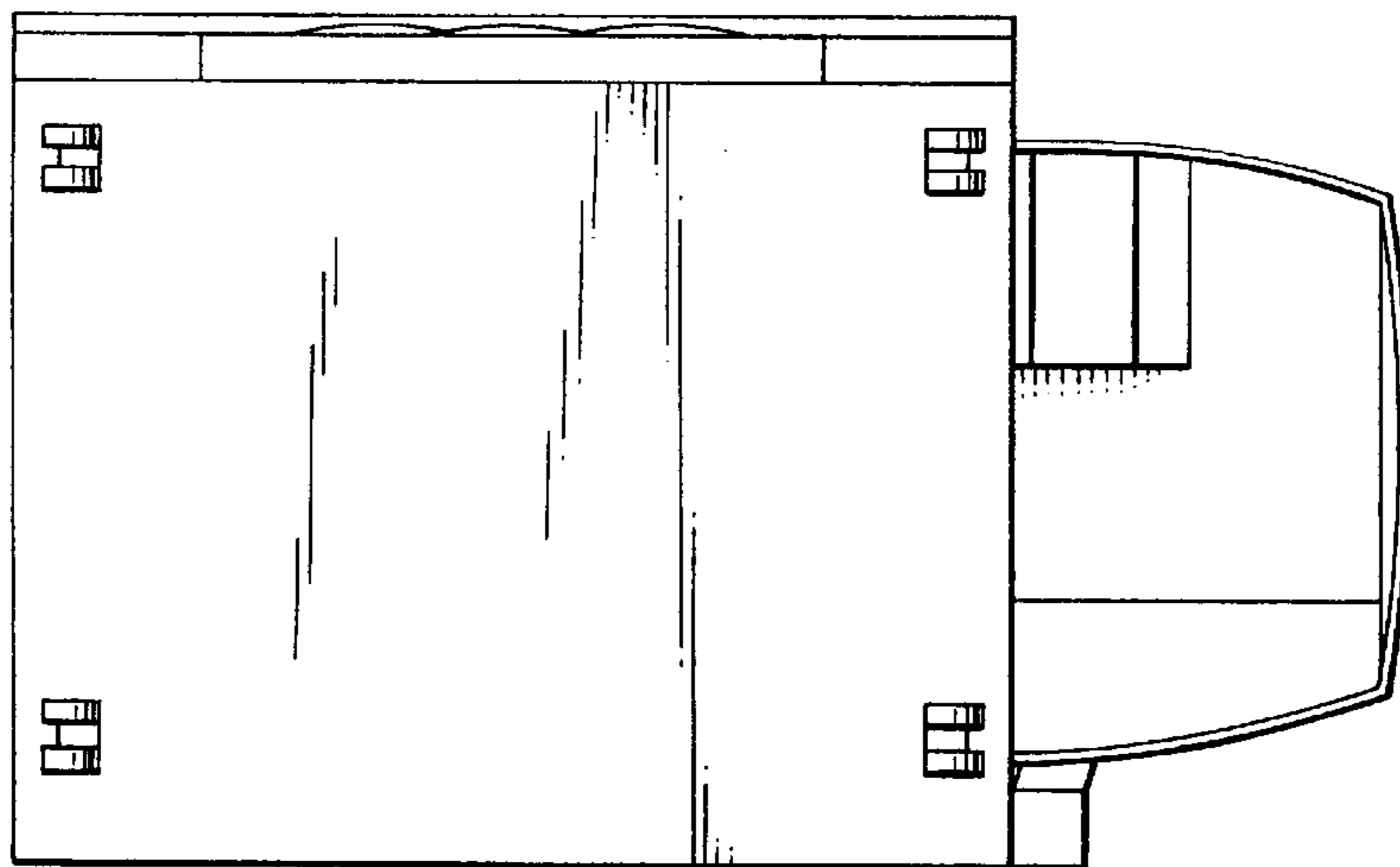

FIG. 6

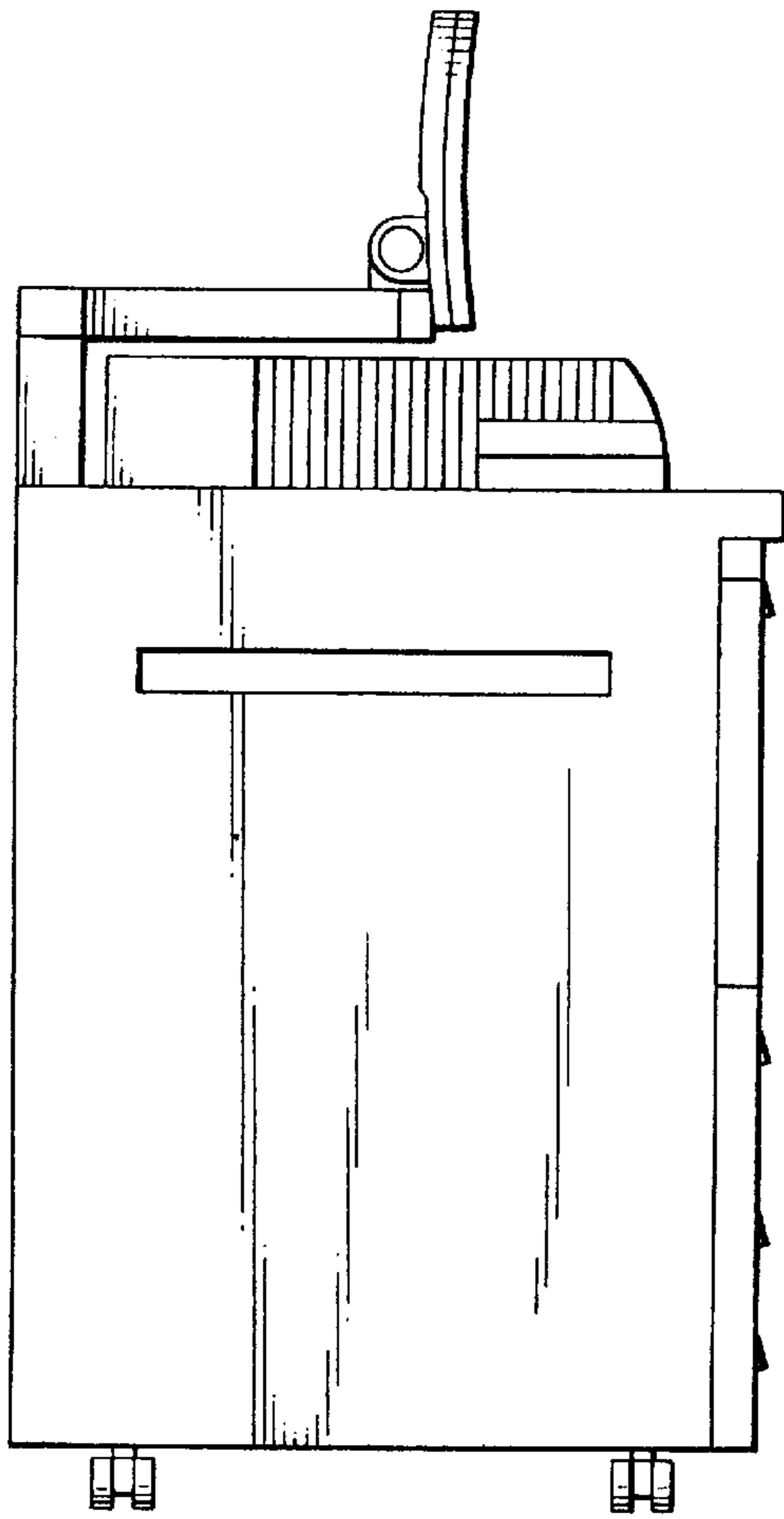

FIG. 7

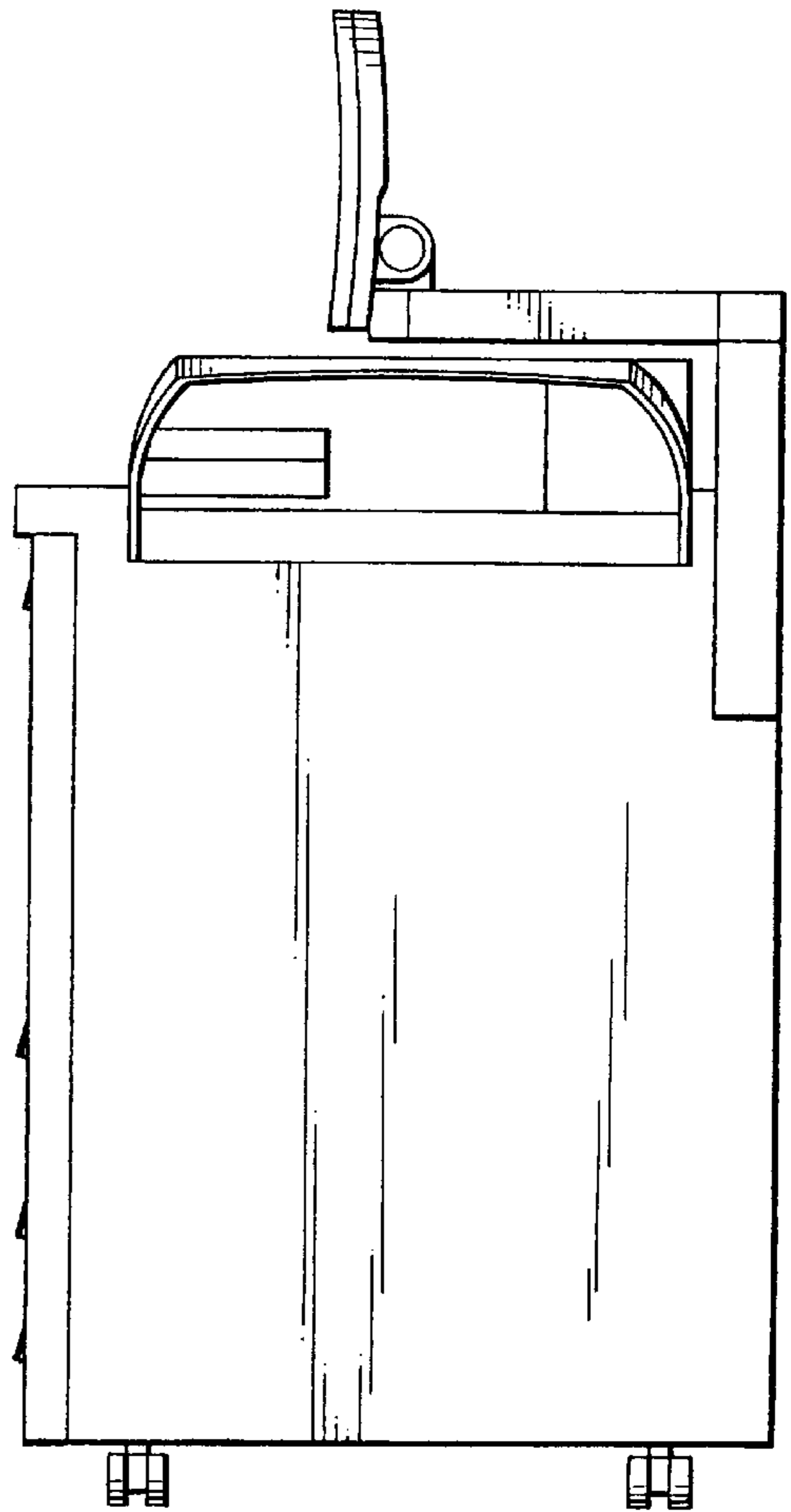

FIG.8

