



US00D443723S

(12) **United States Design Patent**
Kishimoto

(10) **Patent No.:** **US D443,723 S**

(45) **Date of Patent:** **** Jun. 12, 2001**

(54) **HAIR DRYER**

(75) Inventor: **Yoshinori Kishimoto**, Tottori (JP)

(73) Assignee: **Tottori Sanyo Electric Co., Ltd.**,
Tottori (JP)

(**) Term: **14 Years**

(21) Appl. No.: **29/127,034**

(22) Filed: **Jul. 26, 2000**

(30) **Foreign Application Priority Data**

Mar. 31, 2000 (JP) 12-008404

(51) **LOC (7) Cl.** **28-03**

(52) **U.S. Cl.** **D28/13**

(58) **Field of Search** D28/12, 13, 14,
D28/15; 132/271; 34/96, 97, 98; 392/384,
385

(56) **References Cited**

U.S. PATENT DOCUMENTS

D. 288,726 * 3/1987 Muller D28/13

D. 407,847 * 4/1999 Gudfin D28/13
D. 432,716 * 10/2000 Goetschi D28/13
4,198,558 * 4/1980 Benty 34/97 X
4,896,021 * 1/1990 Poweleit et al. 392/385

* cited by examiner

Primary Examiner—Paula A. Mortimer

(74) *Attorney, Agent, or Firm*—Darby & Darby

(57) **CLAIM**

We claim the ornamental design for a hair dryer, as shown and described.

DESCRIPTION

FIG. 1 is a perspective view of our new design for a hair dryer;

FIG. 2 is a left side elevation view of our new design;

FIG. 3 is a right side elevation view thereof;

FIG. 4 is a top plan view thereof;

FIG. 5 is a bottom plan view thereof;

FIG. 6 is a front elevation view thereof; and,

FIG. 7 is a rear elevation view thereof.

1 Claim, 4 Drawing Sheets

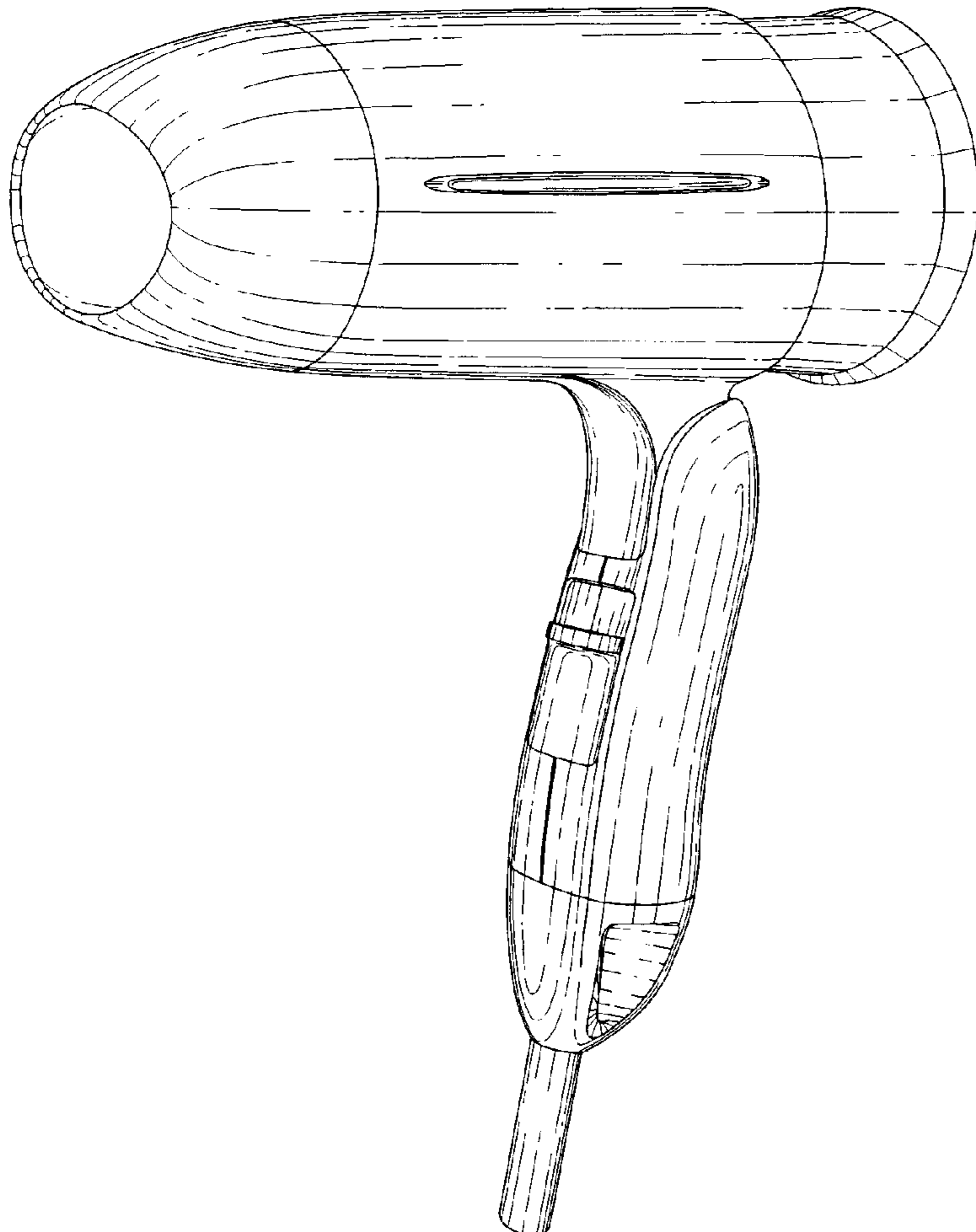

FIG. 1

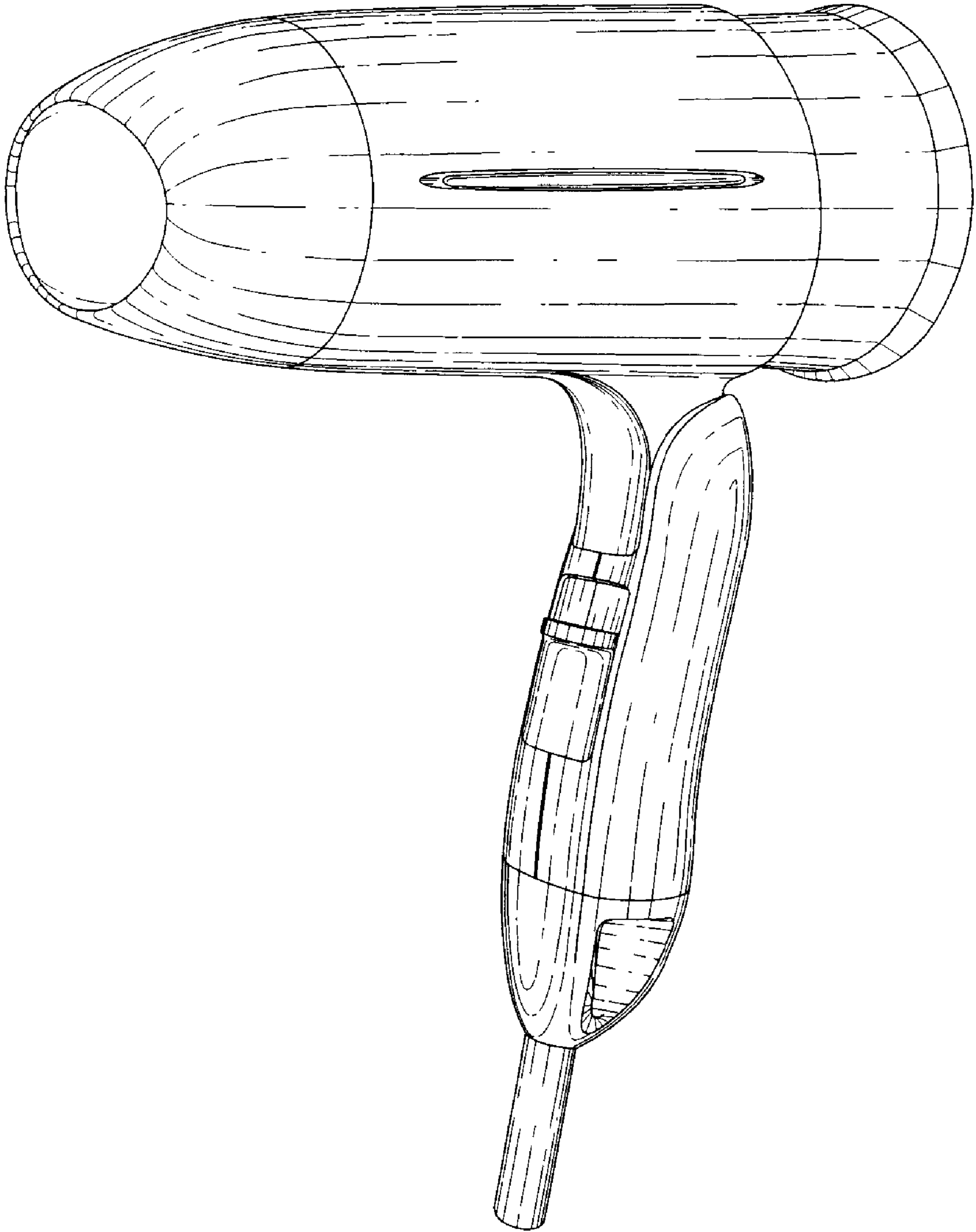

FIG. 2

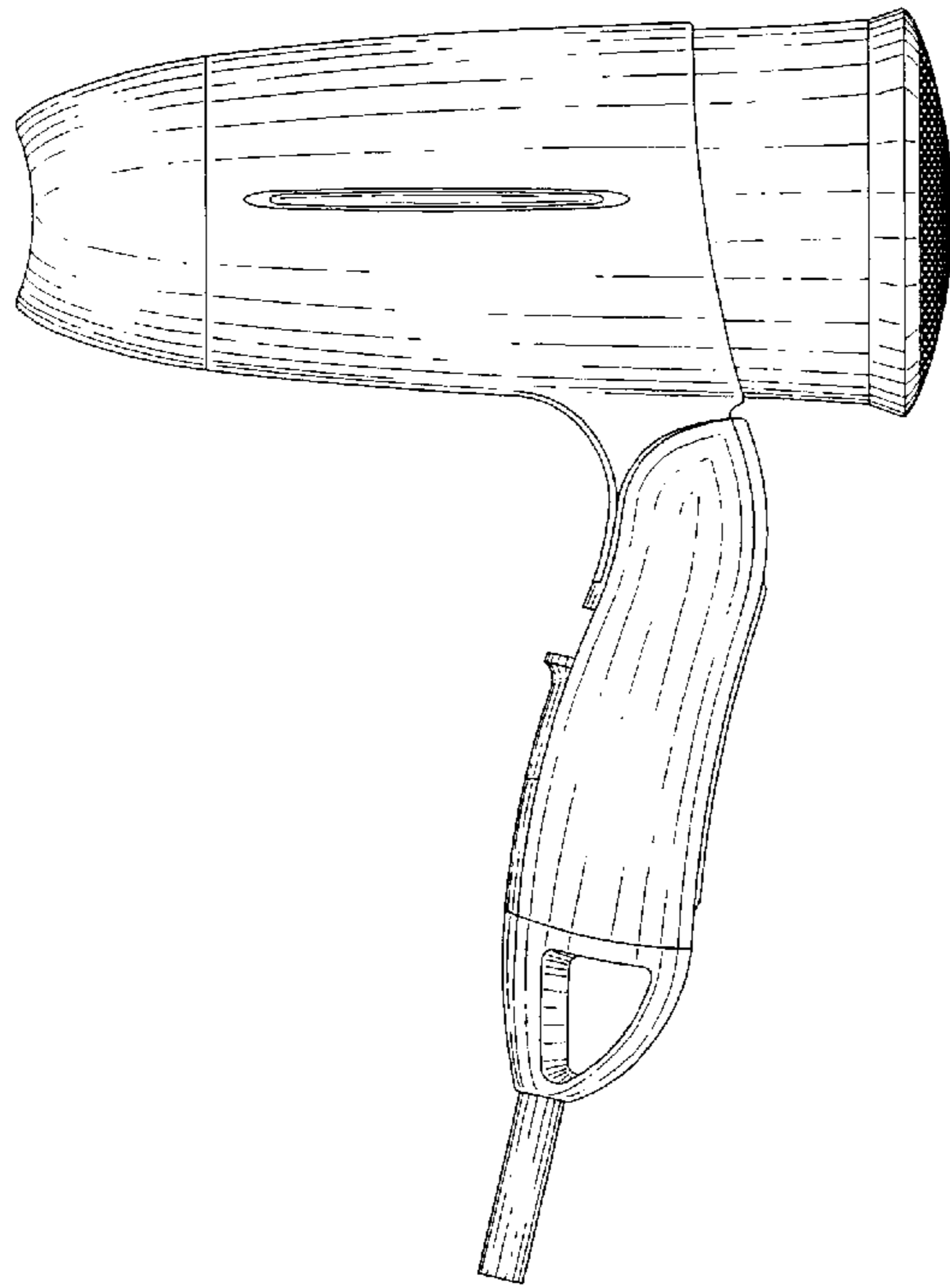

FIG. 3

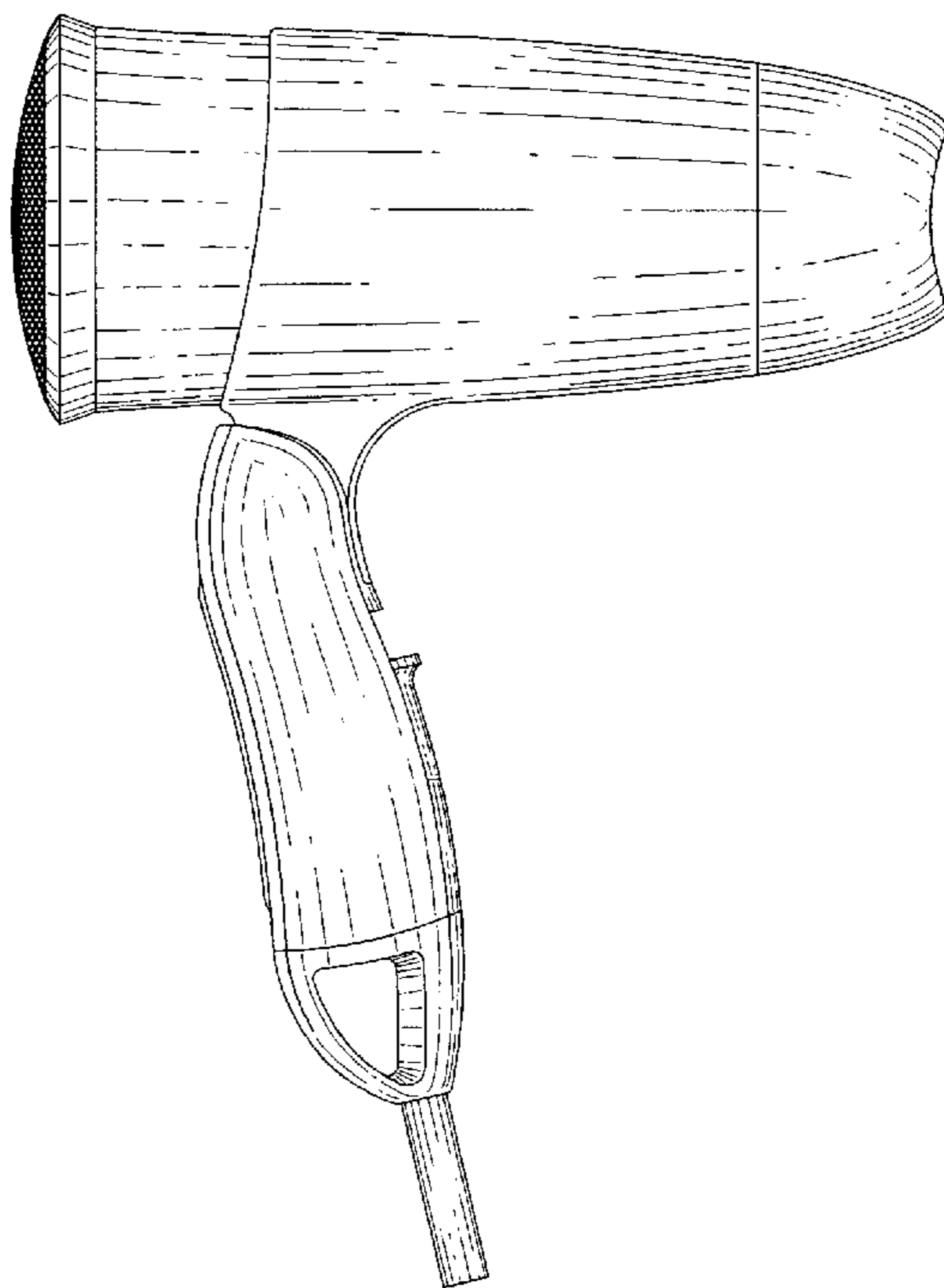

FIG. 4

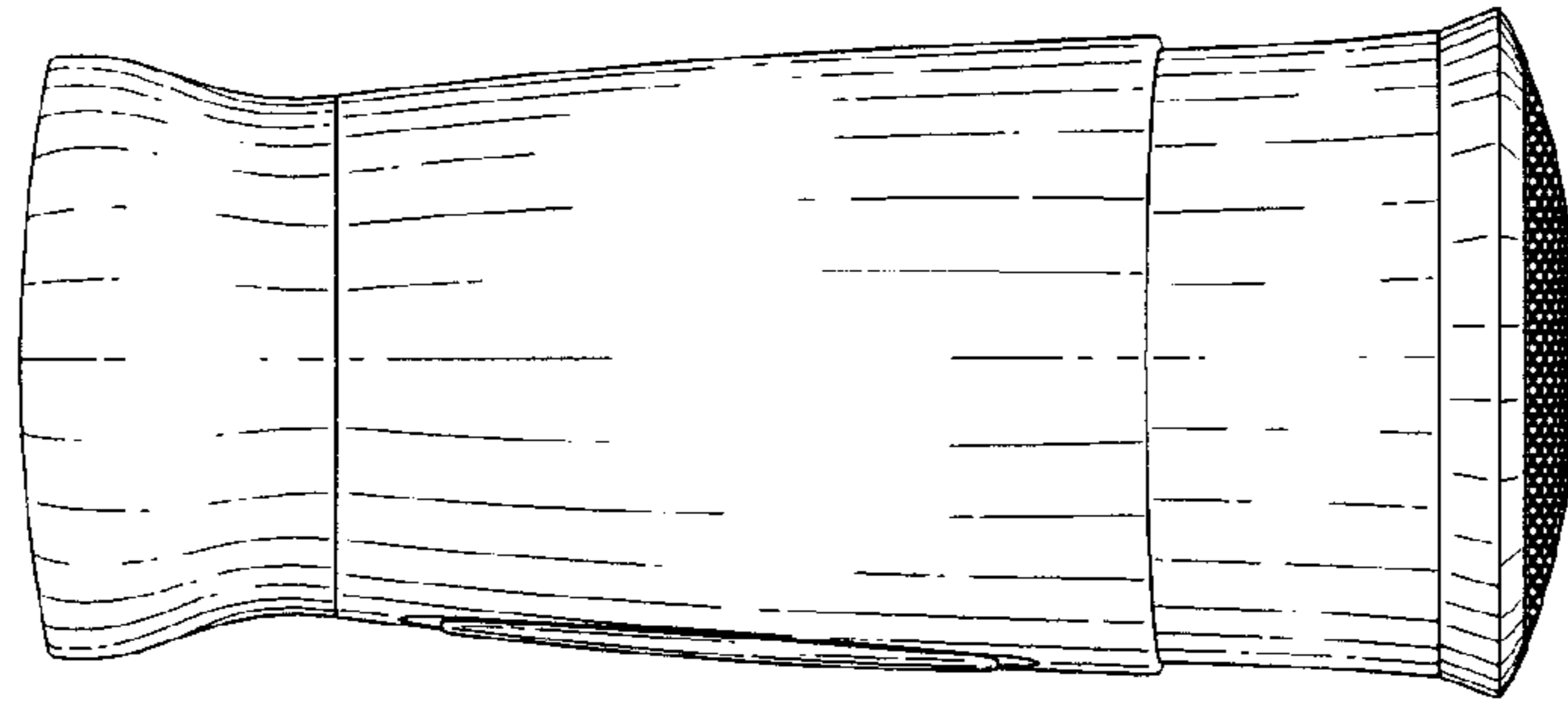

FIG. 5

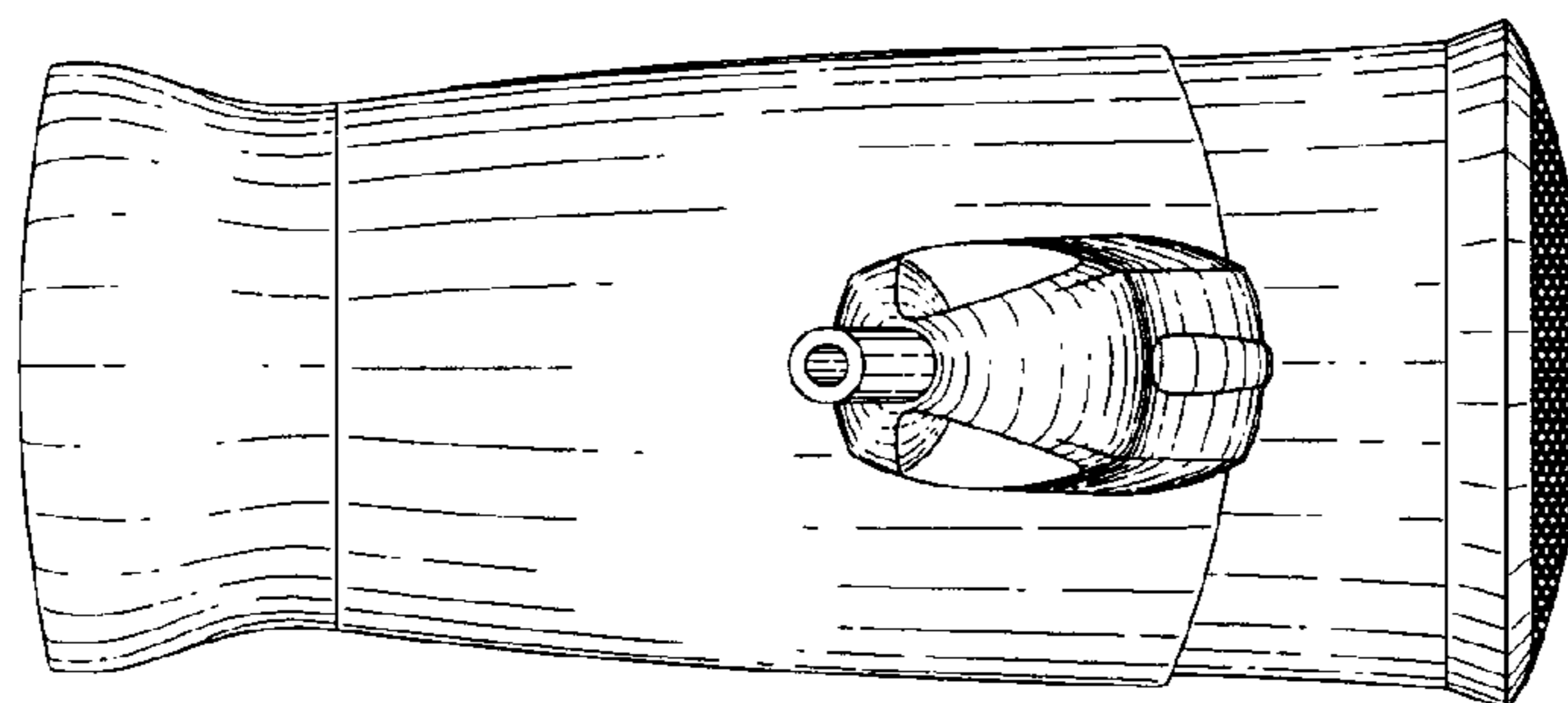

FIG. 6

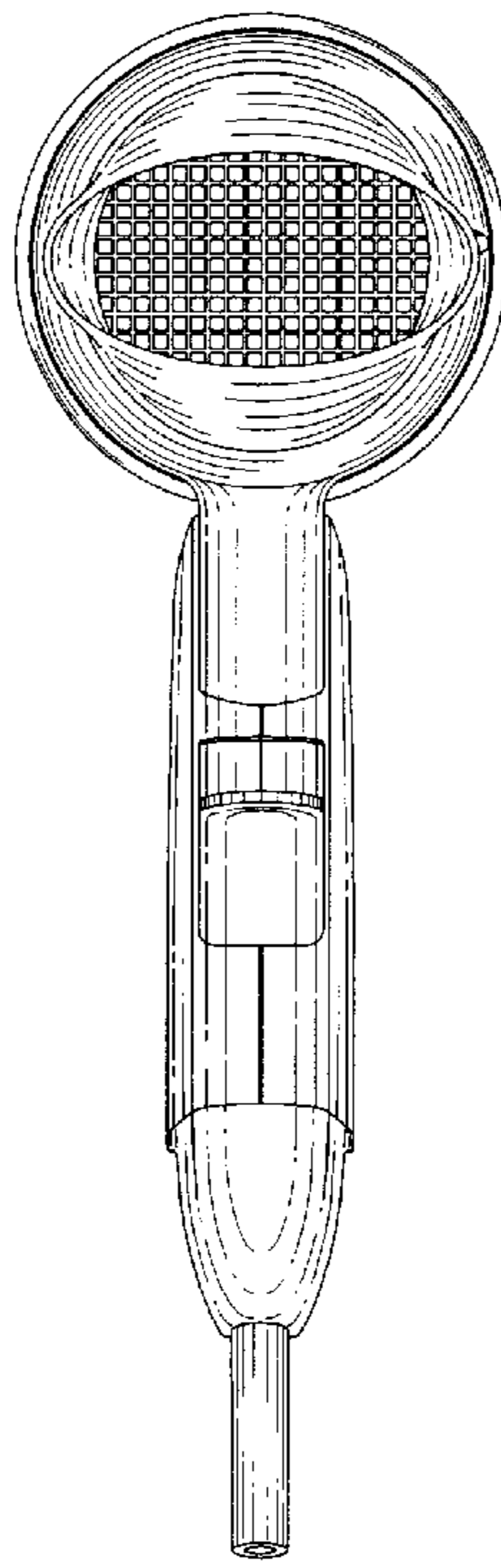

FIG. 7

