



US00D443699S

(12) **United States Design Patent**
Peters

(10) **Patent No.:** **US D443,699 S**

(45) **Date of Patent:** **** Jun. 12, 2001**

(54) **WALKBOARD**

(76) **Inventor:** **Terry L. Peters**, 10079 Mustang Cir.,
Keithville, LA (US) 71047

(**) **Term:** **14 Years**

(21) **Appl. No.:** **29/129,868**

(22) **Filed:** **Sep. 25, 2000**

(51) **LOC (7) Cl.** **25-04**

(52) **U.S. Cl.** **D25/62**

(58) **Field of Search** 269/910, 41; 227/154,
227/155; 182/2.8, 2.1, 222, 45; D25/62,
66

(56) **References Cited**

U.S. PATENT DOCUMENTS

D. 208,630	*	9/1967	Coblentz	D25/66
4,825,976	*	5/1989	Wyse	182/222
5,711,400	*	1/1998	Tan	182/222

* cited by examiner

Primary Examiner—Doris Clark

(74) *Attorney, Agent, or Firm*—John M. Harrison

(57) **CLAIM**

The ornamental design for a walkboard, as shown and described.

DESCRIPTION

FIG. 1 is a left side perspective view of the walkboard showing my new design;
FIG. 2 is a right side perspective view of the walkboard;
FIG. 3 is a right side elevational view thereof;
FIG. 4 is a left side elevational view thereof;
FIG. 5 is a left end view thereof;
FIG. 6 is a right end view thereof;
FIG. 7 is a top plan view thereof; and,
FIG. 8 is a bottom plan view of the walkboard illustrated in FIGS. 1-7.

1 Claim, 3 Drawing Sheets

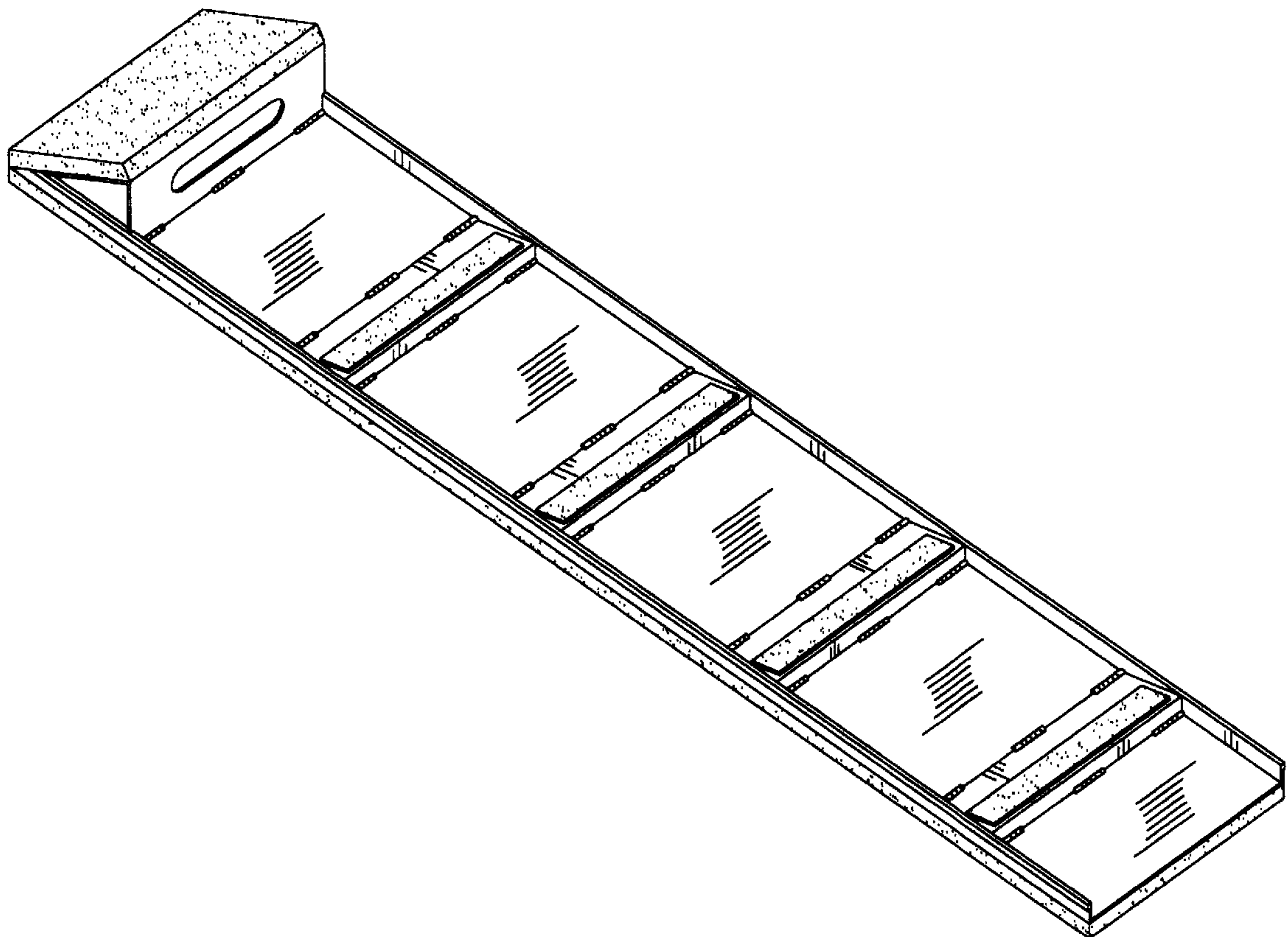

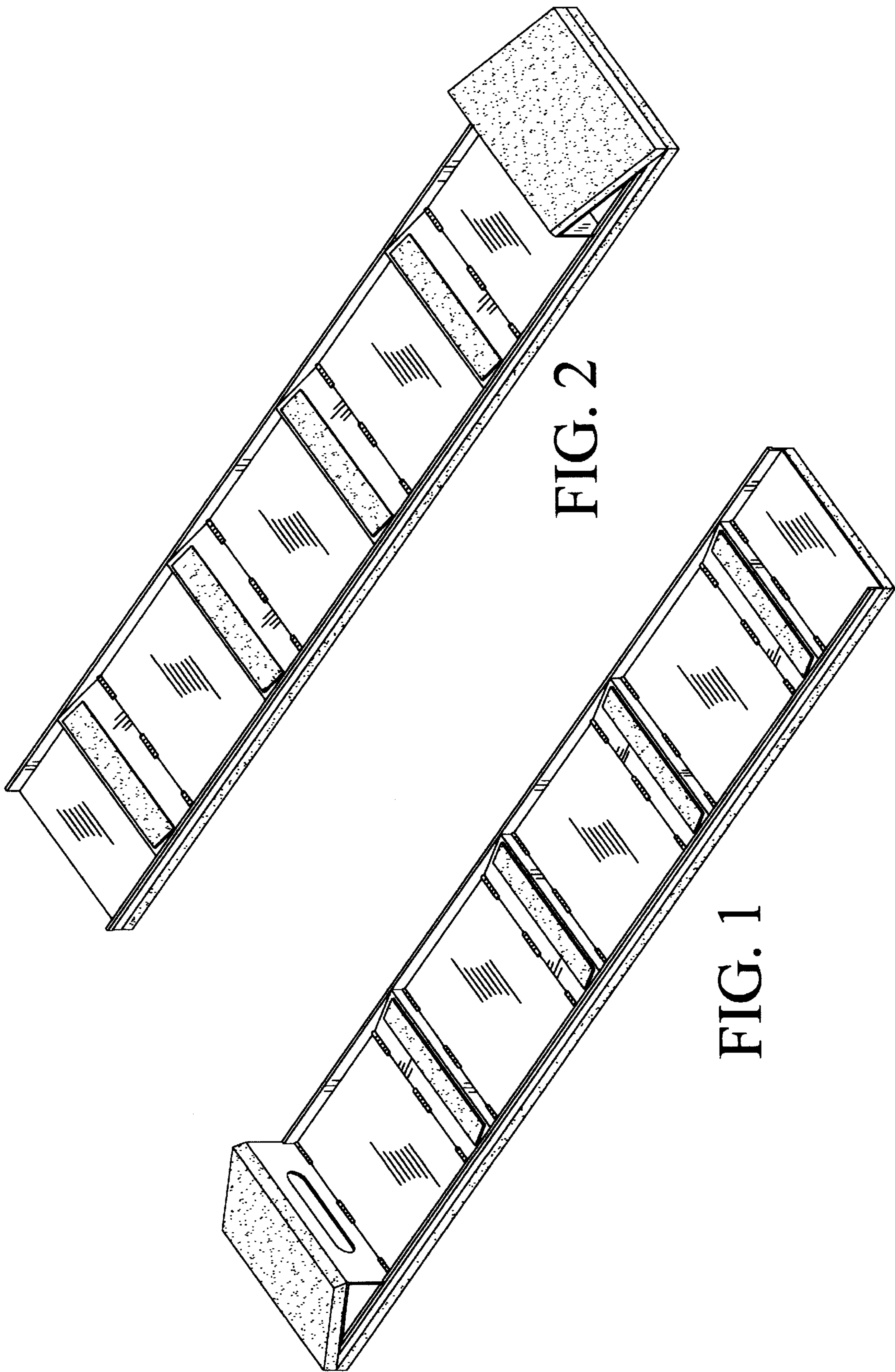

FIG. 2

FIG. 1

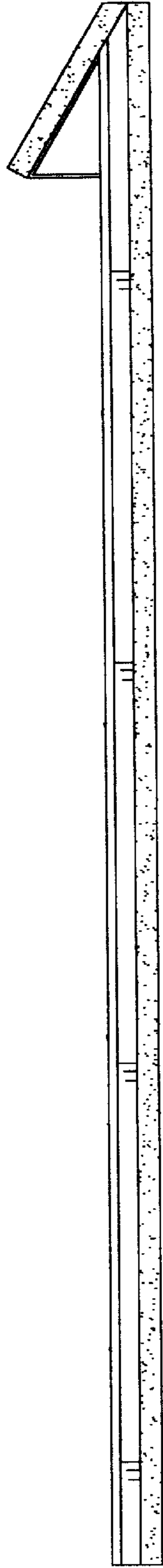

FIG. 3

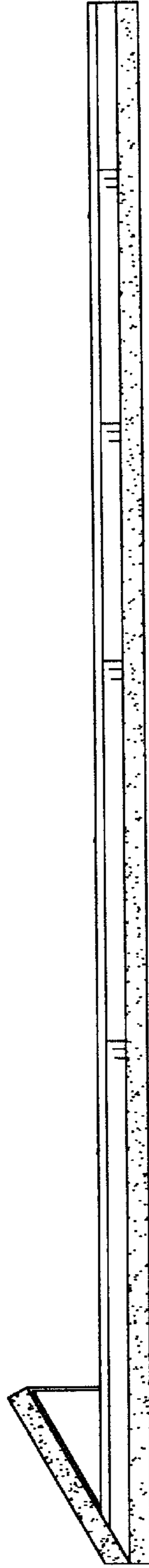

FIG. 4

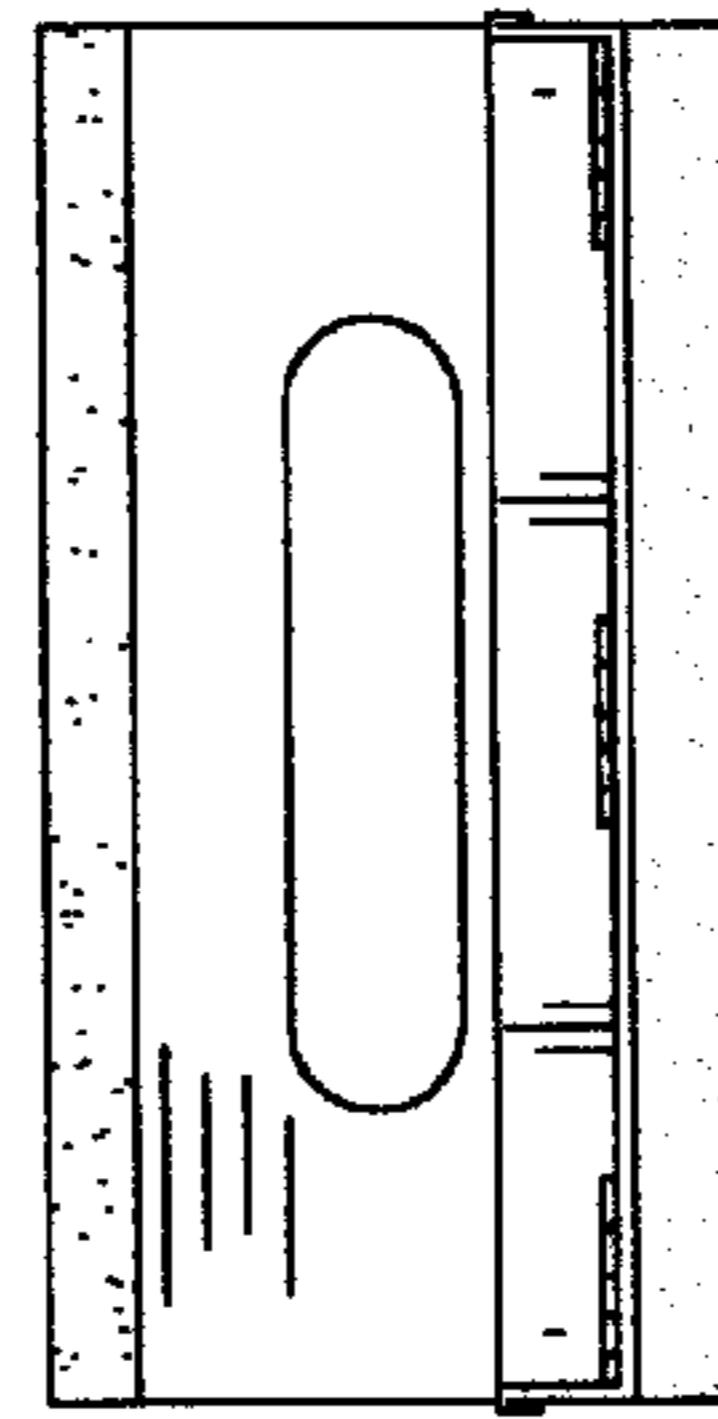

FIG. 5

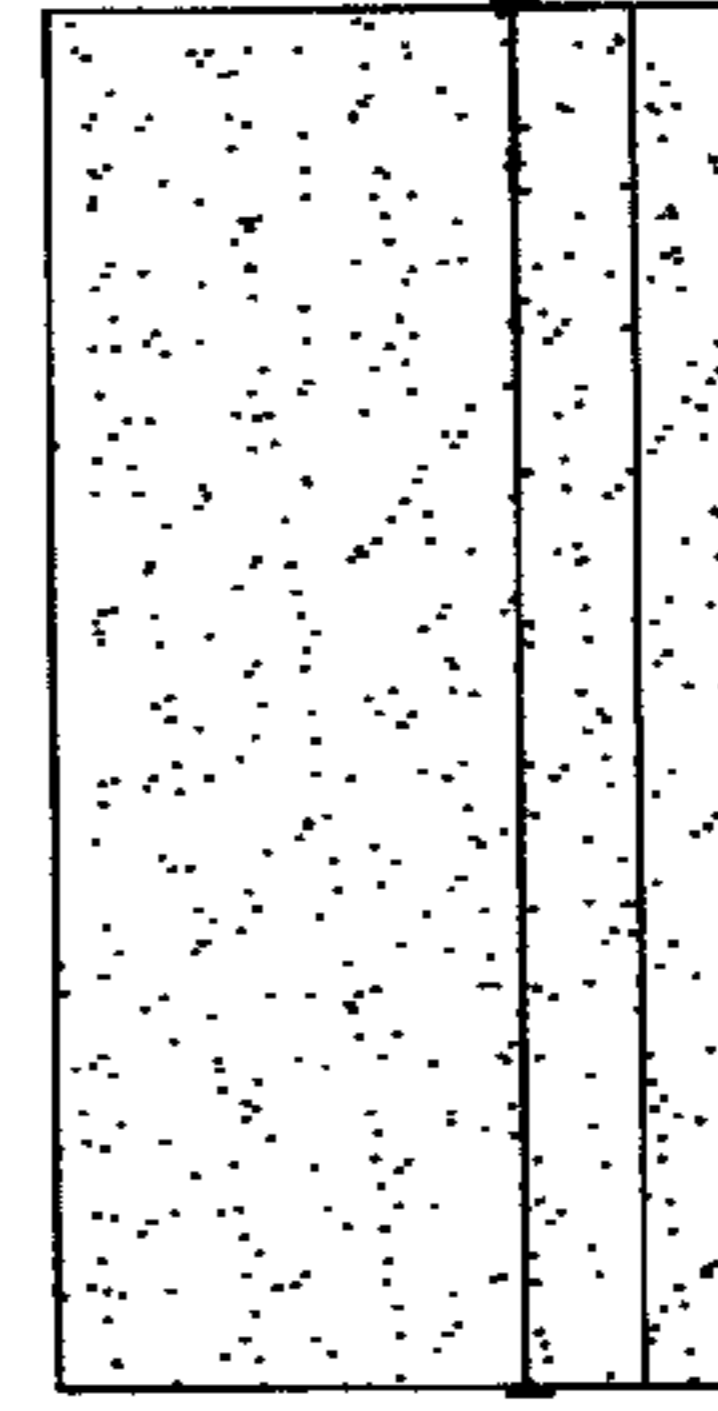

FIG. 6

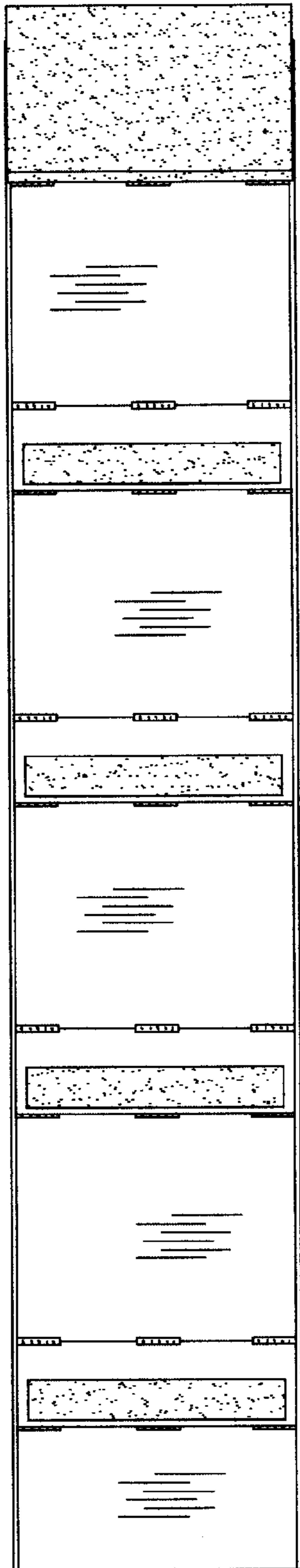

FIG. 7

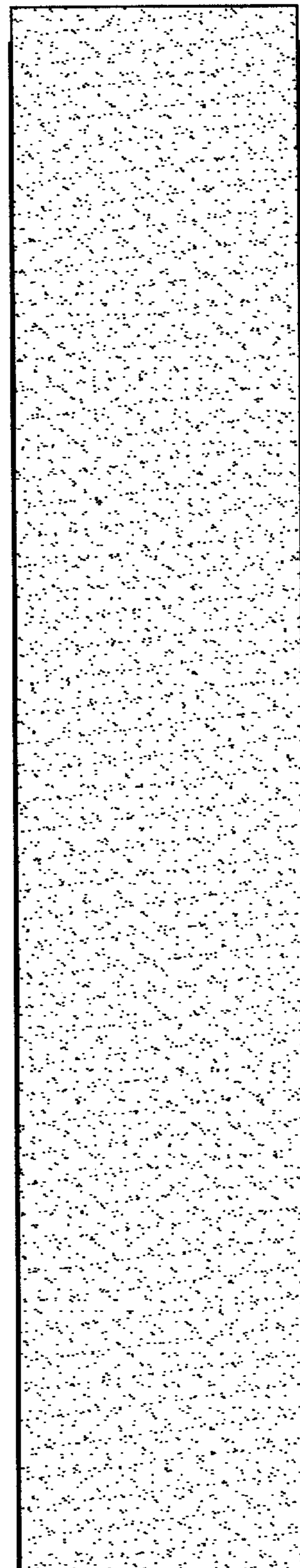

FIG. 8