



US00D443607S

(12) **United States Design Patent**  
**Kolinen**

(10) **Patent No.:** **US D443,607 S**

(45) **Date of Patent:** **\*\* Jun. 12, 2001**

(54) **FRONT COVER FOR A TELEPHONE  
HANDSET**

(75) Inventor: **Petteri Kolinen**, Helsinki (FI)

(73) Assignee: **Nokia Mobile Phones Ltd.**, Espoo (FI)

(\*\*) Term: **14 Years**

(21) Appl. No.: **29/124,517**

(22) Filed: **Jun. 7, 2000**

(30) **Foreign Application Priority Data**

Jan. 20, 2000 (FI) ..... M20000036

(51) **LOC (7) Cl.** ..... **14-03**

(52) **U.S. Cl.** ..... **D14/248**

(58) **Field of Search** ..... D14/137, 138,  
D14/218, 147-148, 247-248, 144, 341-347;  
379/433.434, 419, 420, 428, 440; 455/550-575,  
90

(56) **References Cited**

**U.S. PATENT DOCUMENTS**

D. 385,887	*	11/1997	Park	.....	D14/250
D. 391,253	*	2/1998	Meyer	.....	D14/138
D. 396,713	*	8/1998	Nuovo et al.	.....	D14/138
D. 398,930	*	9/1998	Nuovo et al.	.....	D14/250
D. 398,931	*	9/1998	Nuovo et al.	.....	D14/250
D. 402,981	*	12/1998	Galletti et al.	.....	D14/138
D. 406,583	*	3/1999	Phillips et al.	.....	D14/138
D. 406,585	*	3/1999	Vuolteenaho et al.	.....	D14/138
D. 410,002	*	5/1999	Collins	.....	D14/138

D. 411,205	*	6/1999	Frye et al.	.....	D14/250
D. 412,710	*	8/1999	Nuovo	.....	D14/250
D. 413,325	*	8/1999	Lee	.....	D14/138
D. 420,680	*	2/2000	Curtis	.....	D14/248
D. 421,442	*	3/2000	Curtis et al.	.....	D14/248
D. 422,597	*	4/2000	Finkbeiner	.....	D14/248
D. 425,074	*	5/2000	Frye et al.	.....	D14/248
D. 428,001	*	7/2000	Curtis	.....	D14/248
D. 429,491	*	8/2000	Finkbeiner	.....	D14/248
D. 433,397	*	11/2000	Ogawa	.....	D14/138
5,982,881	*	11/1999	Mischenko	.....	379/433
6,006,074	*	12/1999	De Larminat et al.	.....	455/90

\* cited by examiner

*Primary Examiner*—Jeffrey Asch

(74) *Attorney, Agent, or Firm*—Brian T. Rivers

(57) **CLAIM**

The ornamental design for the front cover for a telephone handset, as shown.

**DESCRIPTION**

FIG. 1 is a perspective front view of the new design applied to the front cover for a telephone handset;  
FIG. 2 is a perspective rear view thereof;  
FIG. 3 is a bottom end view thereof;  
FIG. 4 is a right side view thereof;  
FIG. 5 is a rear view thereof;  
FIG. 6 is a front view thereof;  
FIG. 7 is a left side view thereof; and,  
FIG. 8 is a top end view thereof.

**1 Claim, 3 Drawing Sheets**

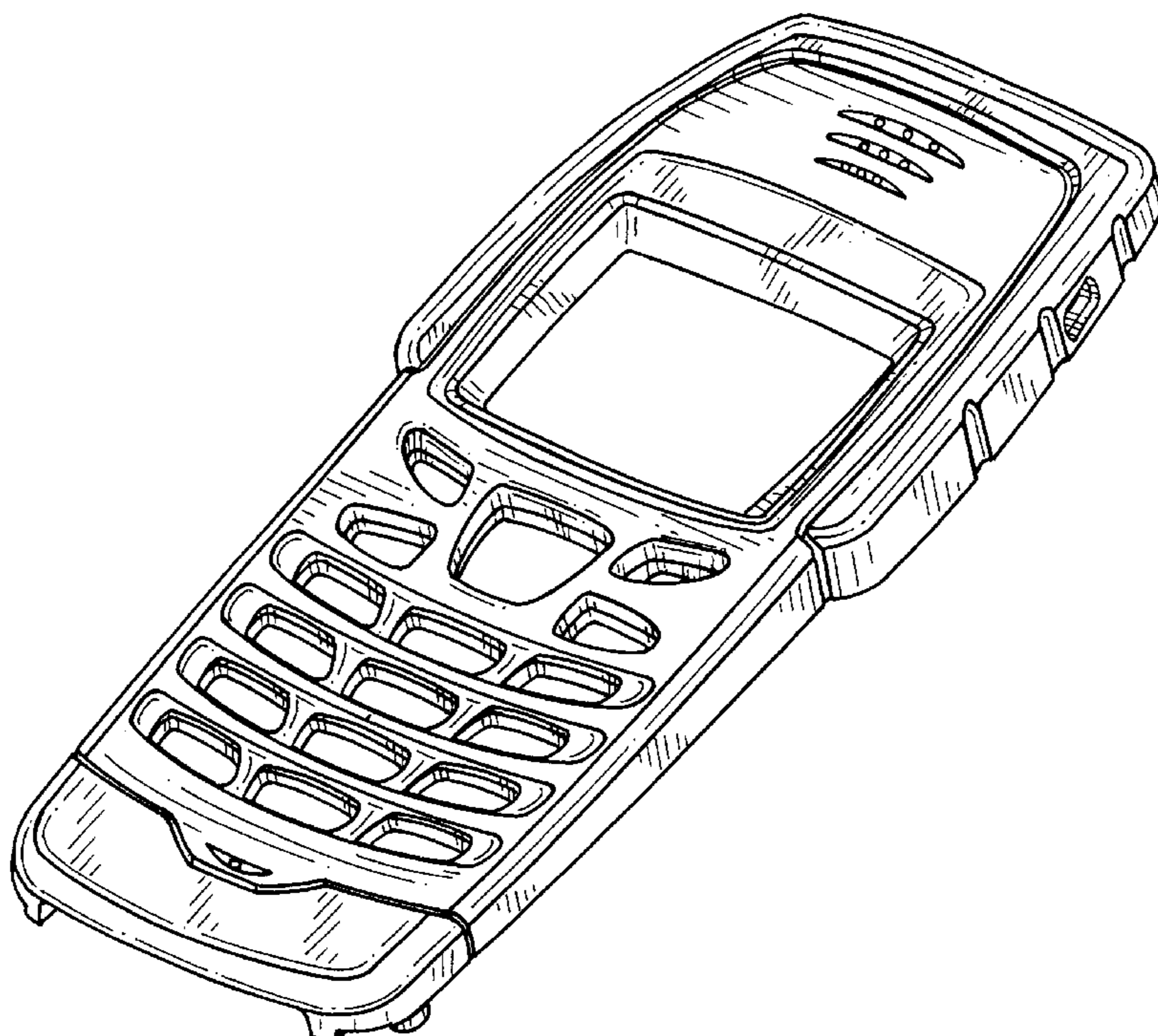

FIG. 1

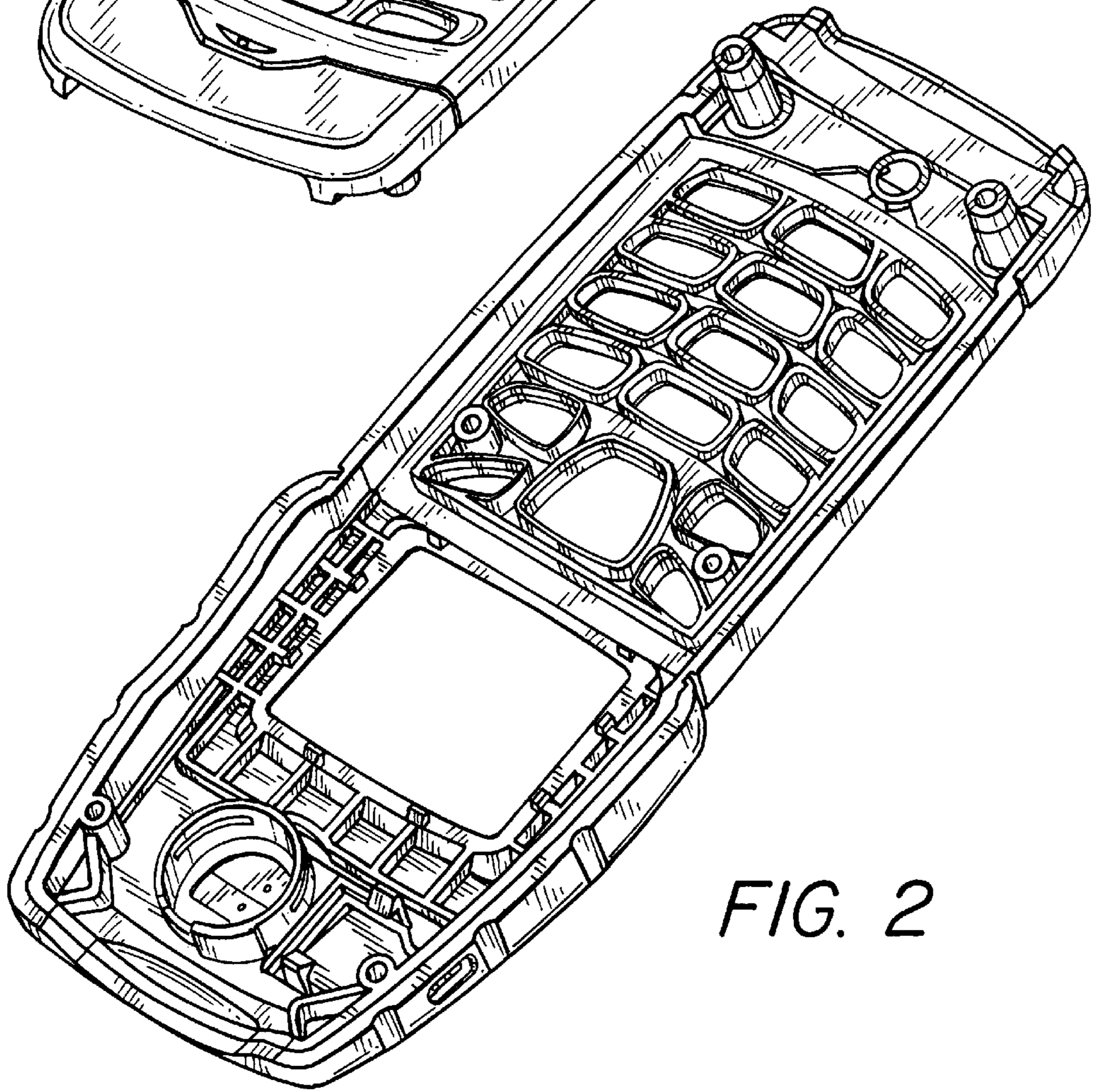
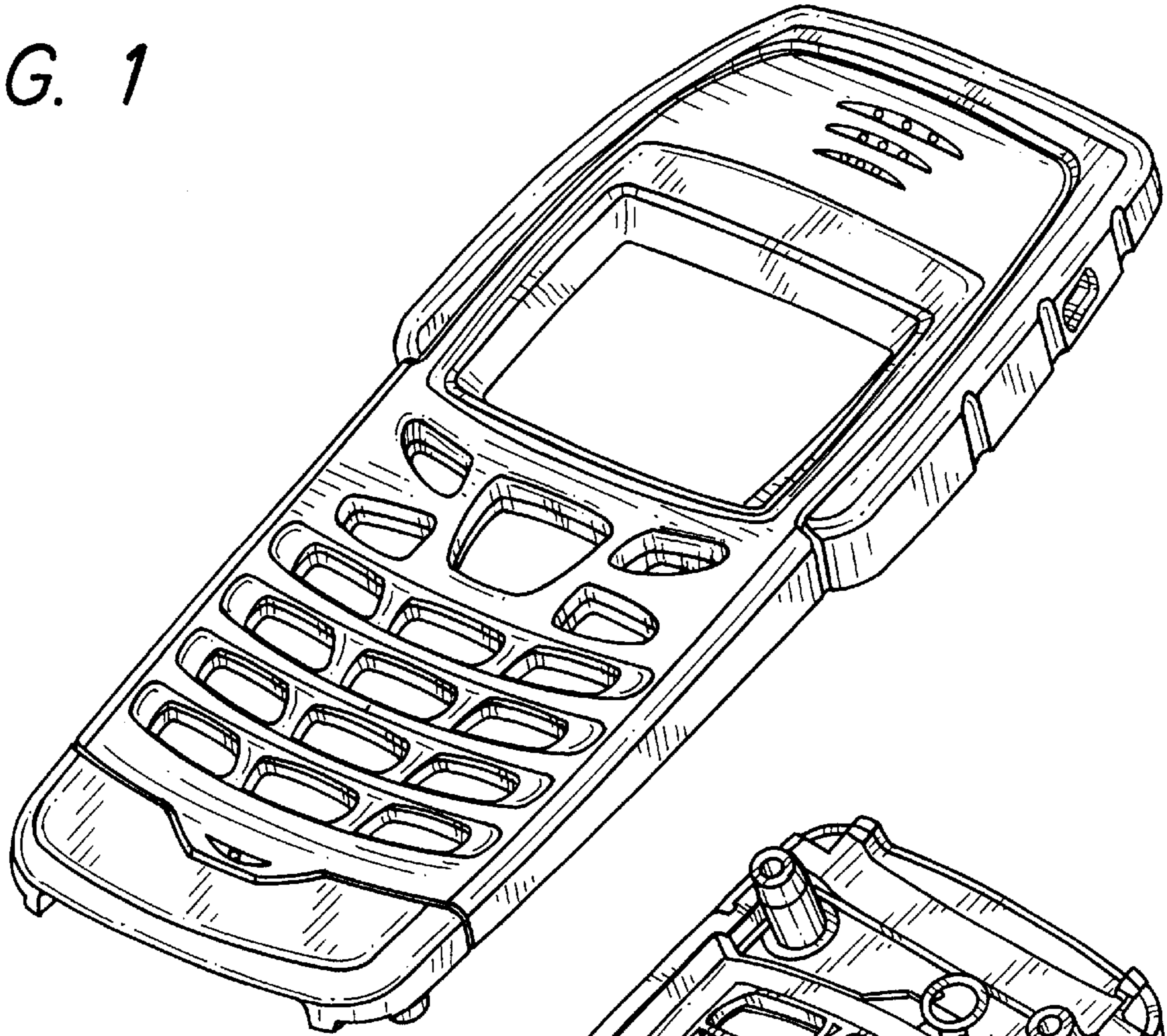

FIG. 2

FIG. 3

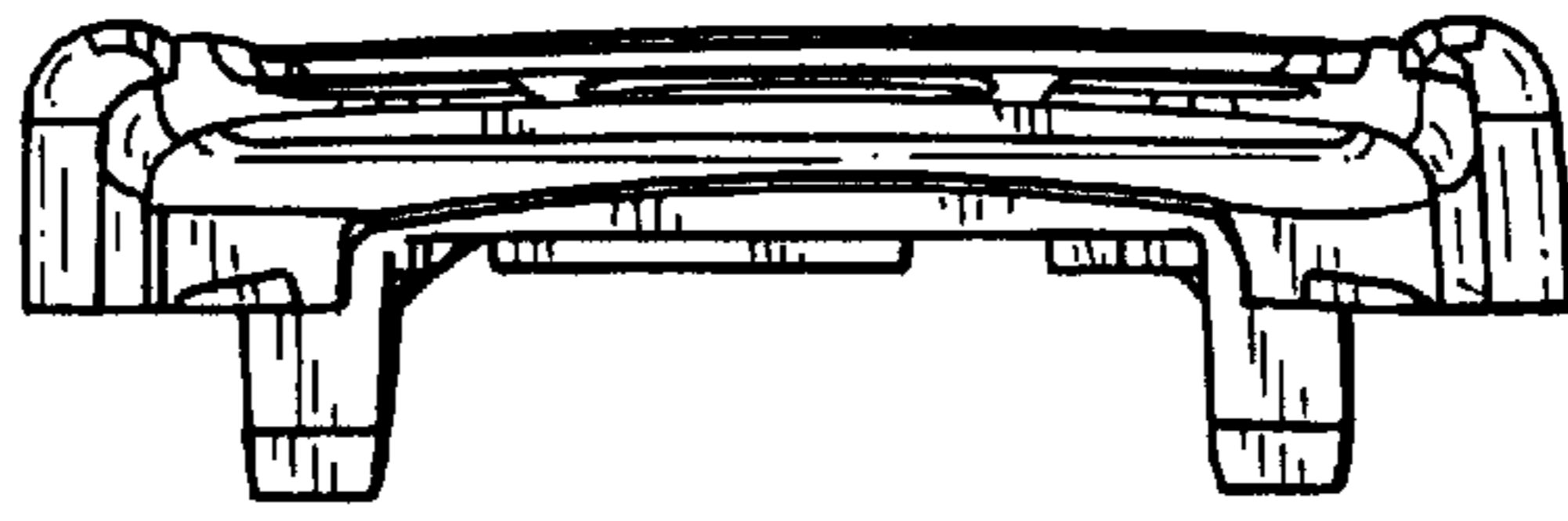

FIG. 4

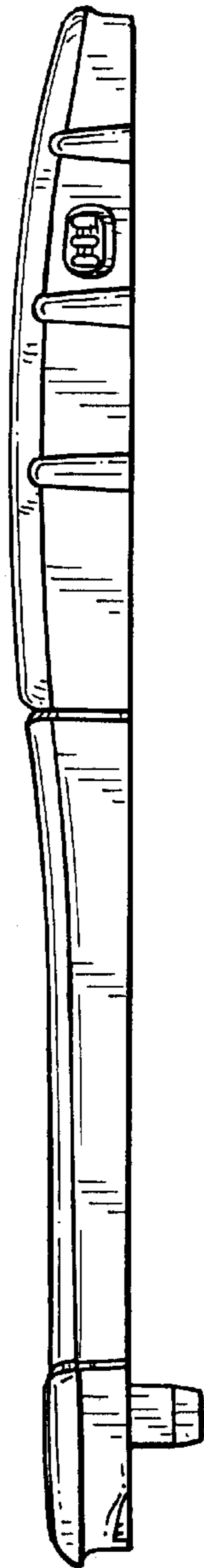

FIG. 5

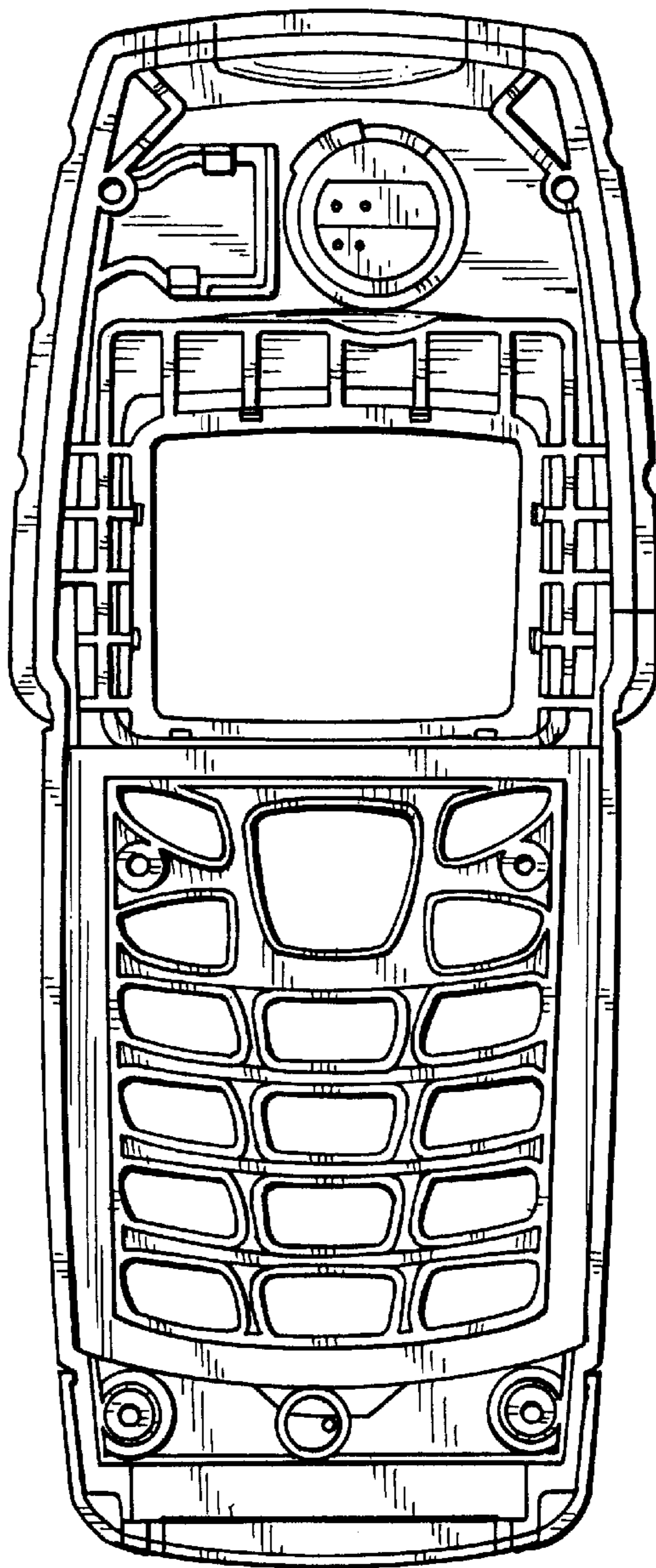

FIG. 6

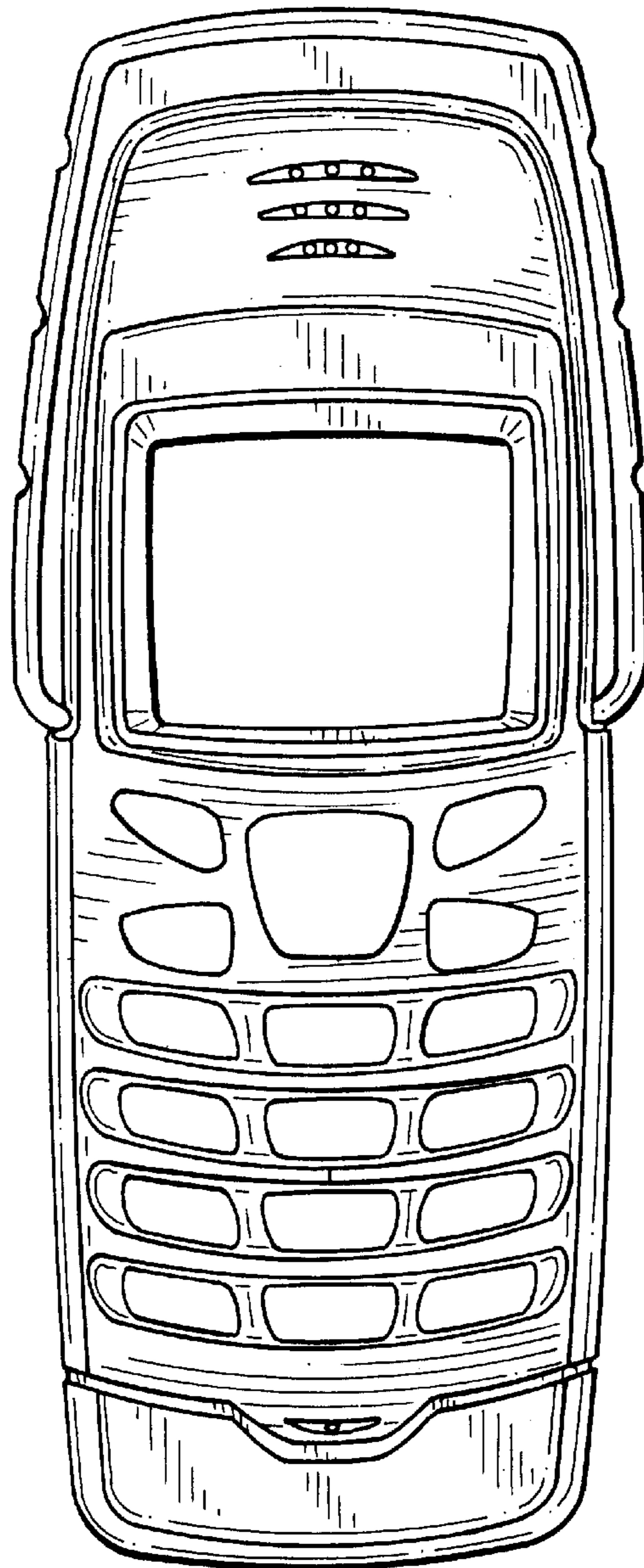

FIG. 7

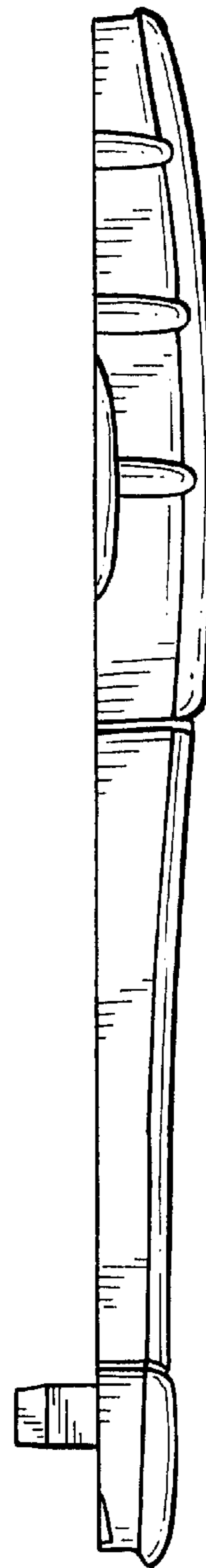

FIG. 8

