



US00D443524S

(12) **United States Design Patent**  
**Duke**

(10) **Patent No.:** **US D443,524 S**

(45) **Date of Patent:** **\*\* Jun. 12, 2001**

(54) **CLOCK**

(75) Inventor: **James B. Duke**, Duluth, GA (US)

(73) Assignee: **GTC Properties, Inc.**, Wilmington, DE (US)

(\*\*) Term: **14 Years**

(21) Appl. No.: **29/130,747**

(22) Filed: **Oct. 6, 2000**

(51) **LOC (7) Cl.** ..... **10-01**

(52) **U.S. Cl.** ..... **D10/15; D10/18**

(58) **Field of Search** ..... D10/1-40, 122-132;  
368/10, 276, 277, 285, 316-317; D14/100,  
341, 345, 346, 347, 171, 218, 191; D13/168;  
D18/2, 7; D19/21

(56) **References Cited**

**U.S. PATENT DOCUMENTS**

D. 301,580	*	6/1989	Davidson	.....	D14/171
D. 311,908	*	11/1990	Molyneaux	.....	D14/106
D. 342,501	*	12/1993	Saeki et al.	.....	D14/126
D. 363,069	*	10/1995	Bro	.....	D14/191
D. 363,881	*	11/1995	Yung	.....	D10/18
D. 366,835	*	2/1996	Sell	.....	D10/15
D. 387,996	*	12/1997	Chan	.....	D10/18
D. 391,257	*	2/1998	Ngan	.....	D14/171
D. 420,663	*	2/2000	Goldenberg et al.	.....	D14/138
D. 428,414	*	7/2000	Okumura	.....	D14/345
D. 430,554	*	9/2000	Nguyen et al.	.....	D14/191

D. 434,070 \* 11/2000 Lin et al. .... D19/21

\* cited by examiner

*Primary Examiner*—Jeffrey Asch

(74) *Attorney, Agent, or Firm*—Jones, Day, Reavis & Pogue

(57) **CLAIM**

The ornamental design for a clock, as shown and described.

**DESCRIPTION**

FIG. 1 is a perspective view of the clock of the present invention in an open position;  
 FIG. 2 is a front elevational view of the clock of FIG. 1 in an open position;  
 FIG. 3 is a top plan view of the clock of FIG. 1 in an open position;  
 FIG. 4 is a right side elevational view of the clock of FIG. 1 in an open position, the left side being a mirror image;  
 FIG. 5 is a perspective view of the clock of FIG. 1 in a closed position;  
 FIG. 6 is a front elevational view of the clock of FIG. 1 in a closed position;  
 FIG. 7 is a top plan view of the clock of FIG. 1 in a closed position; and,  
 FIG. 8 is a right side elevational view of the clock of FIG. 1 in a closed position, the left side being a mirror image.  
 The broken line showing of “buttons” and other representations appearing in FIGS. 1-3 are for environmental purposes only and forms no part of the claimed design.

**1 Claim, 4 Drawing Sheets**

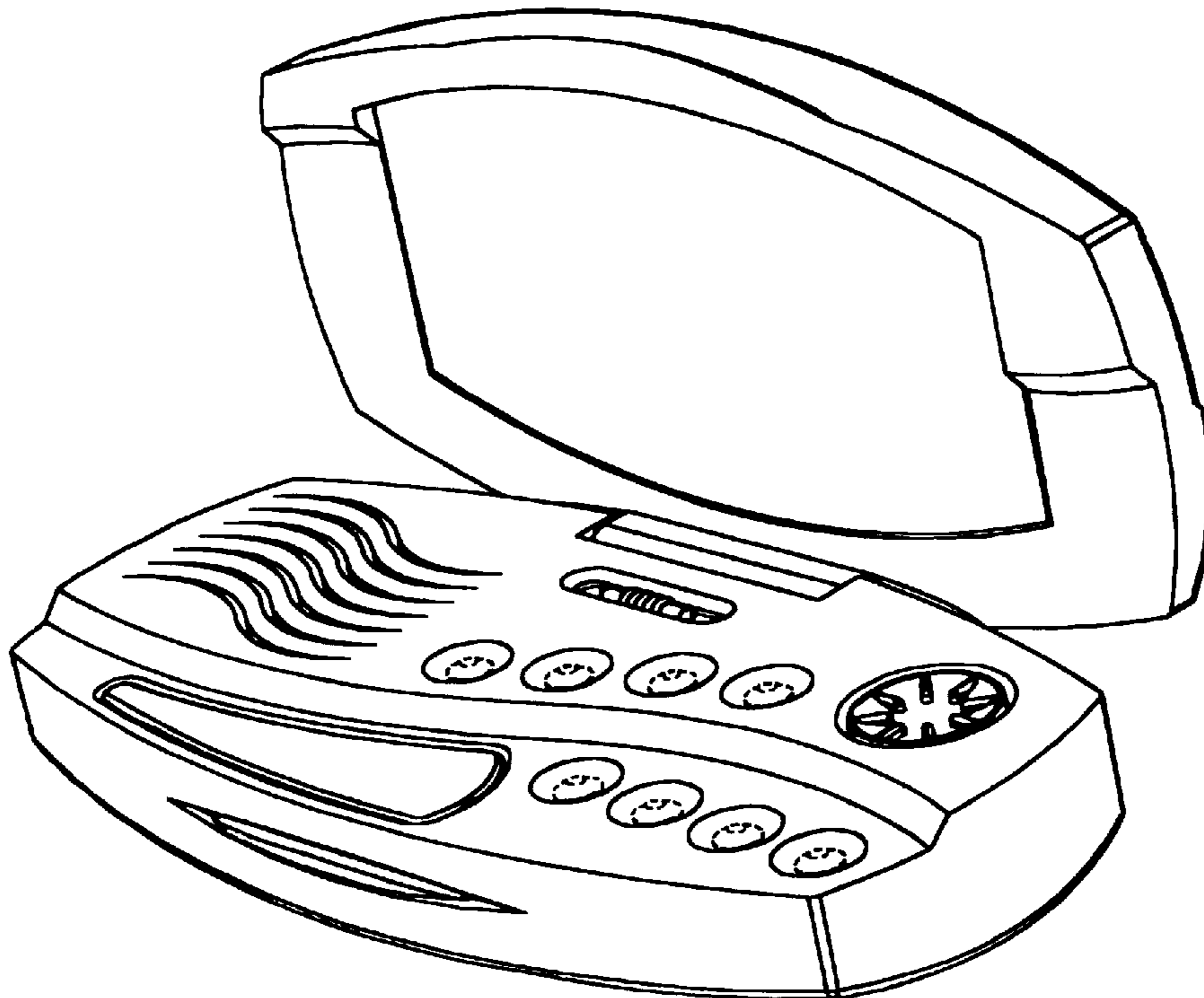

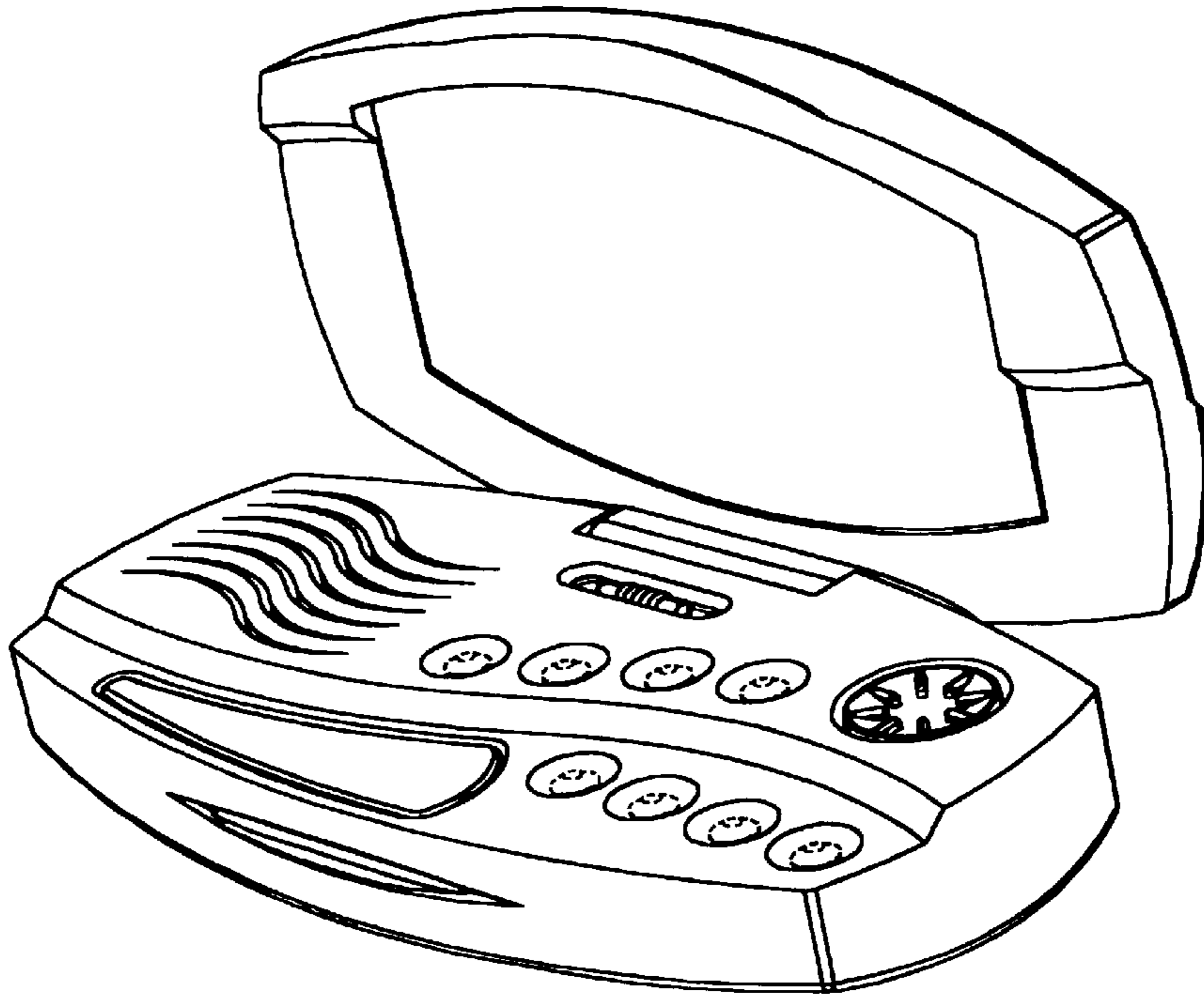

FIG. 1

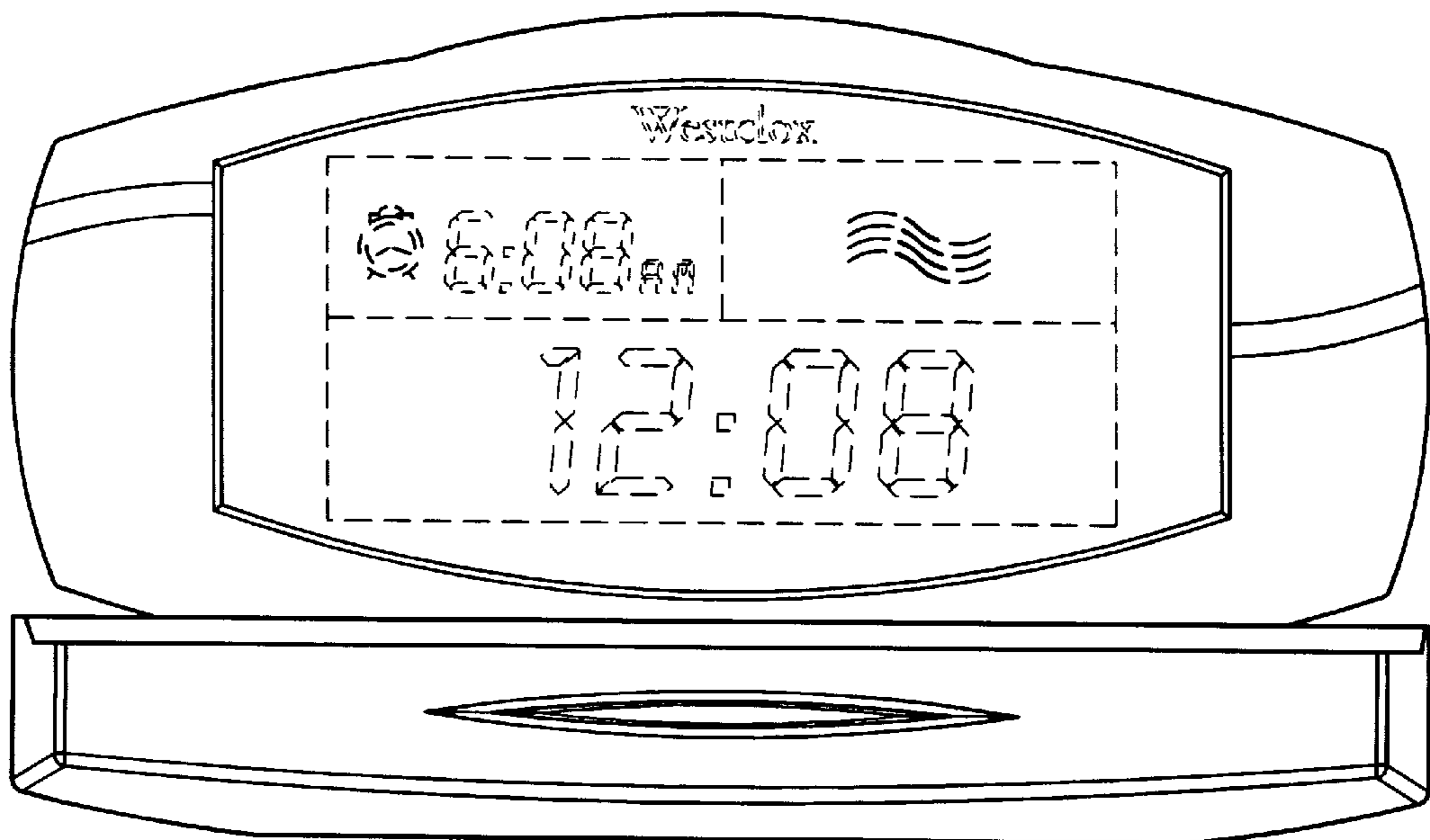

FIG. 2

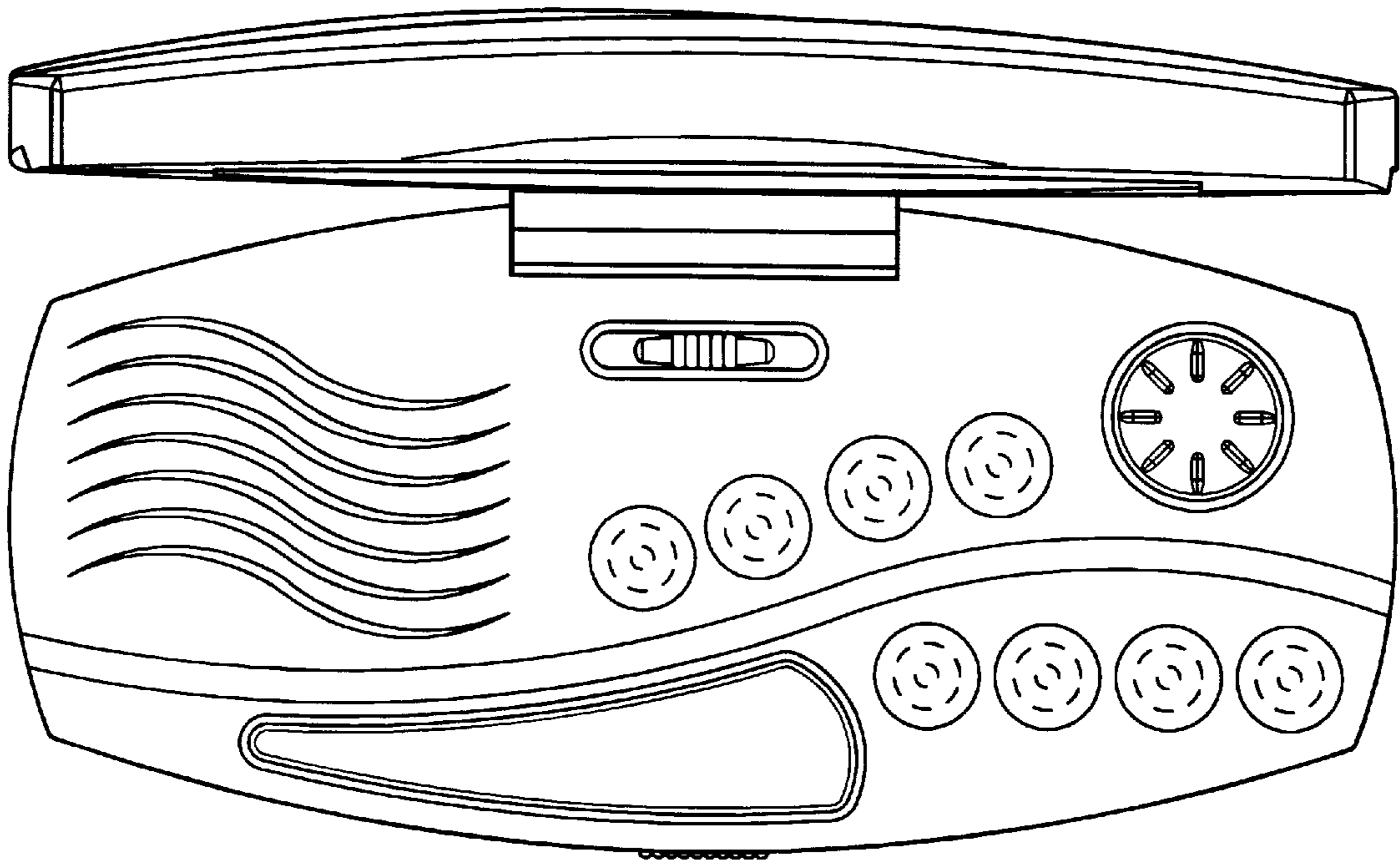

FIG. 3

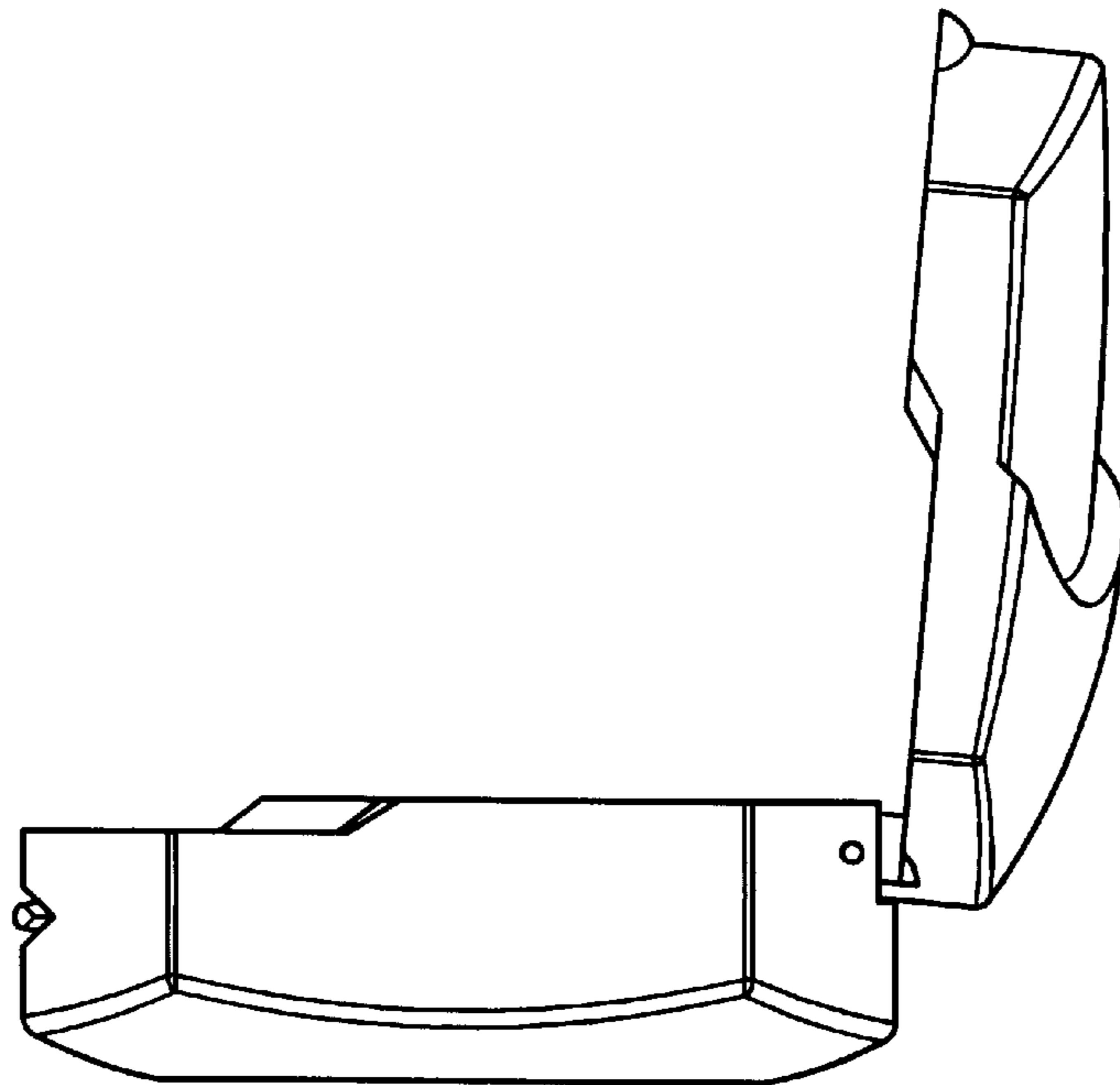

FIG. 4

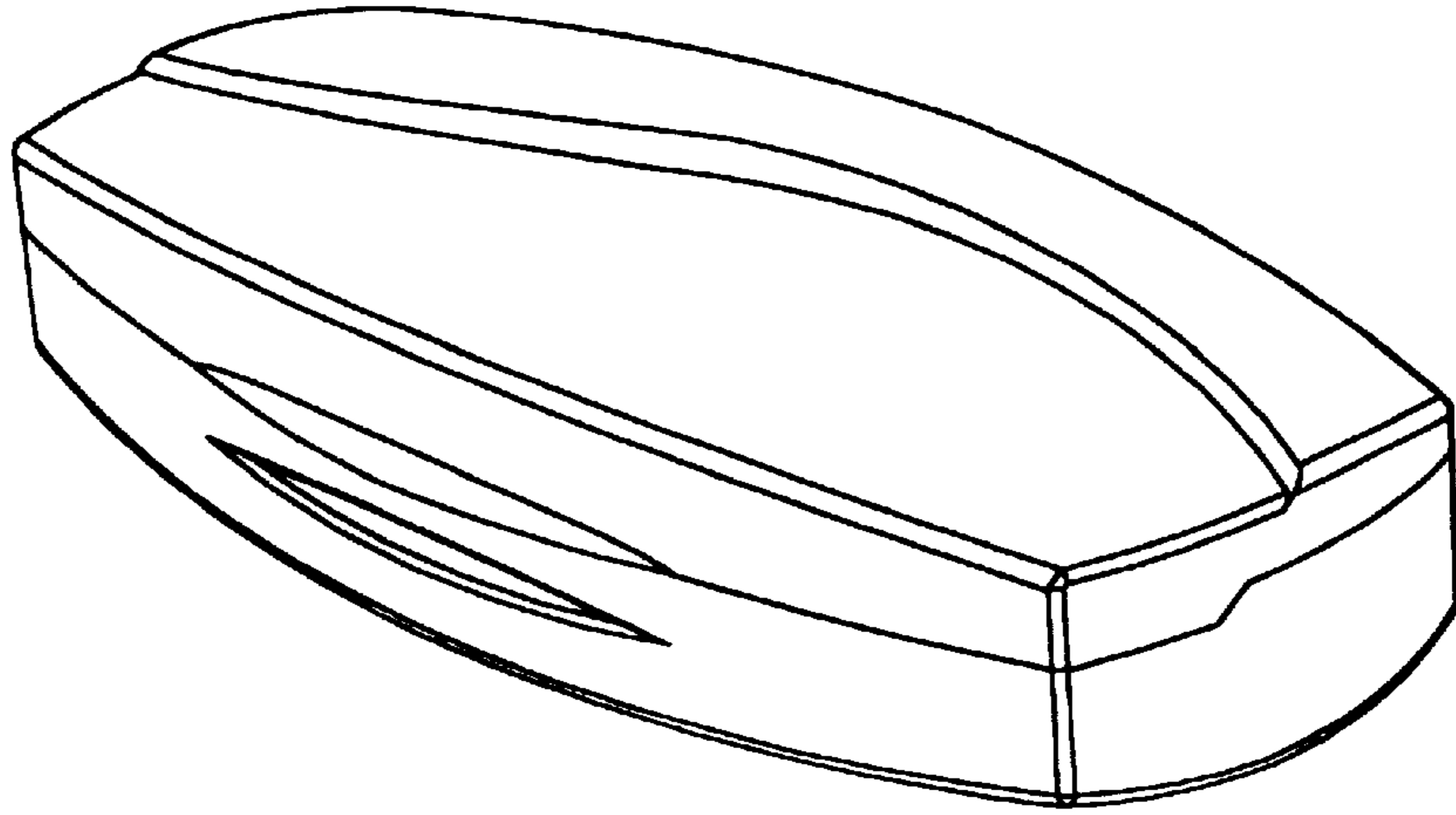

FIG. 5

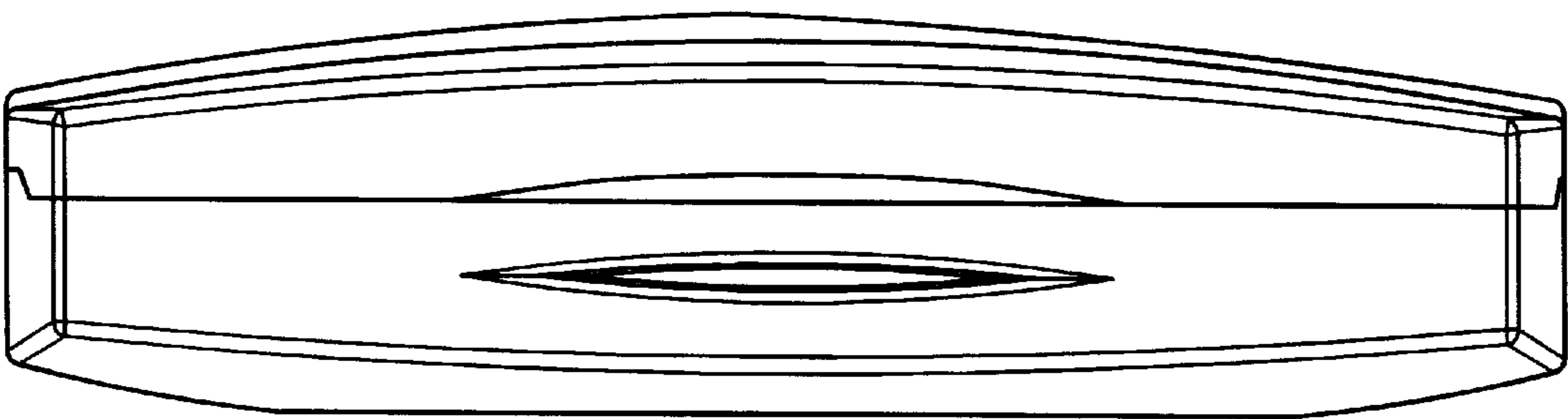

FIG. 6

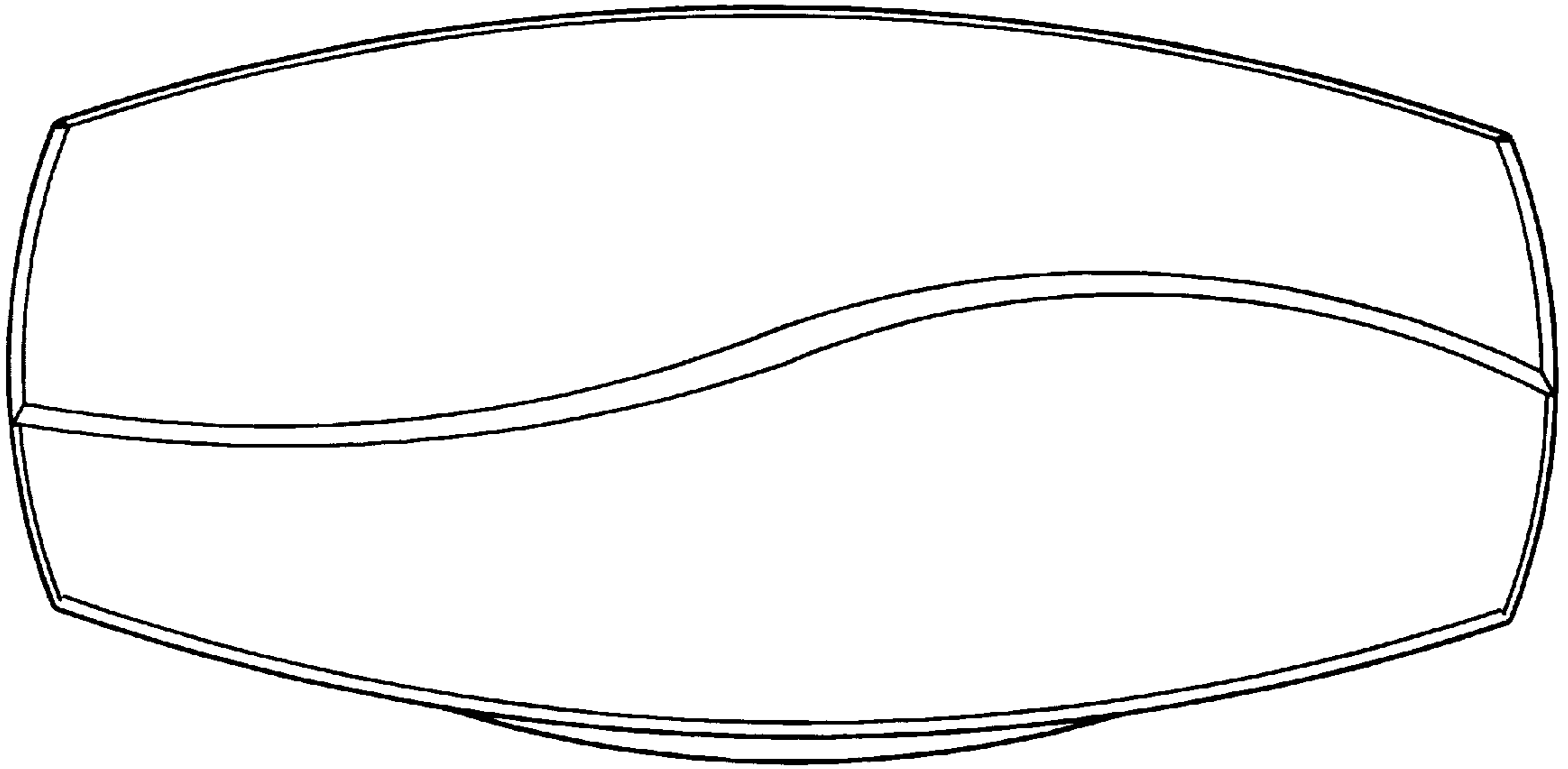

FIG. 7

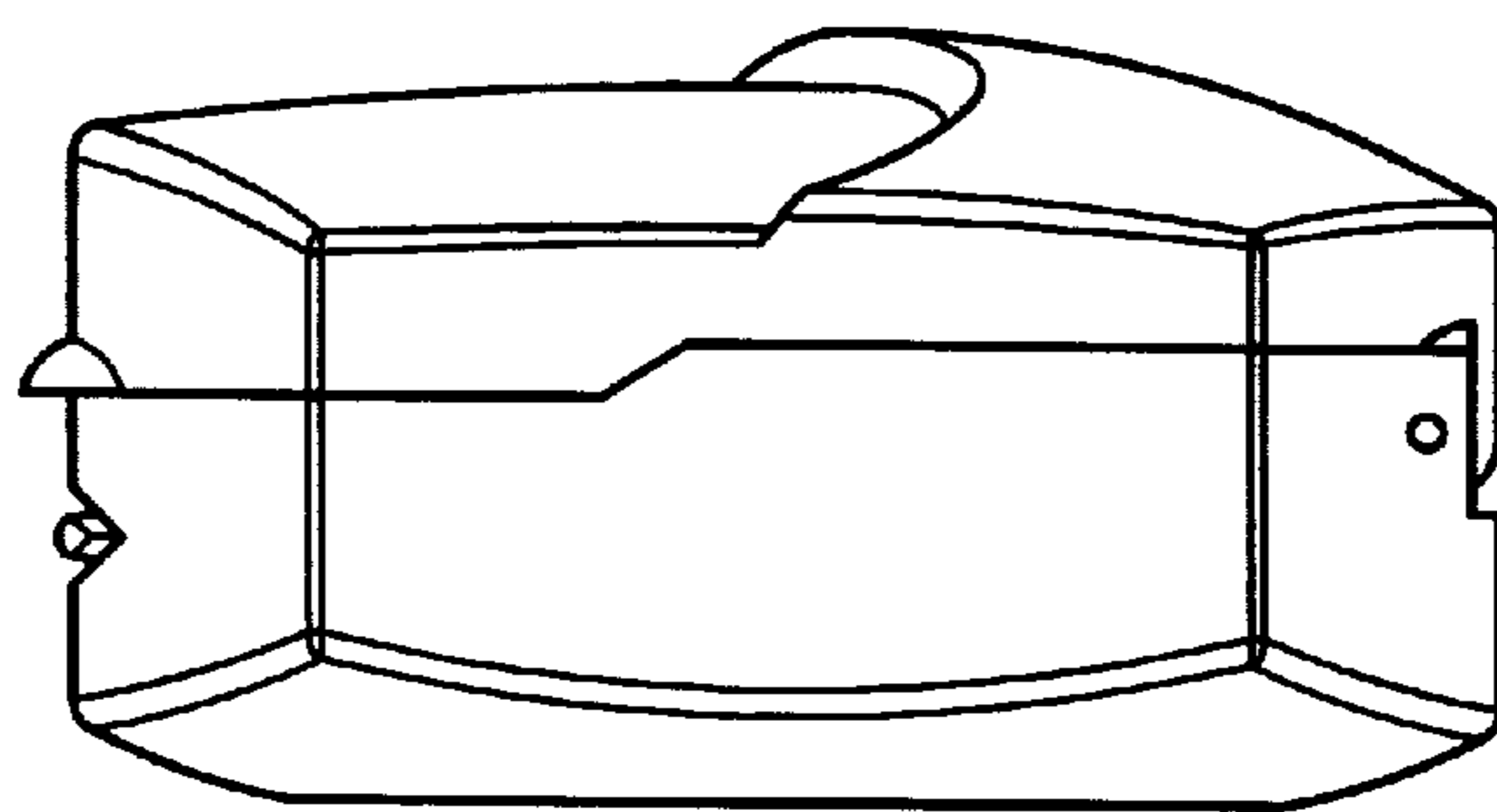

FIG. 8