



US00D443514S

(12) **United States Design Patent**
Lin

(10) **Patent No.:** **US D443,514 S**

(45) **Date of Patent:** **** Jun. 12, 2001**

(54) **COMBINED COSMETIC JAR AND CAP**

(76) Inventor: **Yi-Hung Lin**, No. 101, Hsi-Chou Rd.,
Tai-Ping City, Taichung Hsien (TW)

(**) Term: **14 Years**

(21) Appl. No.: **29/118,548**

(22) Filed: **Feb. 11, 2000**

(51) **LOC (7) Cl.** **09-01**

(52) **U.S. Cl.** **D9/504; D9/520; D28/76**

(58) **Field of Search** D28/76, 77, 82,
D28/91; D9/503, 504, 519, 520, 549, 529,
553, 559, 566, 414, 418; 132/286, 293;
206/581, 823; 215/329, 379, 382, 383;
220/376, 377

(56) **References Cited**

U.S. PATENT DOCUMENTS

D. 226,521	*	3/1973	Lerner	D9/529
D. 255,215	*	6/1980	Ellinwood	D9/540
D. 391,162	*	2/1998	Kokenge	D9/504
D. 392,889	*	3/1998	Liu	D9/504
D. 408,285	*	4/1999	Favre	D9/503
5,064,082	*	11/1991	Lombardi et al.	220/377 X
5,975,321	*	11/1999	Luch	215/329 X

* cited by examiner

Primary Examiner—Ted Shooman

Assistant Examiner—C. Tuttle

(74) *Attorney, Agent, or Firm*—Pepper Hamilton LLP

(57) **CLAIM**

The ornamental design for a combined cosmetic jar and cap,
as shown and described.

DESCRIPTION

This application is related to Taiwanese Design Application
No. 88308313 filed Dec. 18, 1999.

1 Claim, 5 Drawing Sheets

FIG. 1 is a perspective view of a combined cosmetic jar and
cap showing my new design;

FIG. 2 is a front elevational view of FIG. 1;

FIG. 3 is a rear elevational view of FIG. 1;

FIG. 4 is a top plan view of FIG. 1;

FIG. 5 is a bottom view of FIG. 1;

FIG. 6 is a perspective view of the cap separated from the
body of the jar in FIG. 1;

FIG. 7 is a front elevational view of the cap of the jar in FIG.
1;

FIG. 8 is a rear elevational view of the cap of the jar in FIG.
1;

FIG. 9 is a top plan view of the cap of the jar in FIG. 1;

FIG. 10 is a bottom view of the cap of the jar in FIG. 1;

FIG. 11 is a cross-section view of the cap of the jar in FIG.
1;

FIG. 12 is a front elevational view of the body of the jar in
FIG. 1;

FIG. 13 is a rear elevational view of the body of the jar in
FIG. 1;

FIG. 14 is a top plan view of the body of the jar in FIG. 1;
and,

FIG. 15 is a bottom view of the body of the jar in FIG. 1.

The cap in FIGS. 7 through 11 and the jar in FIGS. 12
through 15 are shown separately for clarity of illustration.

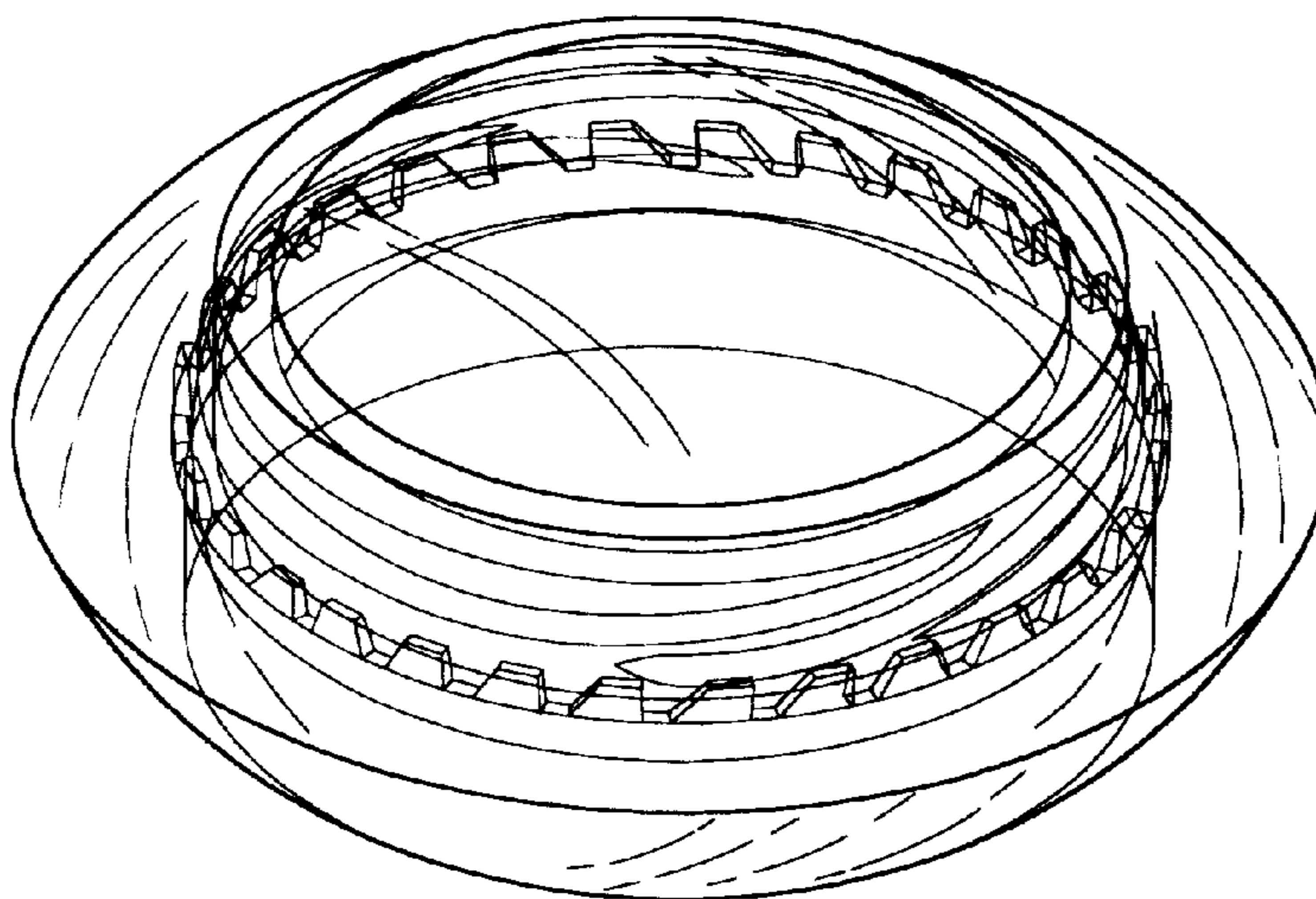

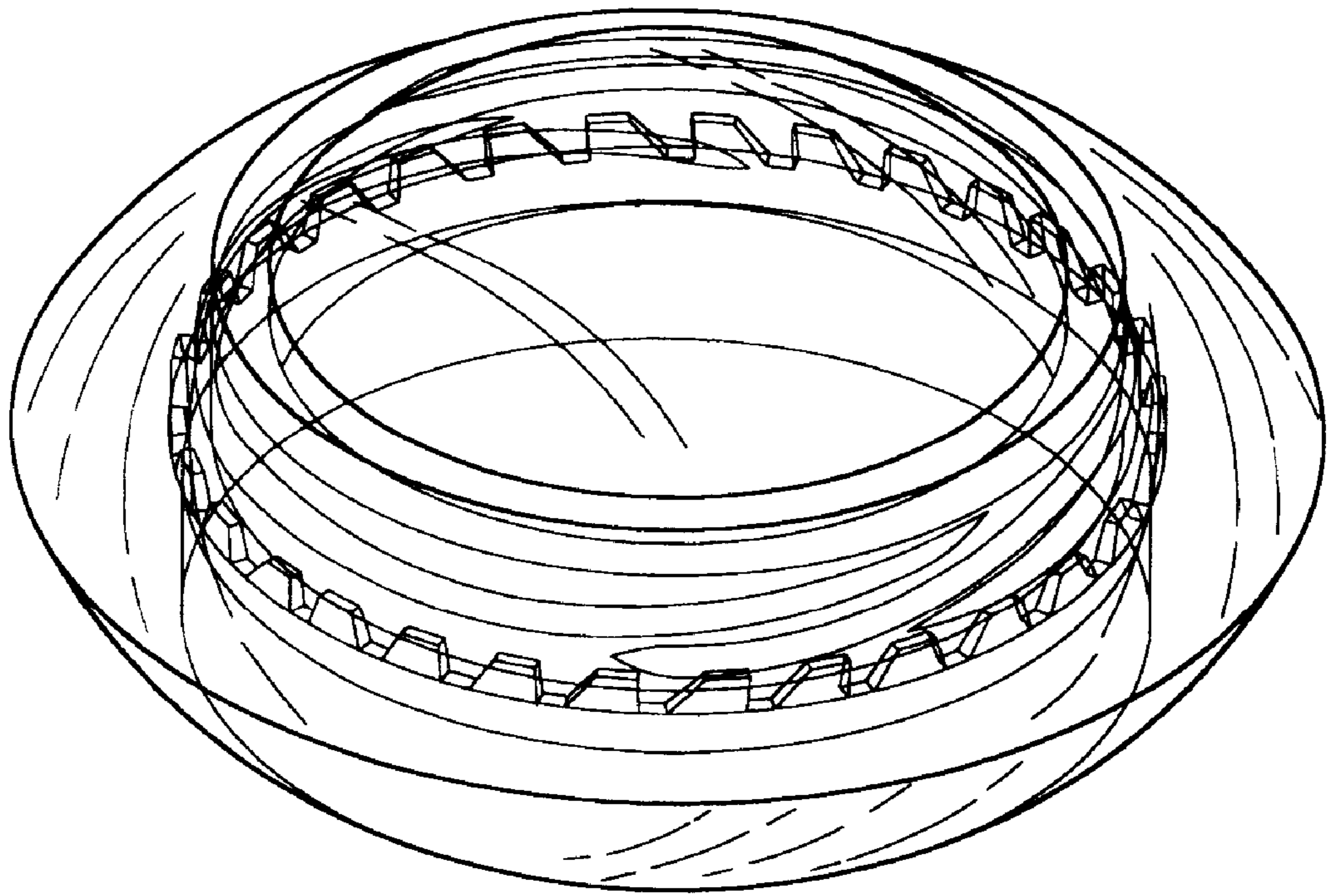

FIG. 1

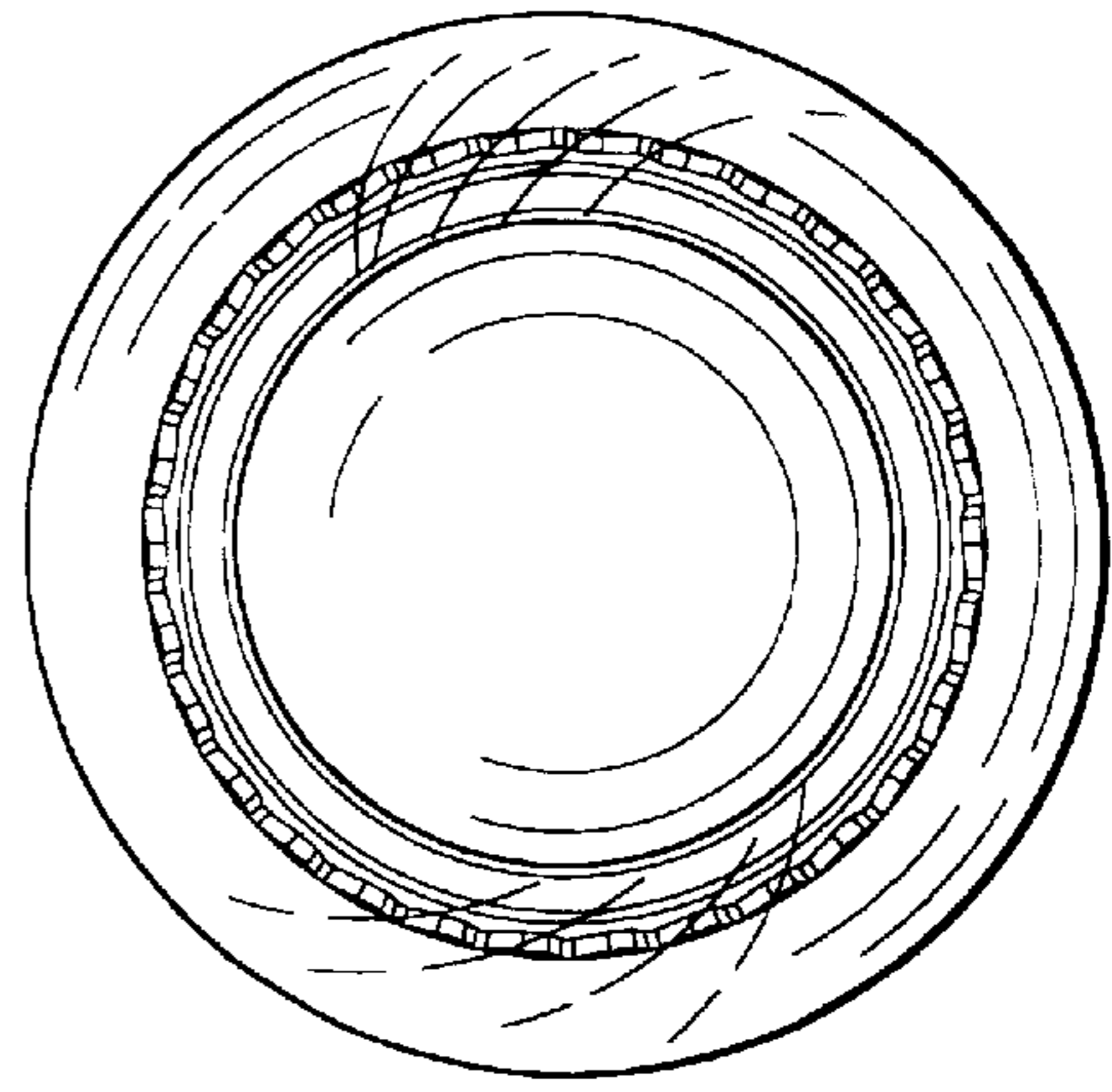

FIG. 4

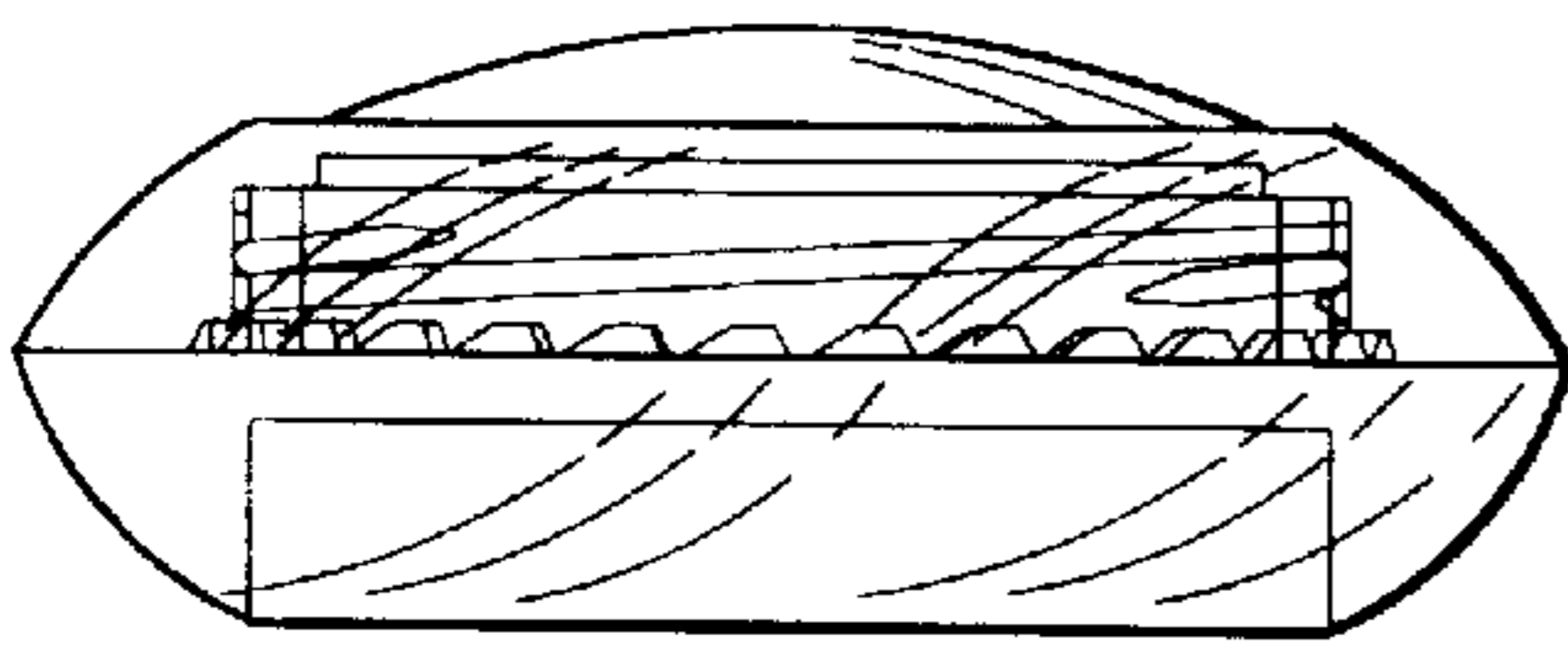

FIG. 3

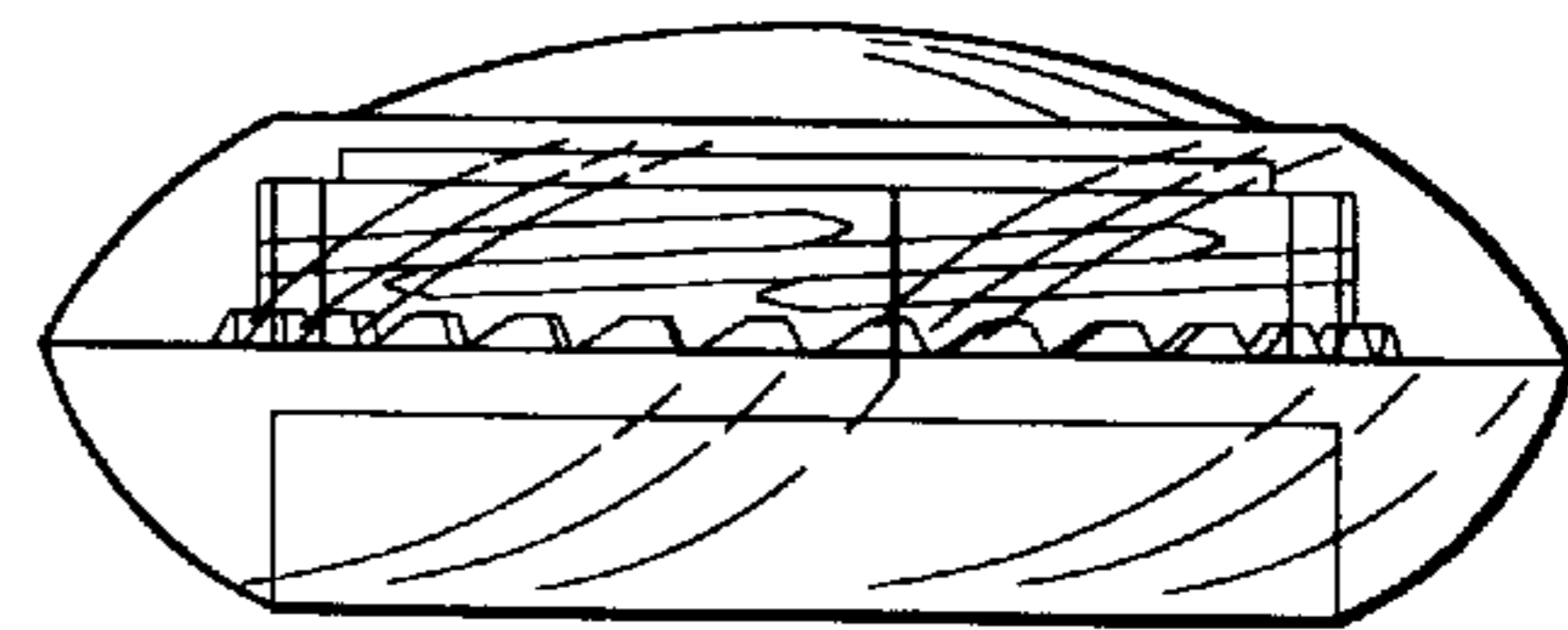

FIG. 2

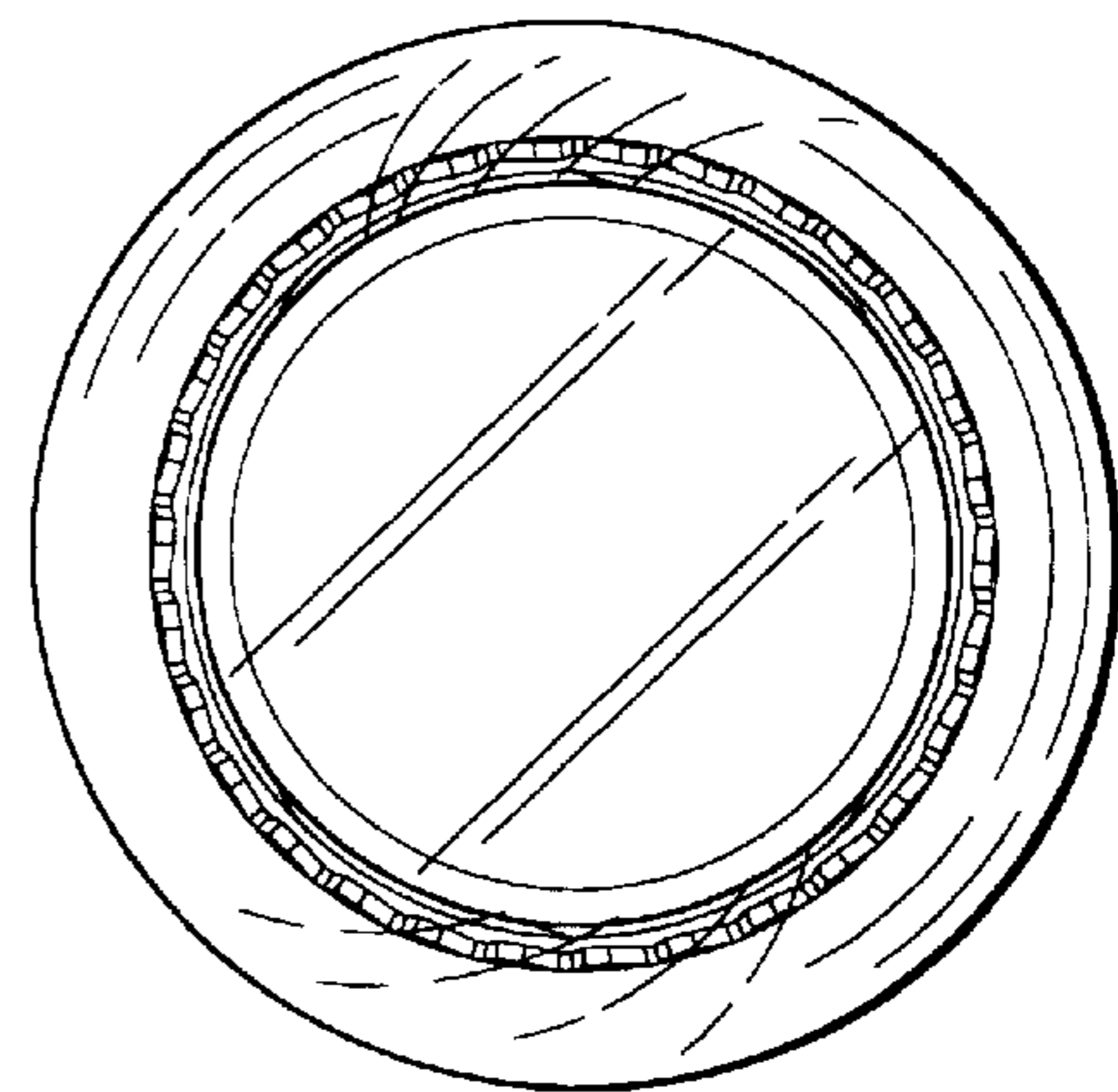

FIG. 5

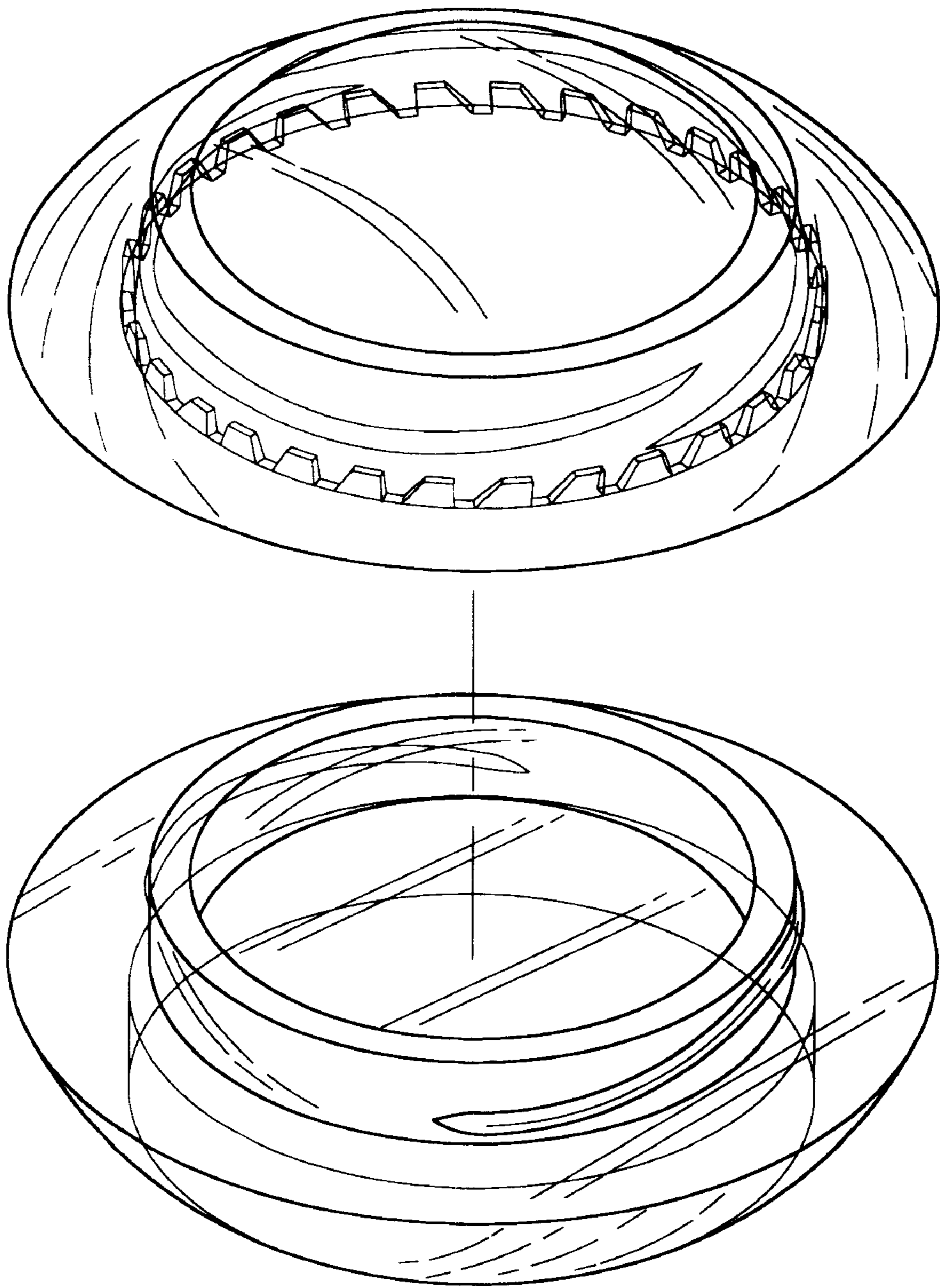

FIG. 6

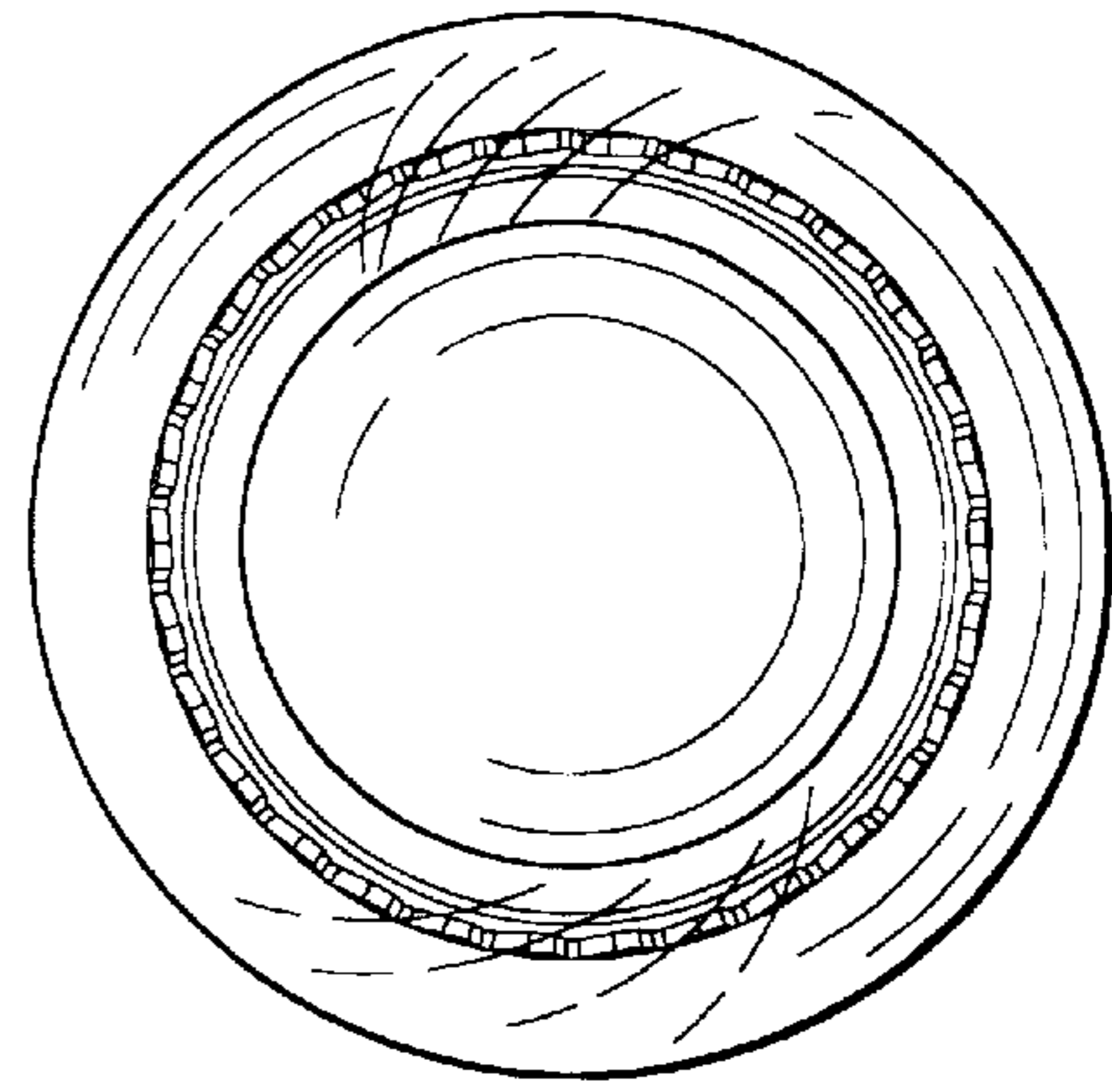

FIG. 9



FIG. 8



FIG. 7

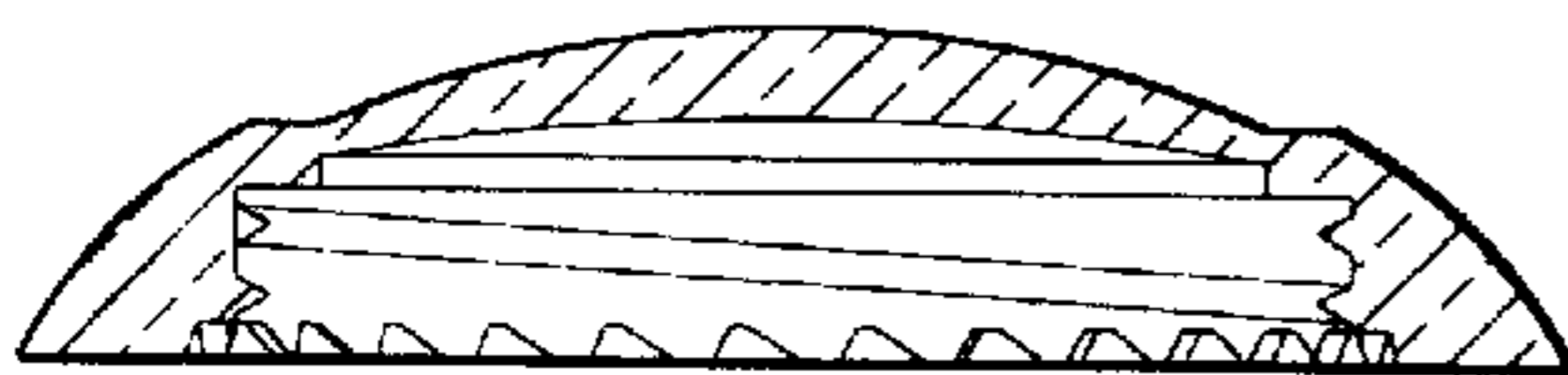

FIG. 11

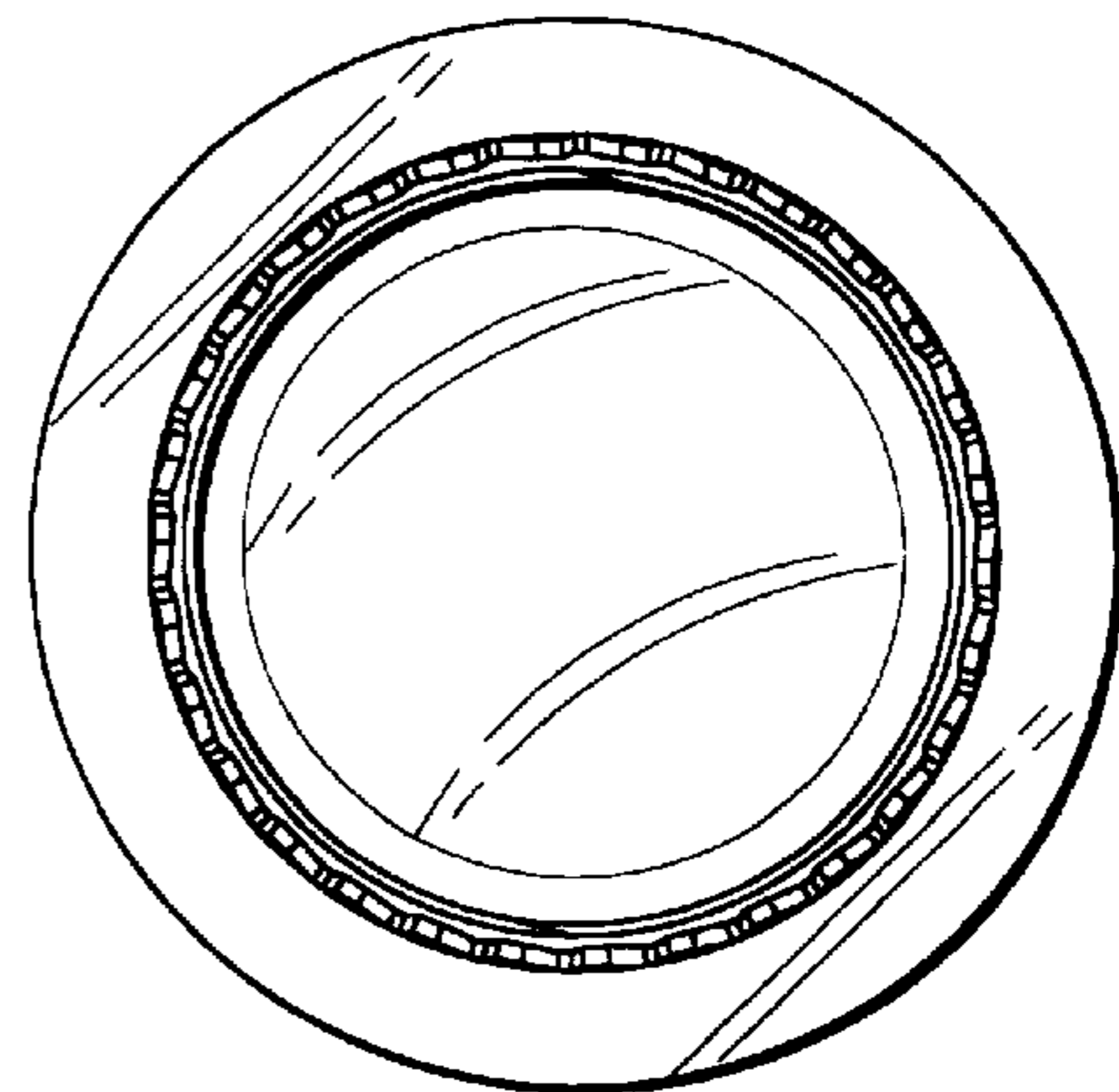

FIG. 10

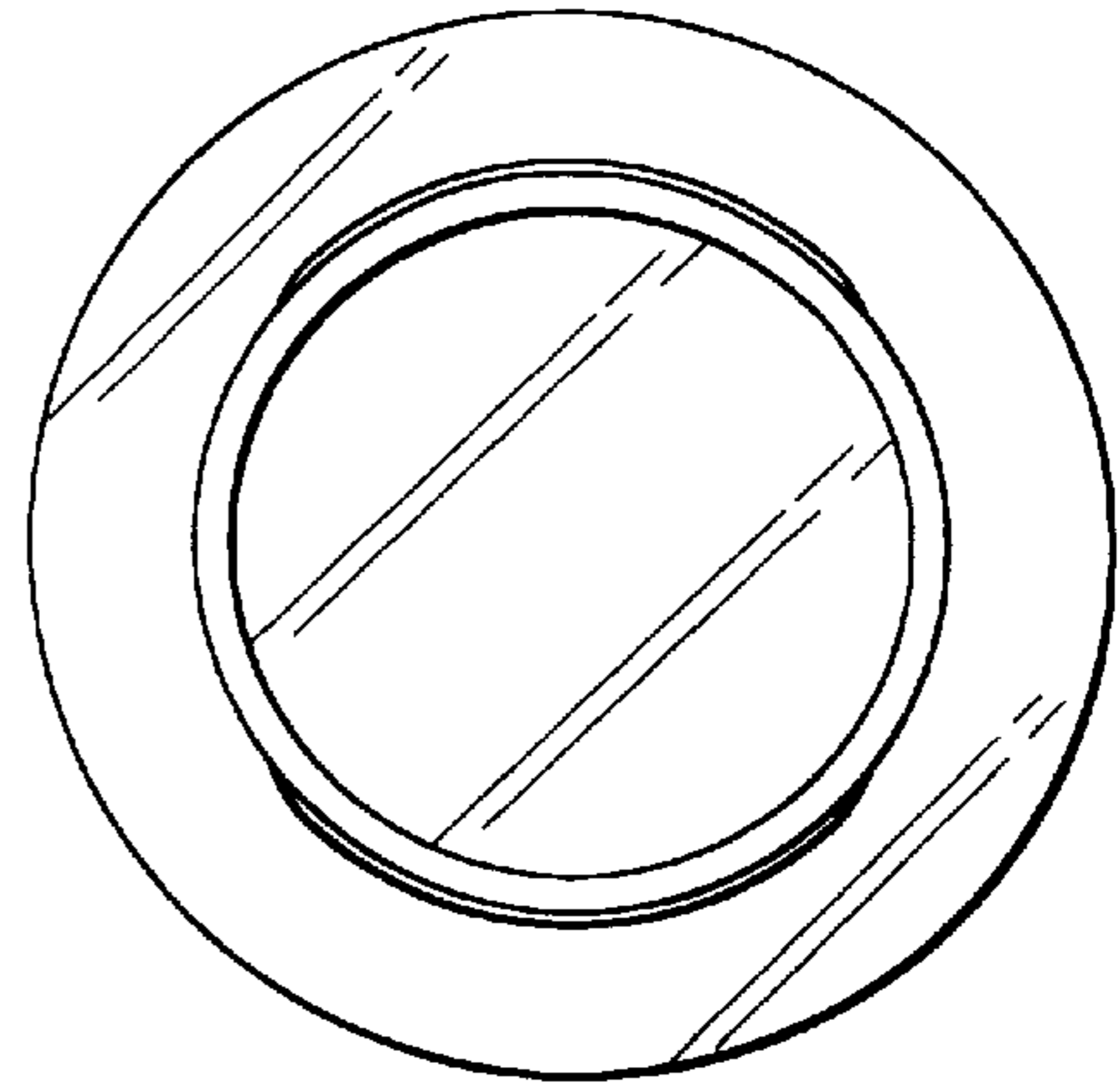

FIG. 14

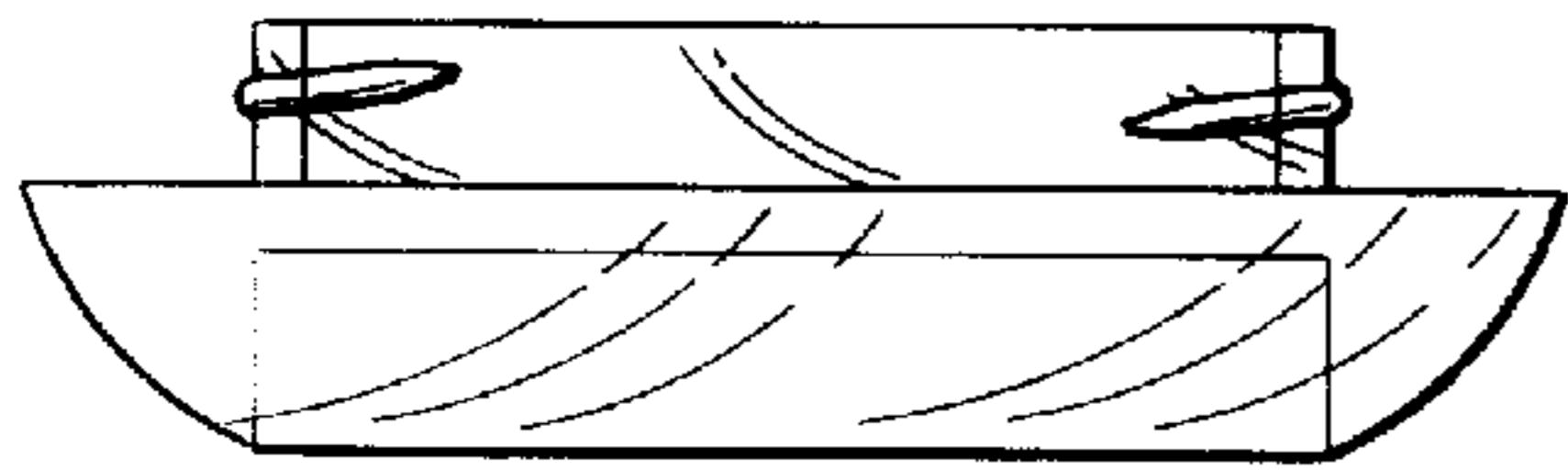

FIG. 13

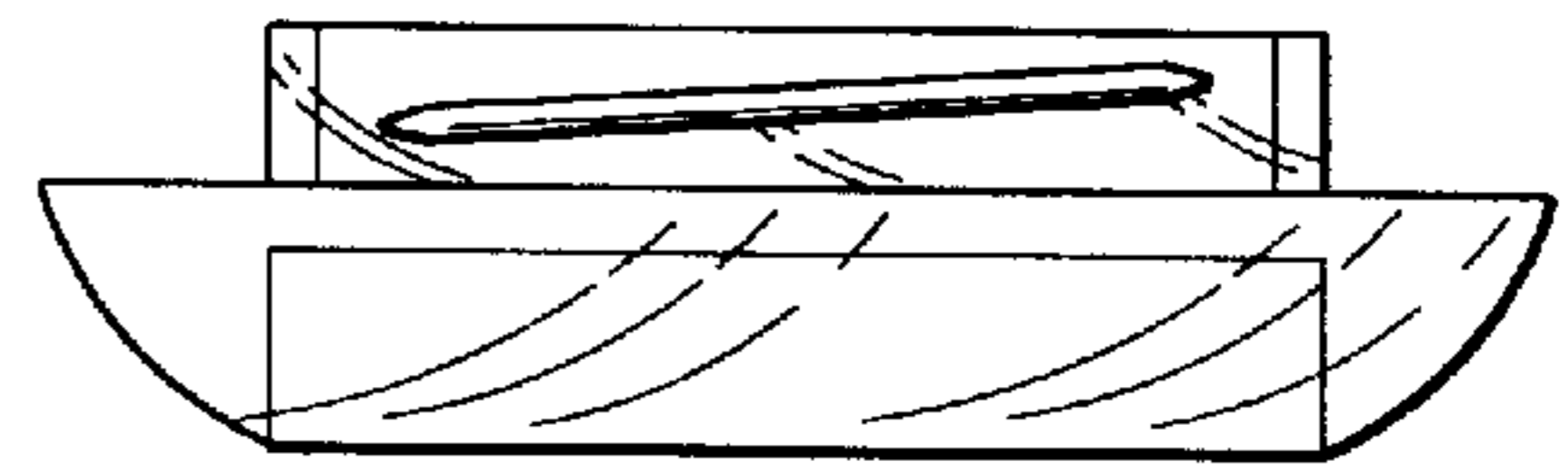

FIG. 12

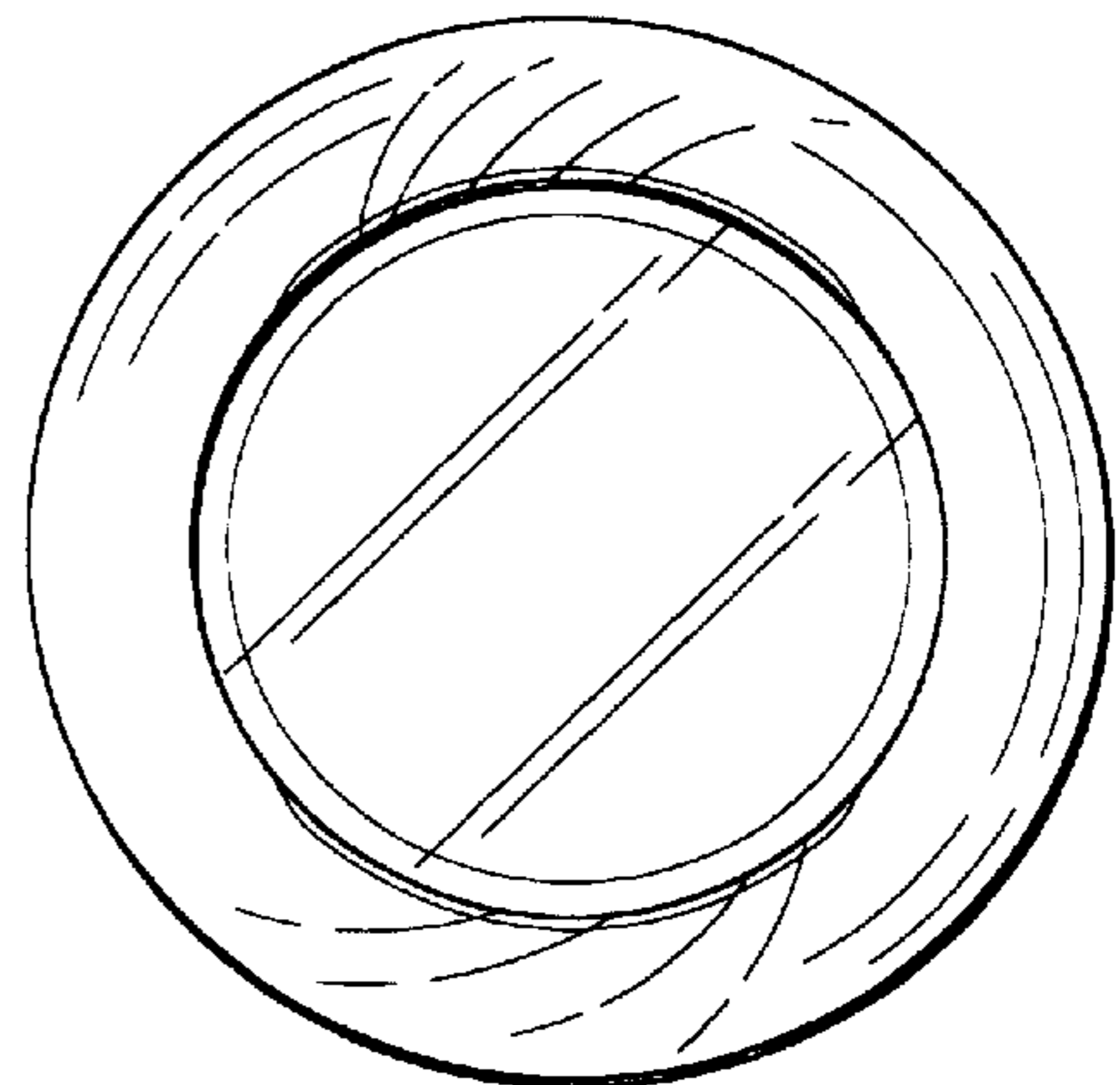

FIG. 15