



US00D443477S

(12) **United States Design Patent**
Miura

(10) **Patent No.:** **US D443,477 S**

(45) **Date of Patent:** **** Jun. 12, 2001**

(54) **CUP FOR BEVERAGES OR FOOD**

(75) Inventor: **Masami Miura**, Tokyo (JP)

(73) Assignee: **San-ai Corporation**, Tokyo (JP)

(**) Term: **14 Years**

(21) Appl. No.: **29/121,089**

(22) Filed: **Apr. 3, 2000**

(30) **Foreign Application Priority Data**

Jan. 26, 2000 (JP) 12-000967

(51) **LOC (7) Cl.** **07-01**

(52) **U.S. Cl.** **D7/507; D7/536**

(58) **Field of Search** D7/507, 50, 533,
D7/536, 523, 534; 229/4, 1.5 B, 393, 400,
401, 402; 220/703, 713, 675, 719, 710.5,
612; 248/146; 206/579, 459, 514; 215/383,
391; 428/36.4; 493/88

(56) **References Cited**

U.S. PATENT DOCUMENTS

| | | | | | |
|------------|---|---------|----------------|-------|---------|
| D. 129,823 | * | 10/1941 | Reiber | | D7/534 |
| 2,060,781 | * | 11/1936 | Annen | | 229/402 |
| 2,287,644 | * | 6/1942 | Schacht | | 229/4.5 |
| 2,378,750 | * | 6/1945 | Carew | | 229/402 |
| 2,558,287 | * | 6/1951 | Amberg | | 229/402 |
| 2,560,927 | * | 7/1951 | Buttery et al. | | 229/4.5 |
| 2,745,586 | * | 5/1956 | Thoma | | 229/401 |
| 2,775,382 | * | 12/1956 | Kayat | | 229/402 |
| 2,867,365 | * | 1/1959 | Tourette | | 229/401 |
| 2,988,967 | * | 6/1961 | Dudnick et al. | | 493/88 |
| 3,268,143 | * | 8/1966 | Bolgato | | 229/400 |
| 3,357,623 | * | 12/1967 | Wommelsdorf | | 229/404 |
| 3,926,361 | * | 12/1975 | Hilderbrand | | 229/402 |
| 4,102,454 | * | 7/1978 | Karevaara | | 206/514 |

| | | | | | |
|-----------|---|---------|-----------------|-------|-----------|
| 4,412,644 | * | 11/1983 | Fever | | 229/402 |
| 4,578,296 | * | 3/1986 | Miyazaki et al. | | 428/36.4 |
| 4,685,583 | * | 8/1987 | Noon | | 220/710.5 |
| 4,836,400 | * | 6/1989 | Chaffey et al. | | 220/612 |
| 5,996,887 | * | 12/1999 | Cai et al. | | 229/400 |
| 6,116,503 | * | 9/2000 | Varano | | 229/403 |

OTHER PUBLICATIONS

U.S. application No. 29/112,047, filed Oct. 7, 1999, pending.
U.S. application No. 29/117,596, filed Jan. 31, 2000, pending.

U.S. application No. 29/117,582, filed Jan. 31, 2000, pending.

U.S. application No. 29/121,090, filed Apr. 3, 2000, pending.

U.S. application No. 29/121,089, filed Apr. 3, 2000, pending.

* cited by examiner

Primary Examiner—M. N. Pandozzi

(74) *Attorney, Agent, or Firm*—Oblon, Spivak, McClelland, Maier & Neustadt, P.C.

(57) **CLAIM**

The ornamental design for a cup for beverages or food, as shown and described.

DESCRIPTION

FIG. 1 is a front elevational view of a cup for beverages or food, showing my new design;
FIG. 2 is a rear elevational view thereof;
FIG. 3 is a top plan view thereof;
FIG. 4 is a bottom plan view thereof;
FIG. 5 is a right side elevational view thereof; and,
FIG. 6 is an exploded top perspective view thereof; with the handle and stirring piece in an alternate position.

1 Claim, 3 Drawing Sheets

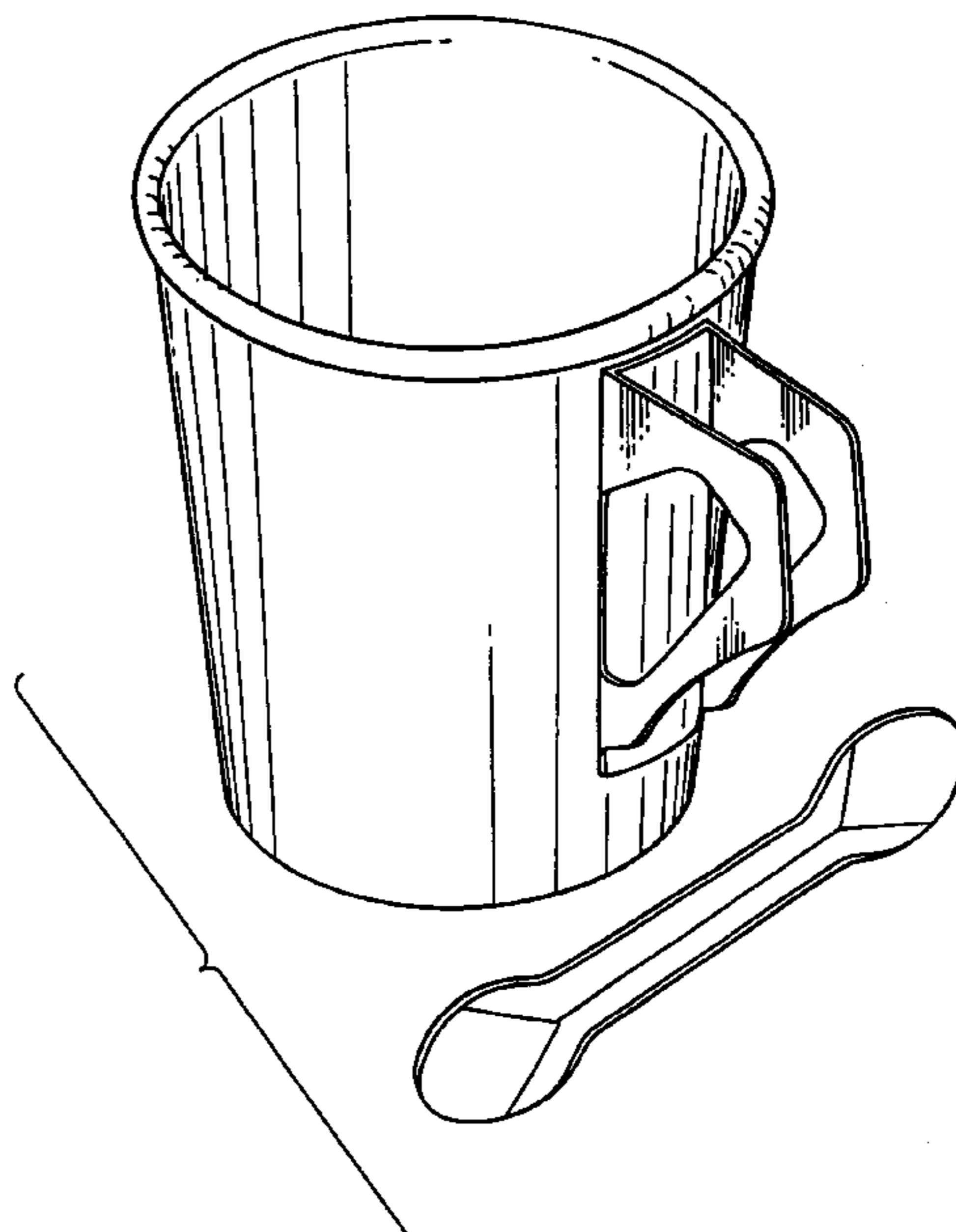
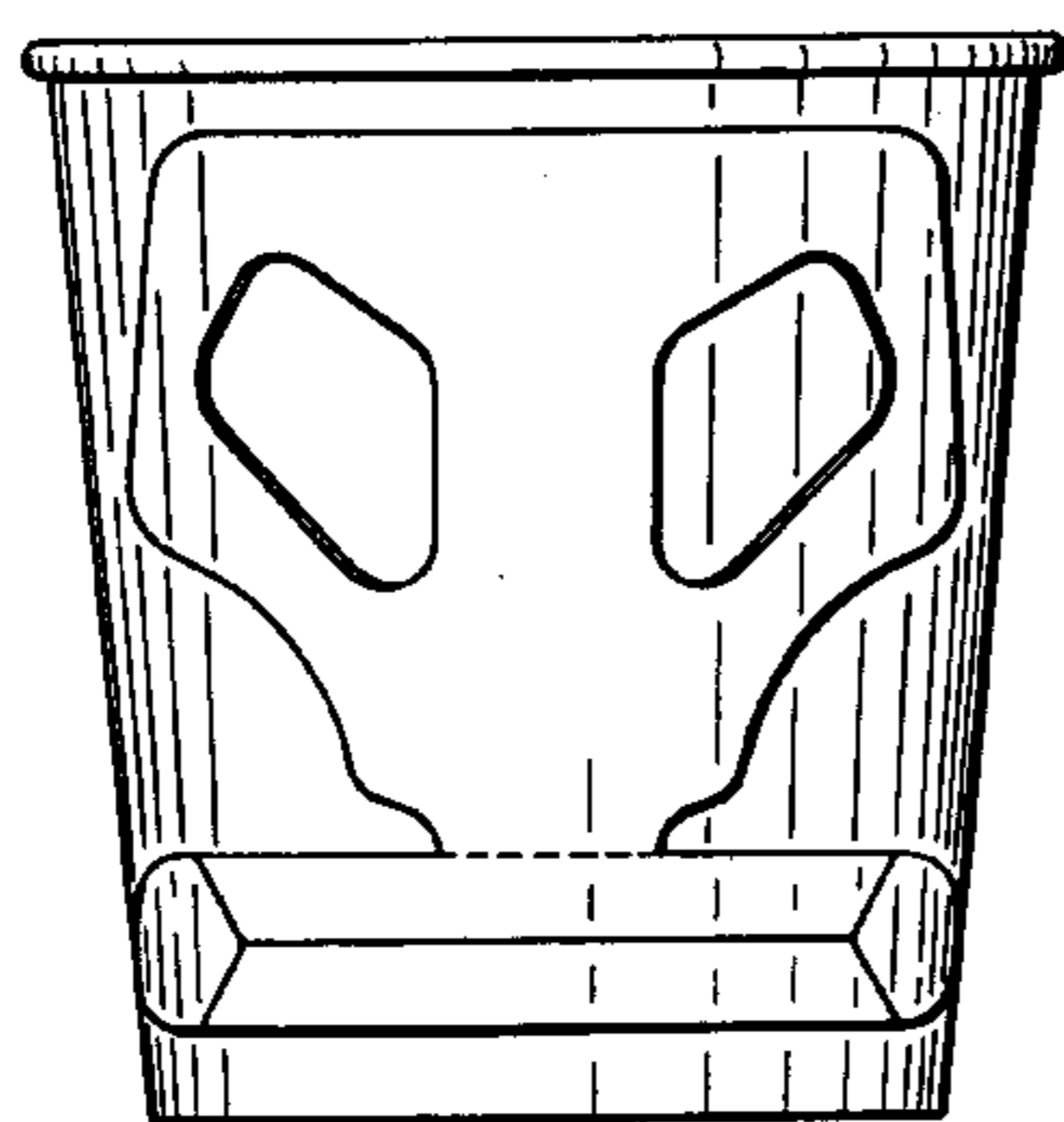

FIG. 1

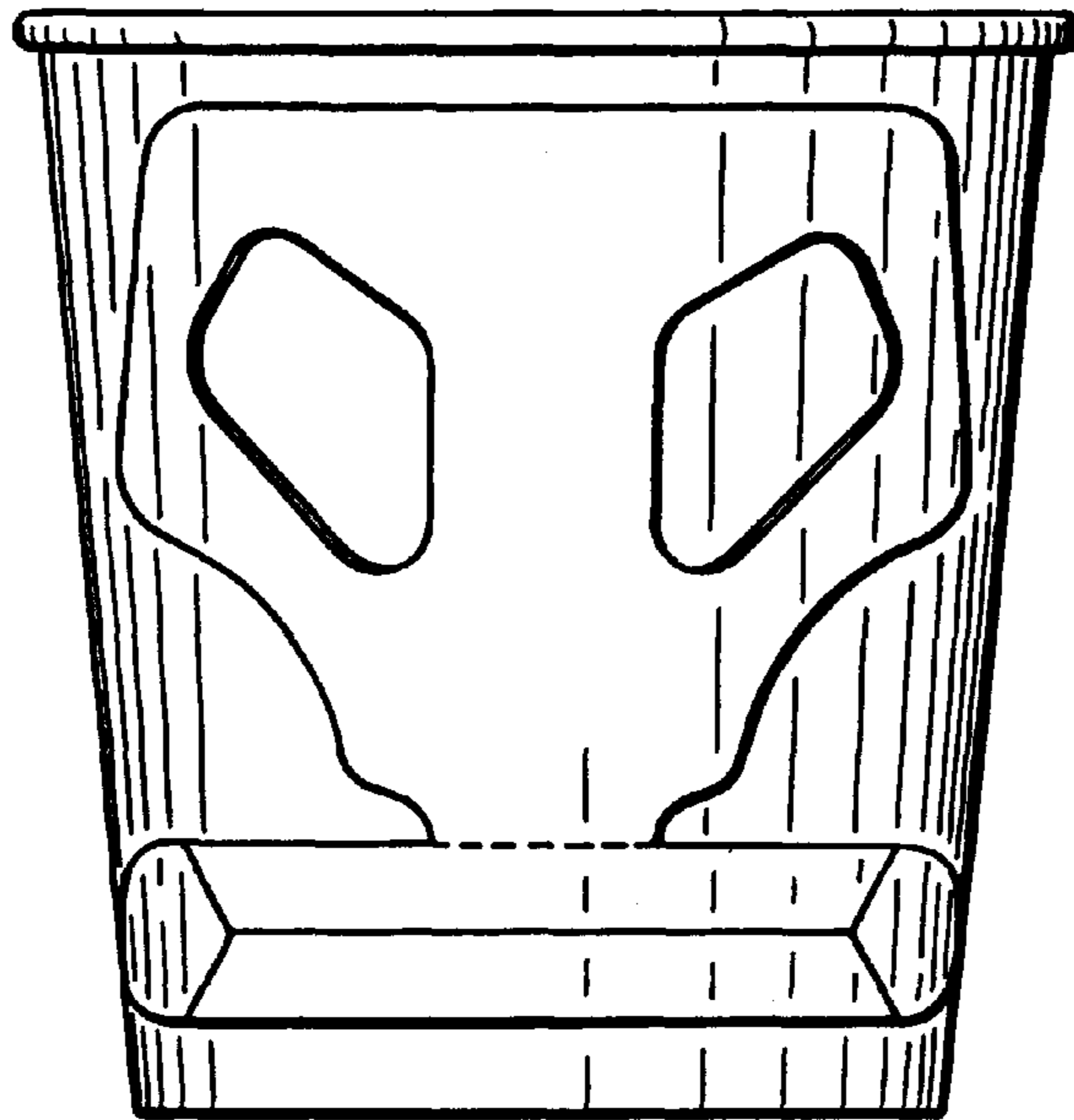

FIG. 2

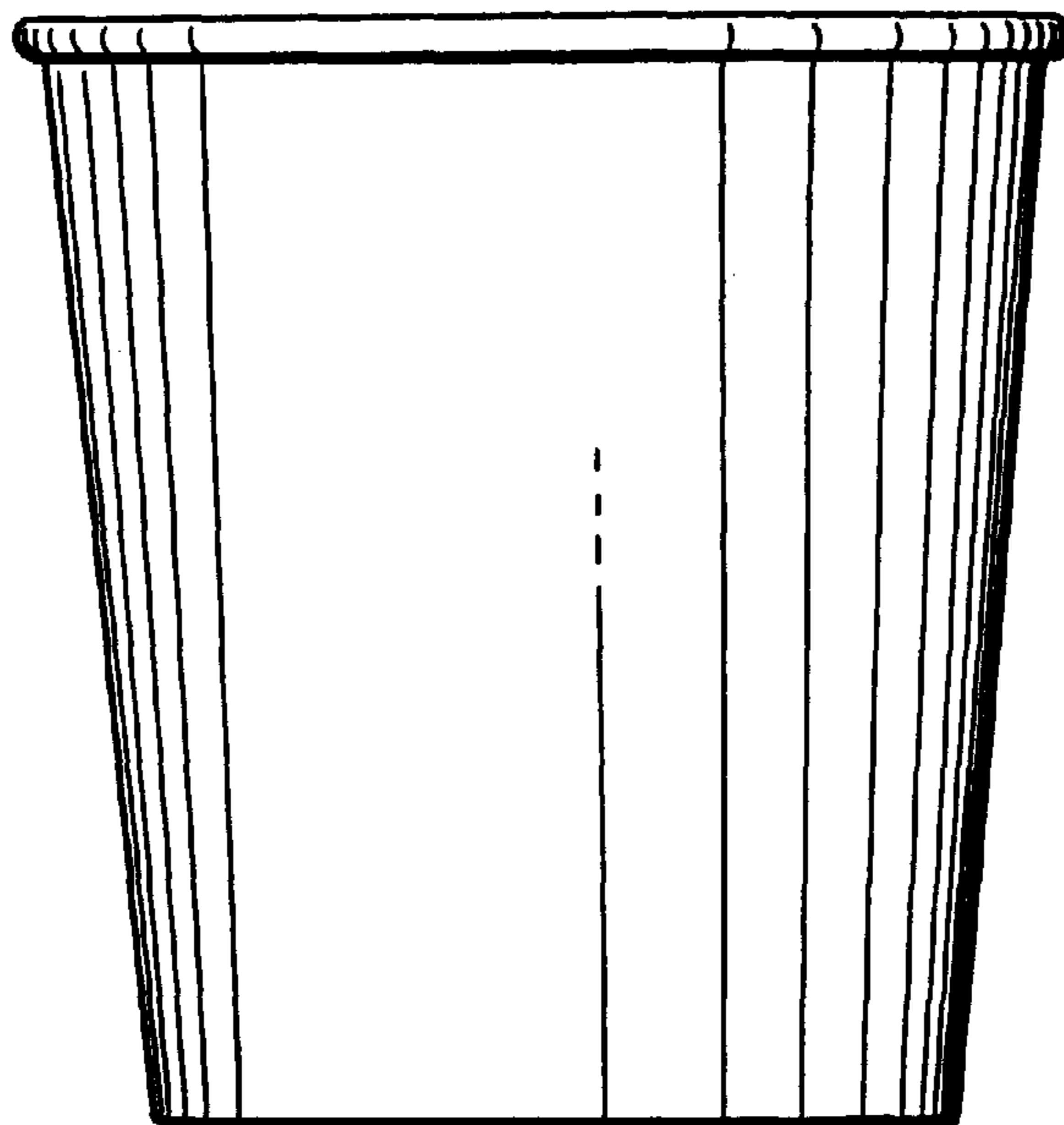

FIG. 3

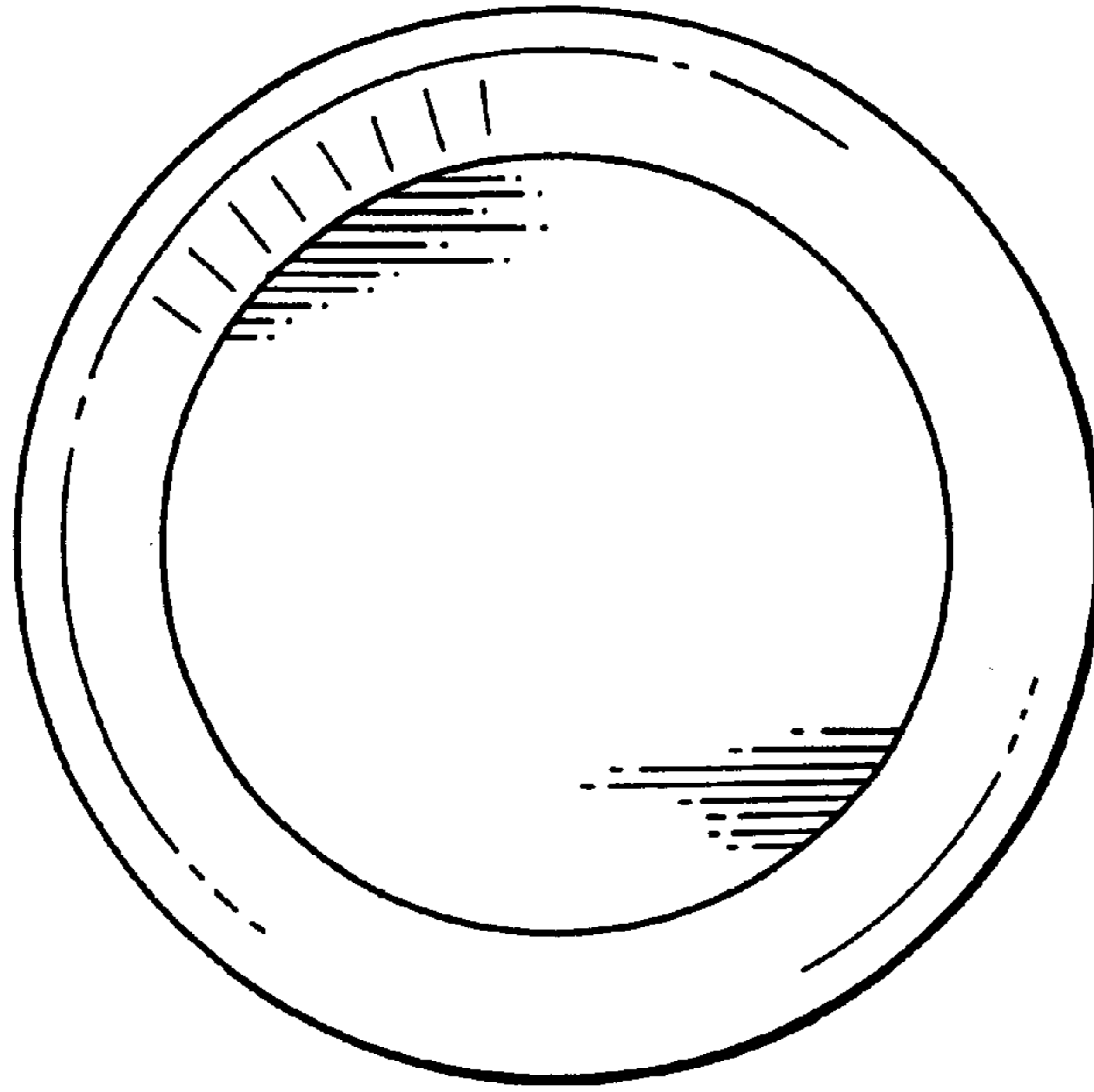

FIG. 4

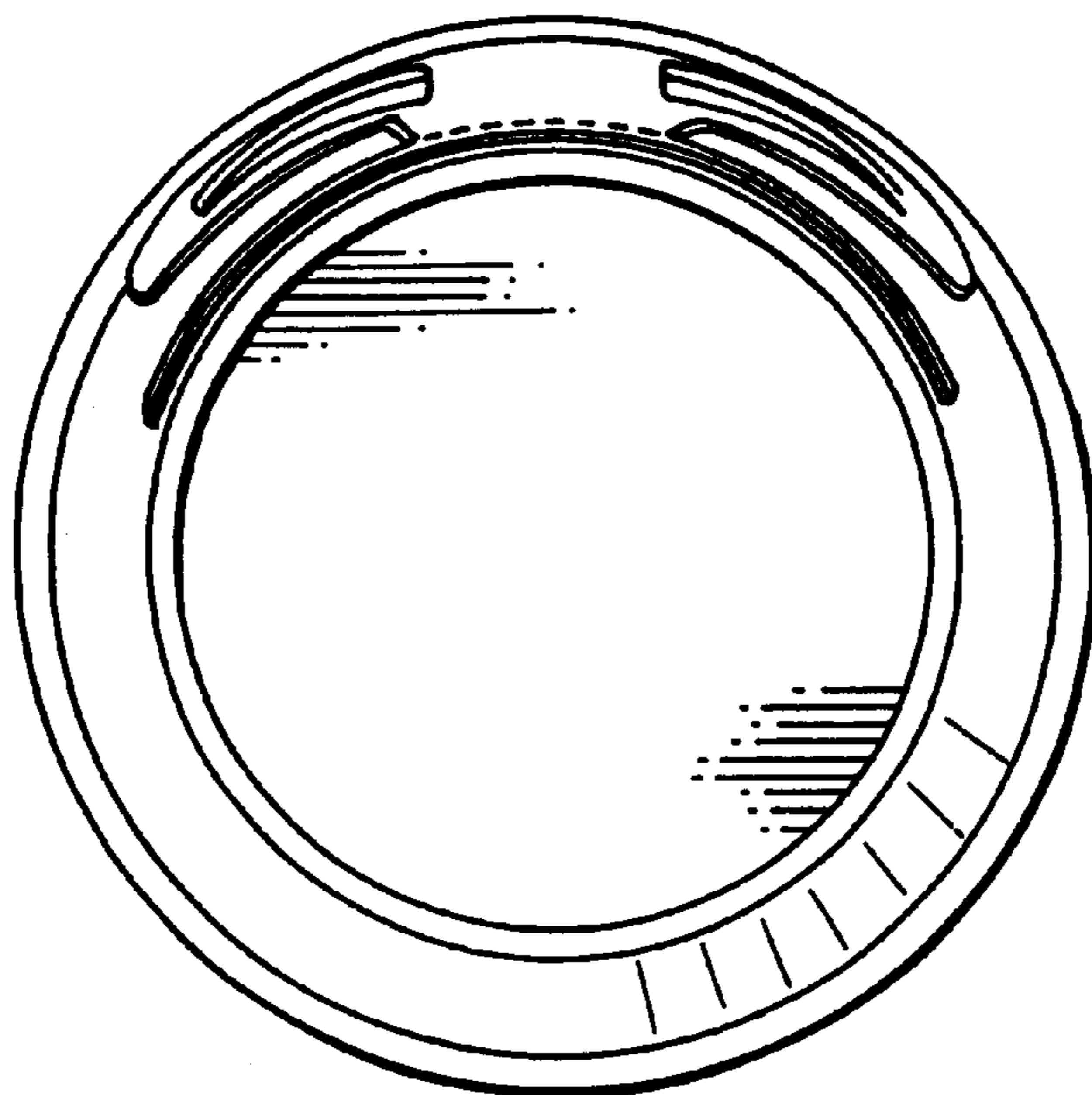

FIG. 5

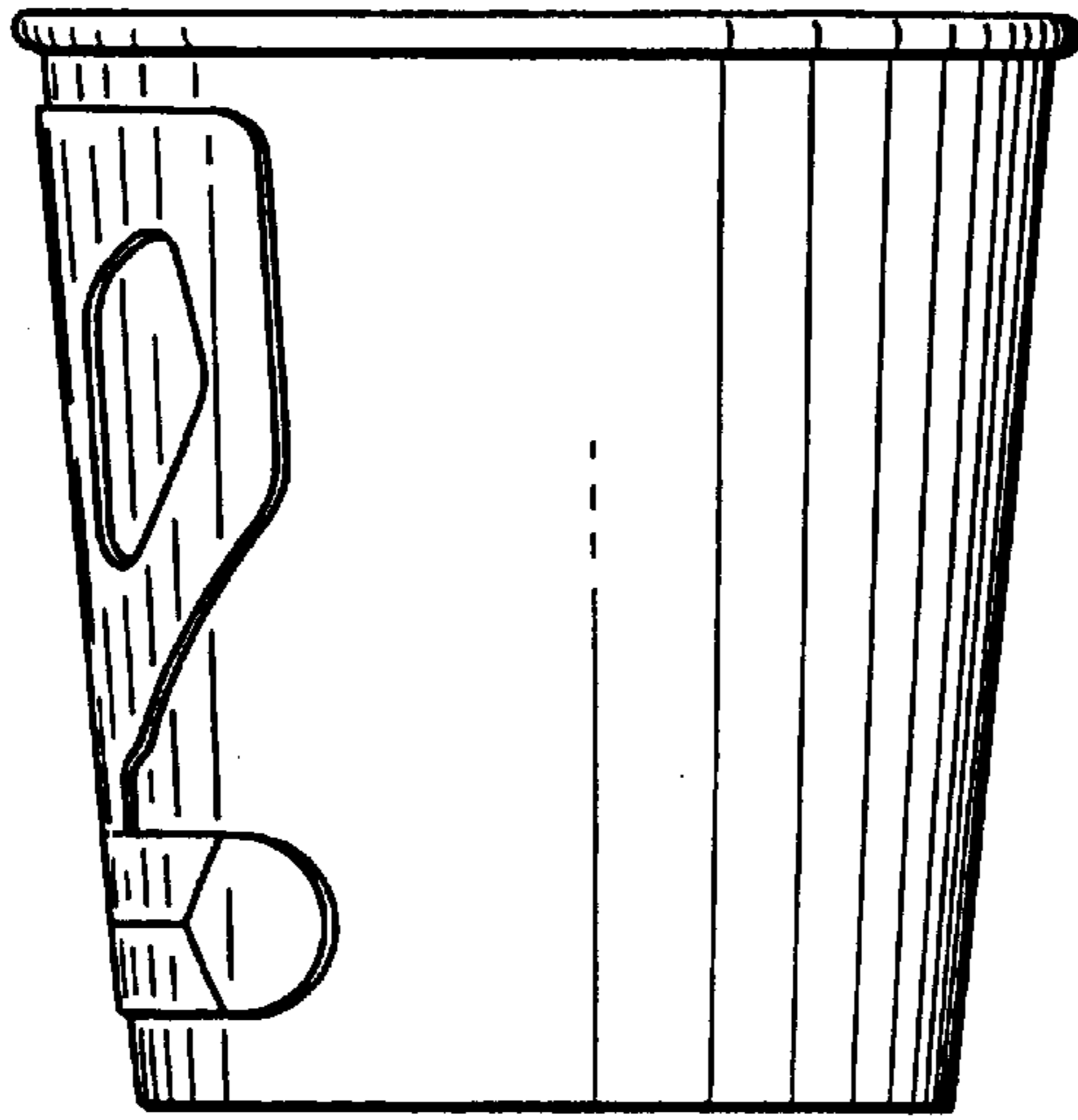

FIG. 6

