



US00D443440S

(12) **United States Design Patent**
Deimen et al.

(10) **Patent No.:** **US D443,440 S**
(45) **Date of Patent:** **** Jun. 12, 2001**

(54) **TABLE**

(75) Inventors: **Michael L. Deimen**, Burleson; **Robert L. Stewart**, Grapevine, both of TX (US); **Frank A. Friedman**, Mill Valley, CA (US); **David M. Webster**, San Francisco, CA (US); **Kristine R. Chan-Lizardo**, Palo Alto, CA (US); **James R. Yurchenco**, Palo Alto, CA (US); **Annetta M. Papadopoulos**, Palo Alto, CA (US); **Diego A. Rodriguez**, Boulder, CO (US)

(73) Assignee: **Steelcase Development Inc.**, Caledonia, MI (US)

(**) Term: **14 Years**

(21) Appl. No.: **29/131,601**

(22) Filed: **Oct. 25, 2000**

Related U.S. Application Data

(62) Division of application No. 29/117,717, filed on Jan. 31, 2000.

(51) **LOC (7) Cl.** **06-03**

(52) **U.S. Cl.** **D6/480**

(58) **Field of Search** D6/480-489, 495-499; 108/151, 153.1, 156, 157.1, 161; 248/188, 188.1

(56) **References Cited**

U.S. PATENT DOCUMENTS

- D. 301,666 * 6/1989 Greutmann et al. D6/480
- D. 325,833 5/1992 Saotome .
- D. 330,299 10/1992 Saotome .
- D. 336,393 * 6/1993 Saotome D6/484
- D. 336,394 * 6/1993 Ball D6/487
- D. 352,845 11/1994 Hellwig et al. .
- D. 366,791 2/1996 Grosfillex .
- D. 399,685 10/1998 Grosfillex .

- 2,836,475 5/1958 Sapp .
- 3,115,850 12/1963 Sloan .
- 3,166,029 1/1965 Acton .
- 3,309,100 3/1967 Barbuti .
- 3,640,228 2/1972 Busse .
- 3,742,869 7/1973 Polsky et al. .
- 3,796,169 3/1974 Bales et al. .
- 4,248,161 * 2/1981 Adair et al. 108/6
- 4,372,631 2/1983 Leon .
- 4,748,913 6/1988 Favaretto et al. .
- 4,879,954 11/1989 Sawamura et al. .
- 4,986,195 1/1991 Diffrient .
- 5,205,223 4/1993 Ball et al. .
- 5,337,657 8/1994 Diffrient .
- 5,606,920 3/1997 Meyer et al. .
- 5,622,119 4/1997 Hsieh .
- 5,640,912 6/1997 Diffrient .
- 5,746,660 5/1998 Grover .
- 5,794,545 8/1998 McDaniel et al. .
- 5,878,673 3/1999 Kramer et al. .
- 5,906,420 5/1999 Rozier, Jr. et al. .
- 5,927,214 7/1999 Schwartz et al. .
- 5,934,201 8/1999 Diffrient .
- 5,934,203 8/1999 Glass .

* cited by examiner

Primary Examiner—Janice E. Seeger

(74) *Attorney, Agent, or Firm*—Price Heneveld Cooper DeWitt & Litton

(57) **CLAIM**

The ornamental design for a table, as shown and described.

DESCRIPTION

FIG. 1 is a perspective view of our table design; FIG. 2 is a left side view of FIG. 1; FIG. 3 is a top view of FIG. 1; FIG. 4 is a right side view of FIG. 1; FIG. 5 is a rear view of FIG. 1; FIG. 6 is a bottom view of FIG. 1; and, FIG. 7 is a front view of FIG. 1.

1 Claim, 4 Drawing Sheets

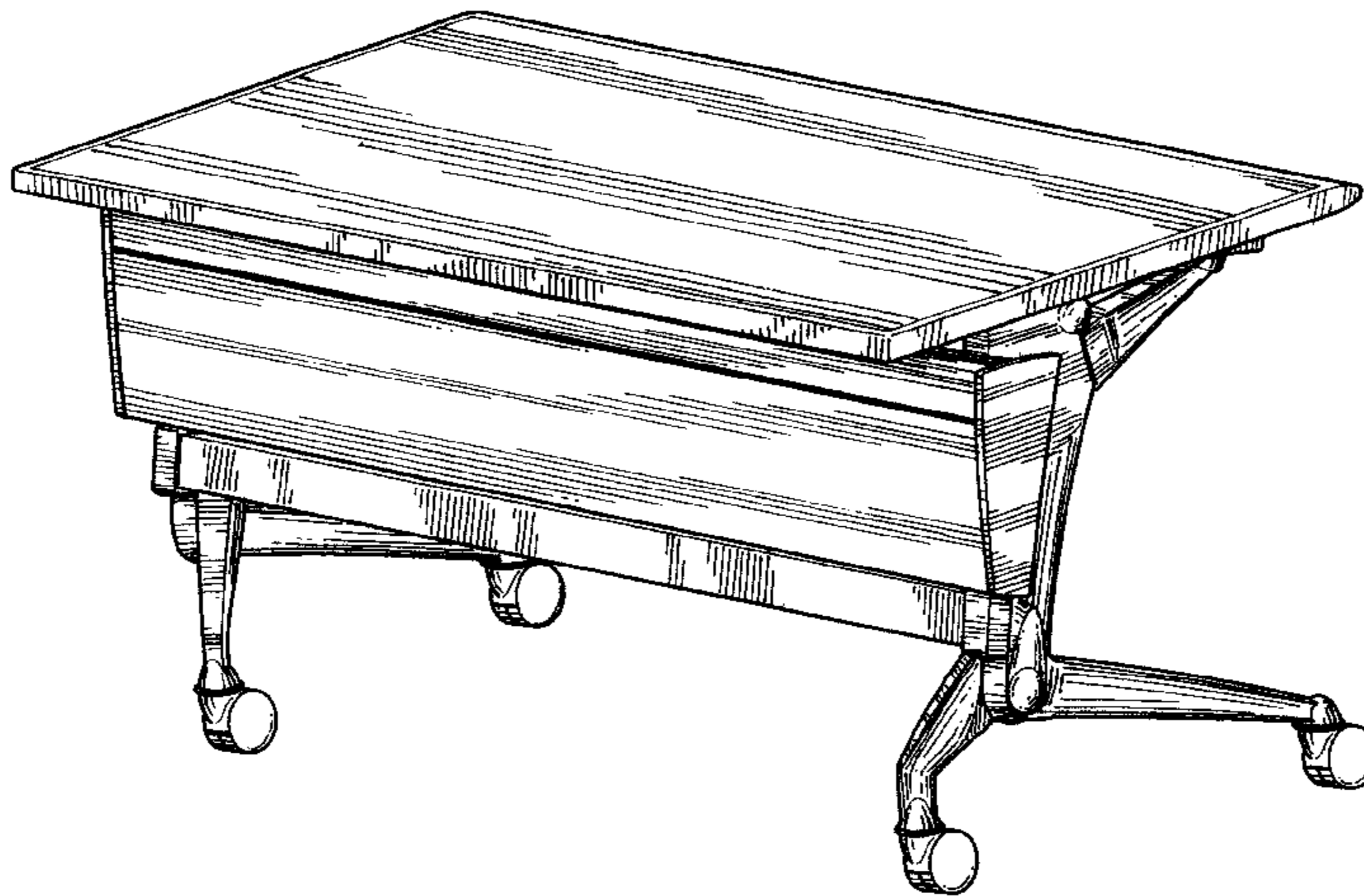

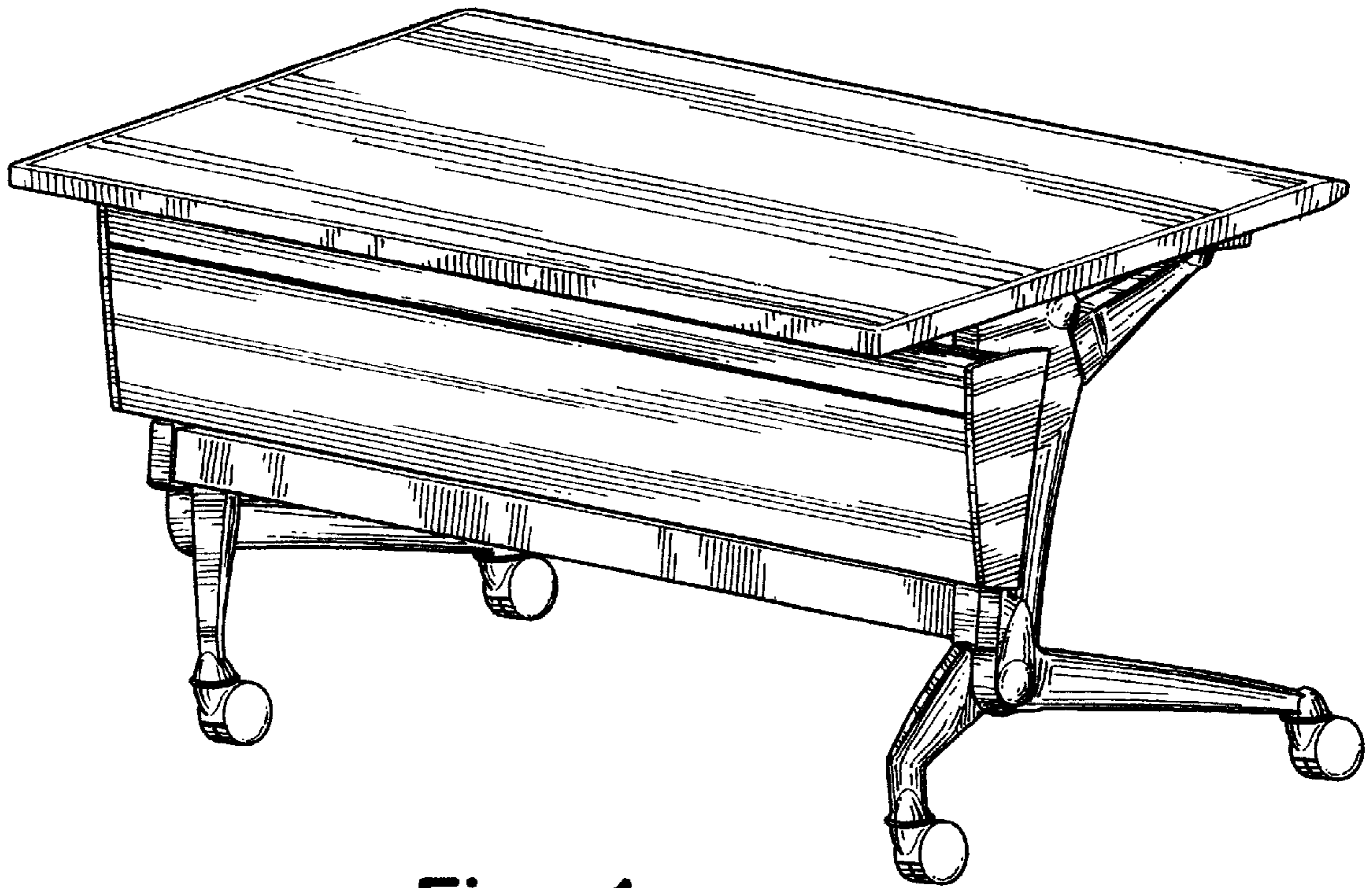

Fig. 1

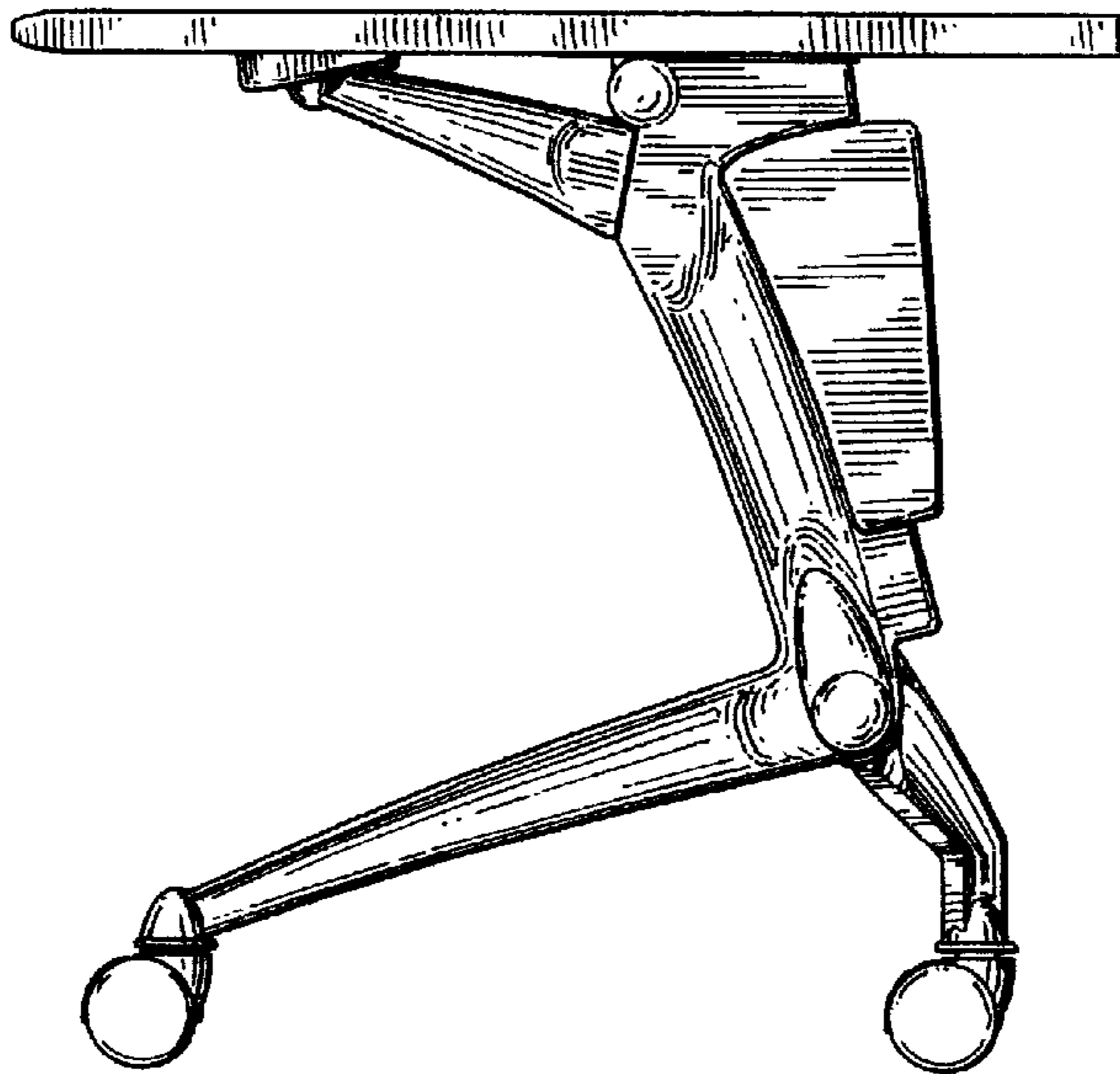

Fig. 2

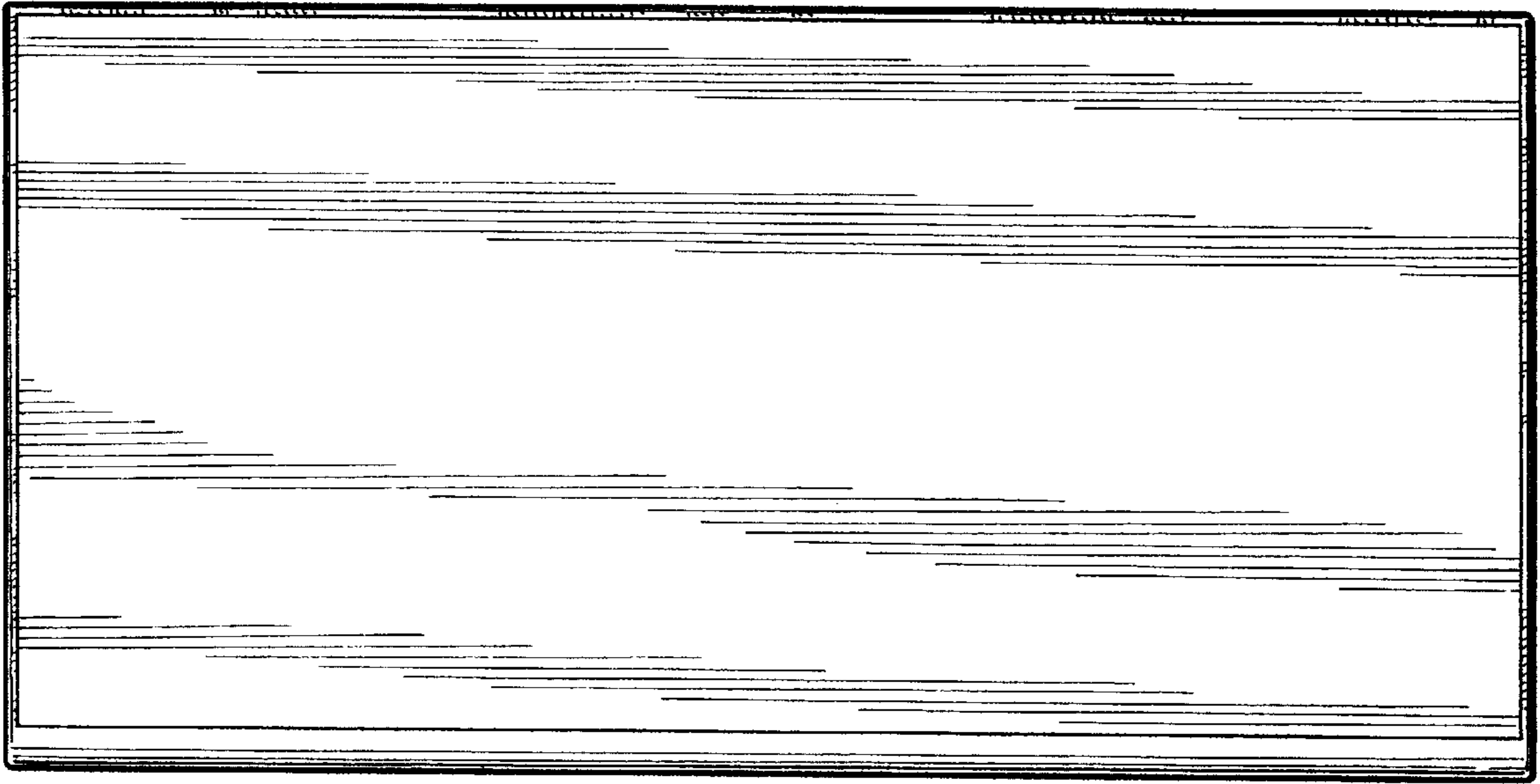

Fig. 3

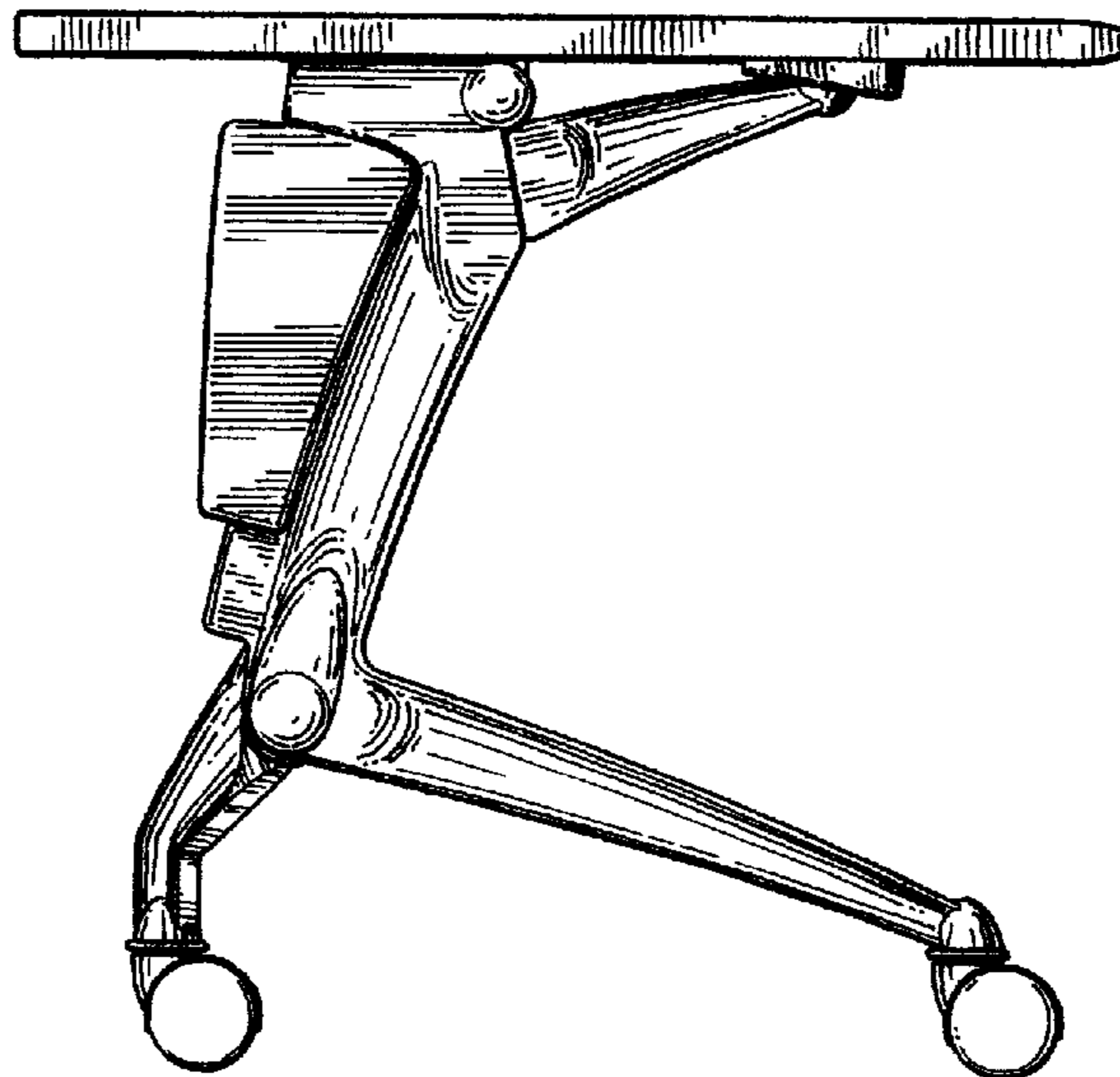

Fig. 4

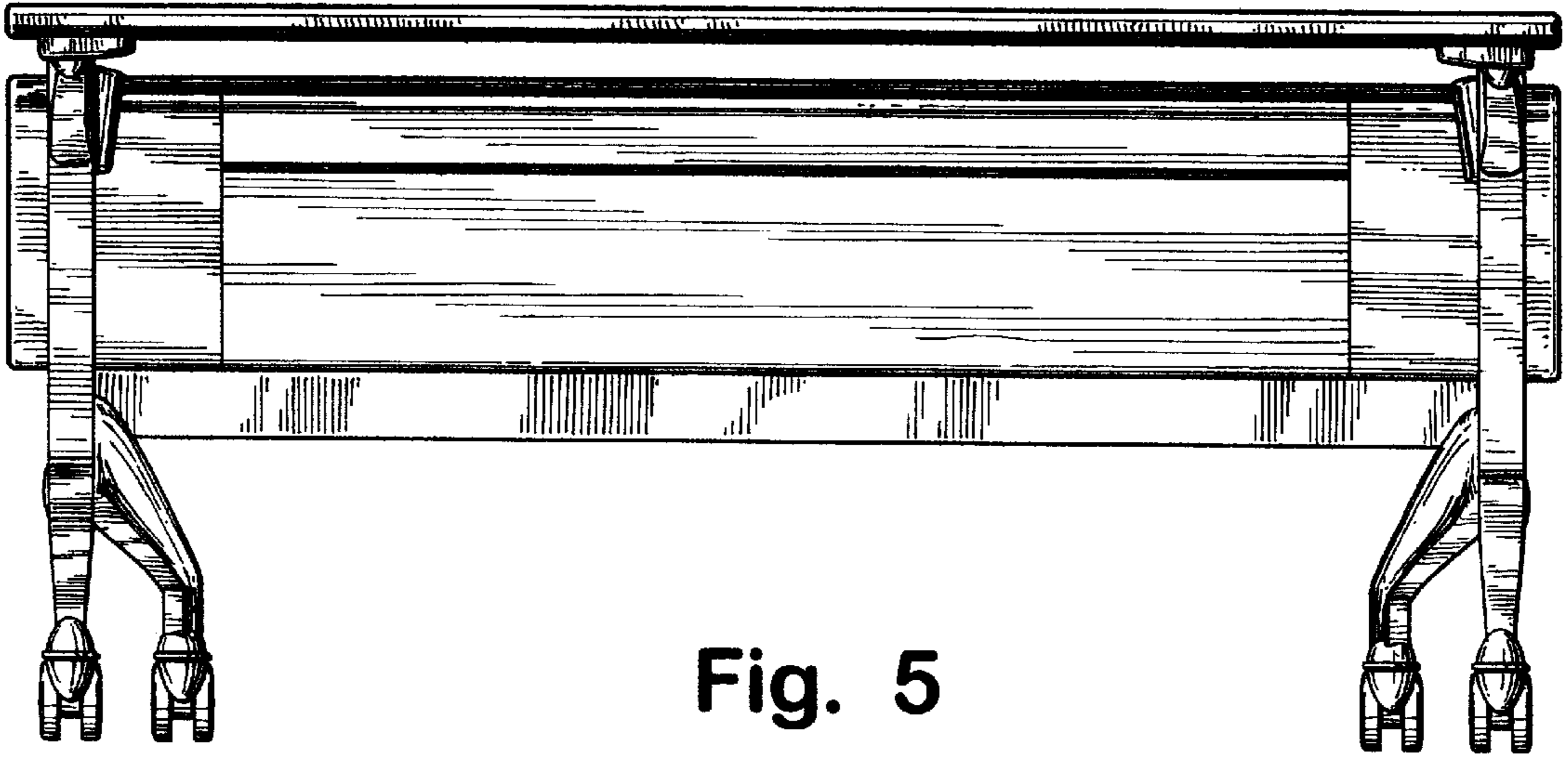

Fig. 5

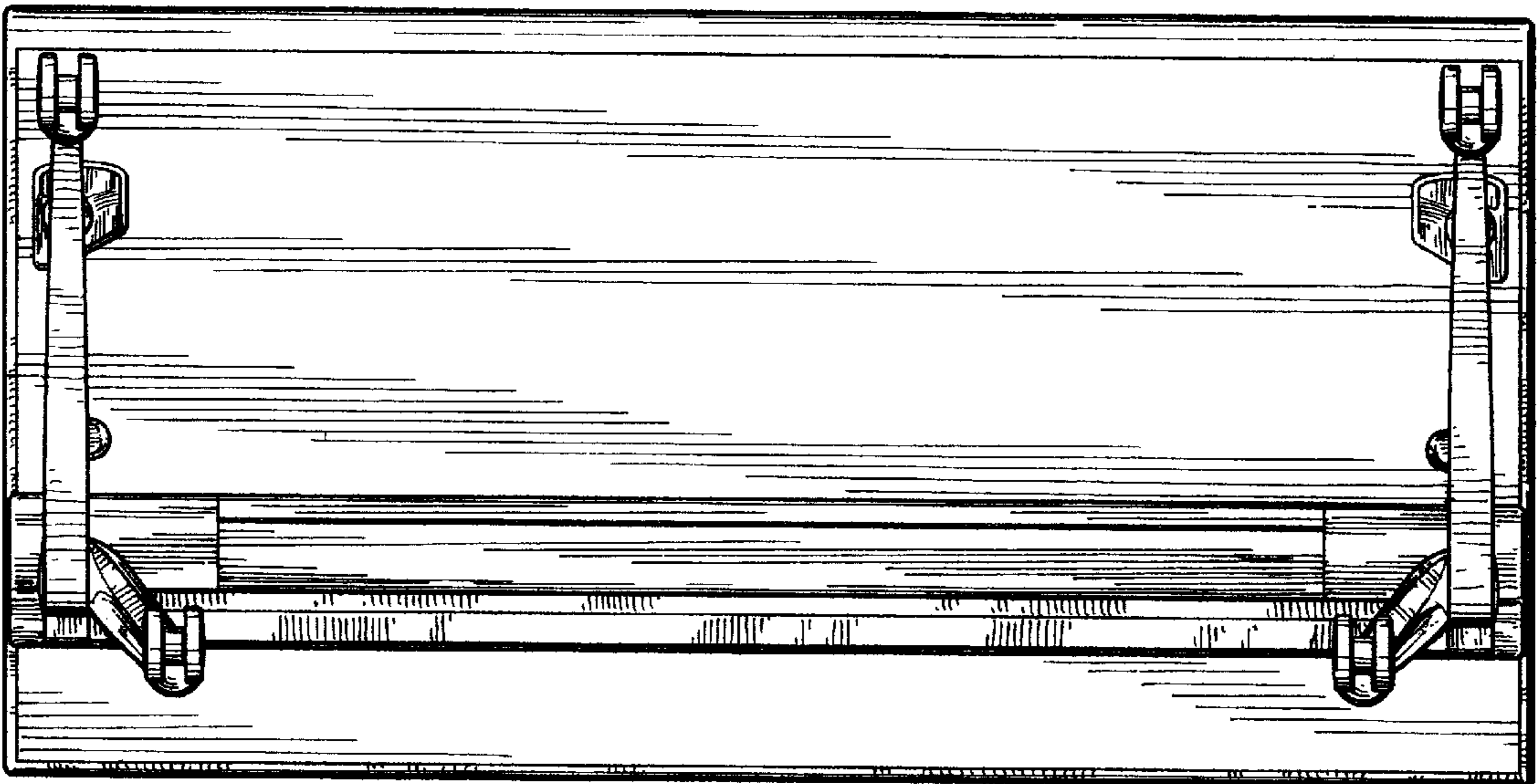

Fig. 6

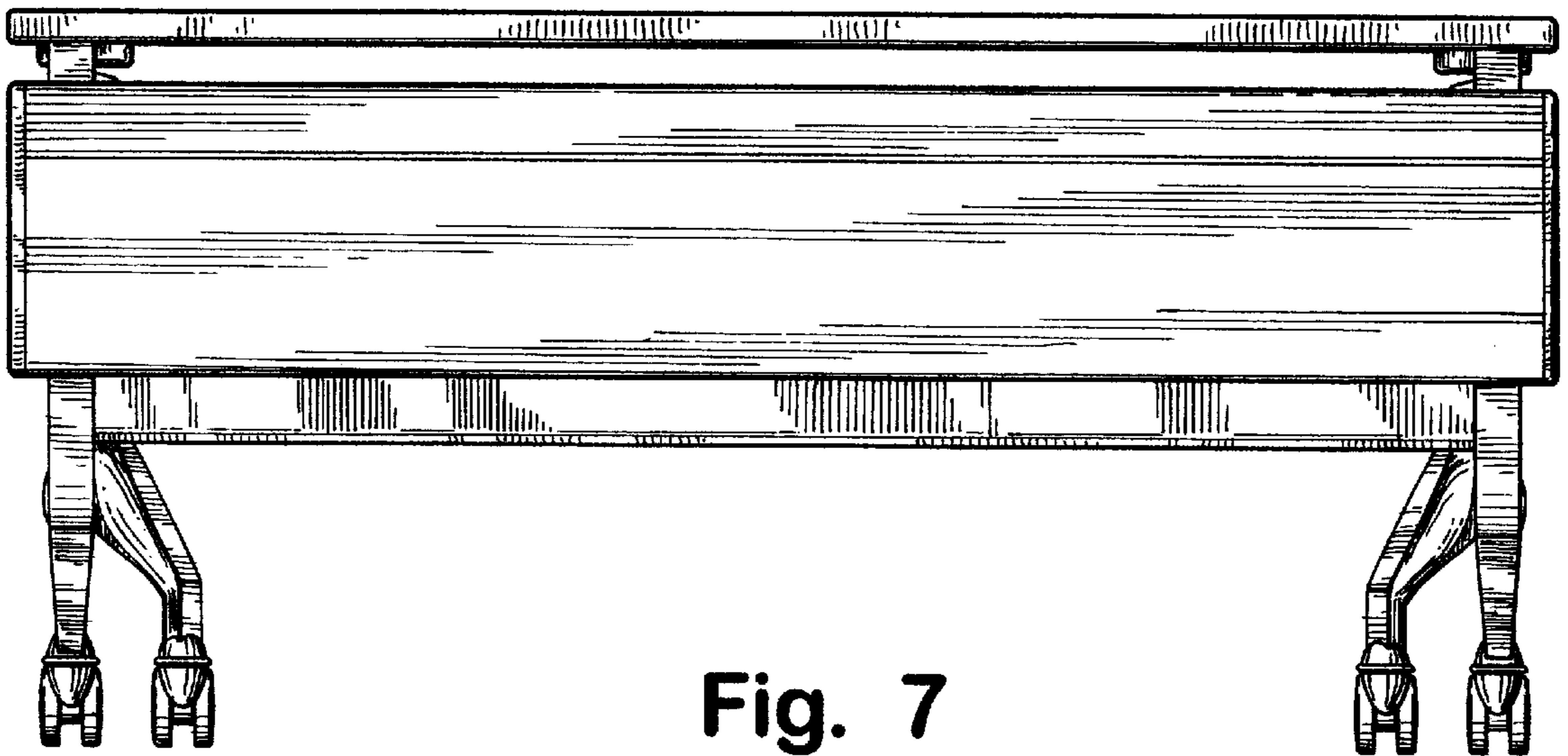

Fig. 7