



US00D443351S

(12) **United States Design Patent**  
**Strand et al.**

(10) **Patent No.:** **US D443,351 S**

(45) **Date of Patent:** **\*\* Jun. 5, 2001**

(54) **KITCHEN FAN**

D. 380,823 \* 7/1997 Lazar ..... D23/372

(75) Inventors: **Markus Strand**, Motala (SE);  
**Matthias Stahl**, Zirndorf (DE)

\* cited by examiner

(73) Assignee: **Aktiebolaget Electrolux**, Stockholm  
(SE)

*Primary Examiner*—Lisa Lichtenstein

(74) *Attorney, Agent, or Firm*—Pearne & Gordon LLP

(\*\*) Term: **14 Years**

(57) **CLAIM**

The ornamental design for a kitchen fan, as shown and described.

(21) Appl. No.: **29/124,704**

(22) Filed: **Jun. 9, 2000**

**DESCRIPTION**

(30) **Foreign Application Priority Data**

Dec. 14, 1999 (SE) ..... 99-2265

FIG. 1 is a bottom front perspective view of a kitchen fan showing our new design;

(51) **LOC (7) Cl.** ..... **23-04**

FIG. 2 is a top front perspective view thereof;

(52) **U.S. Cl.** ..... **D23/372**

FIG. 3 is a front elevation view thereof;

(58) **Field of Search** ..... D23/372, 371;  
D7/406; 126/299 D, 299 R

FIG. 4 is a rear view thereof;

FIG. 5 is a right hand side view thereof;

FIG. 6 is a left hand side view thereof;

FIG. 7 is a bottom view thereof; and,

FIG. 8 is a top plan view thereof.

(56) **References Cited**

**U.S. PATENT DOCUMENTS**

D. 231,615 \* 5/1974 Nygard ..... D23/372

**1 Claim, 8 Drawing Sheets**

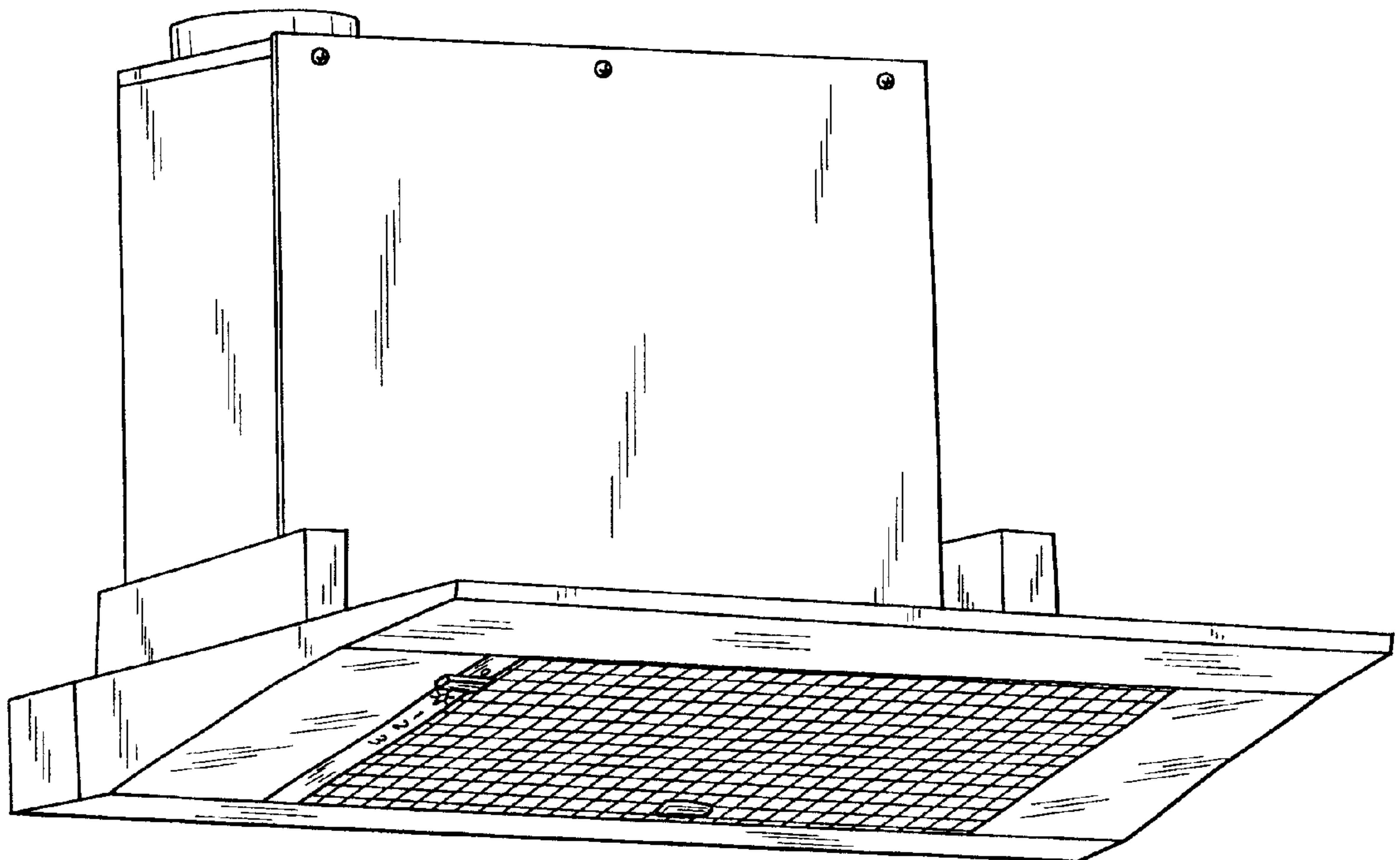

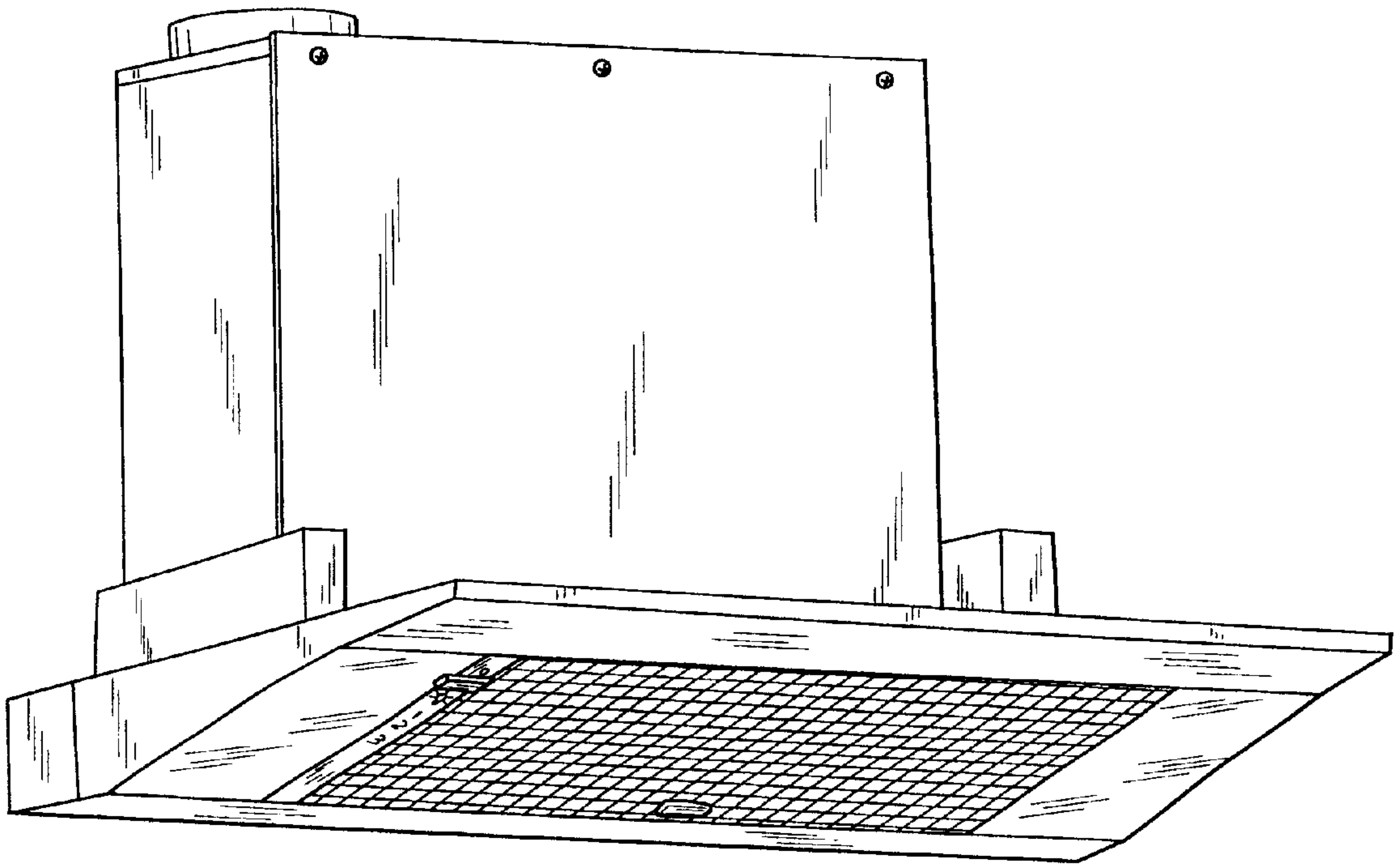

FIG. 1

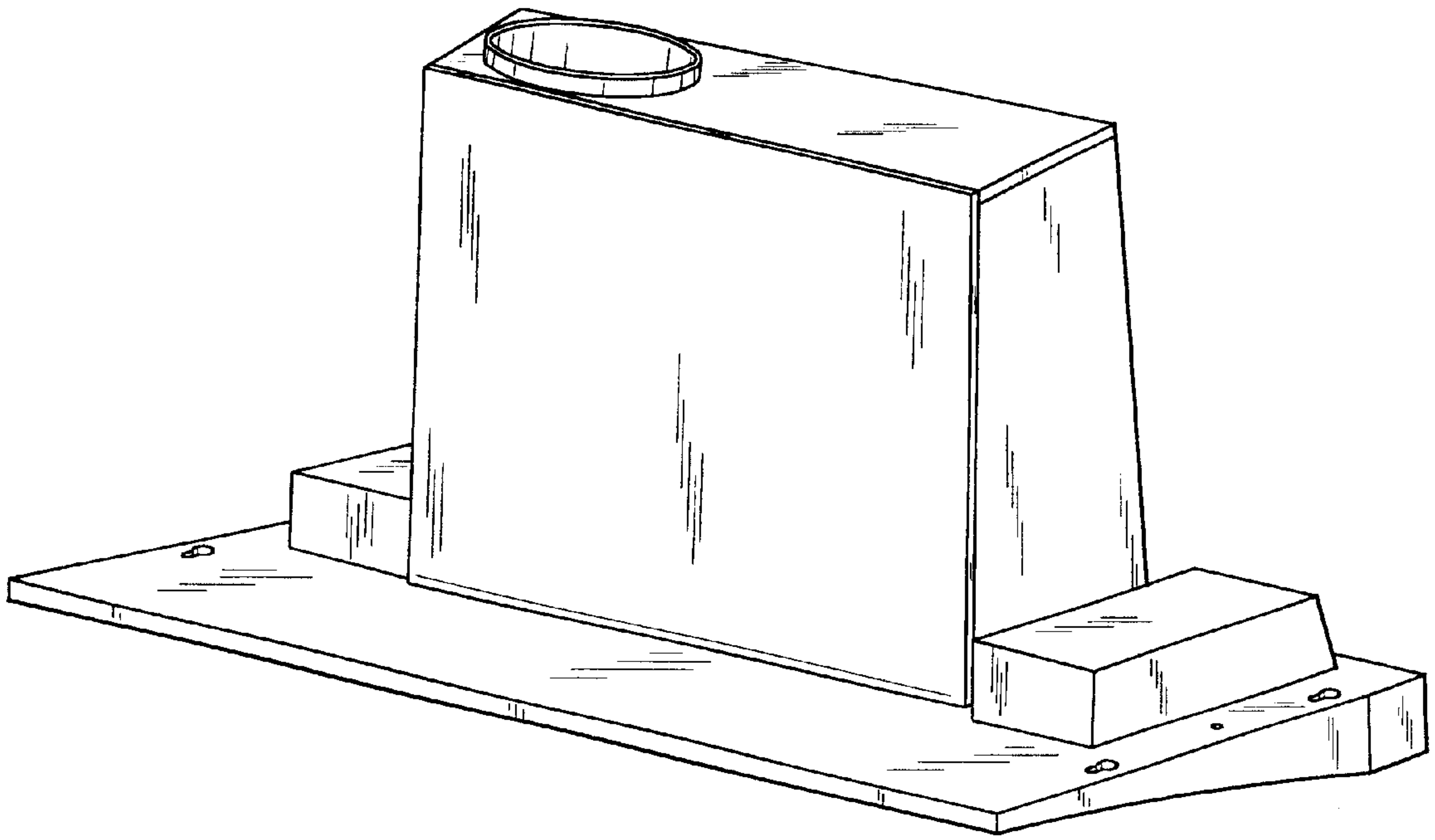

FIG. 2

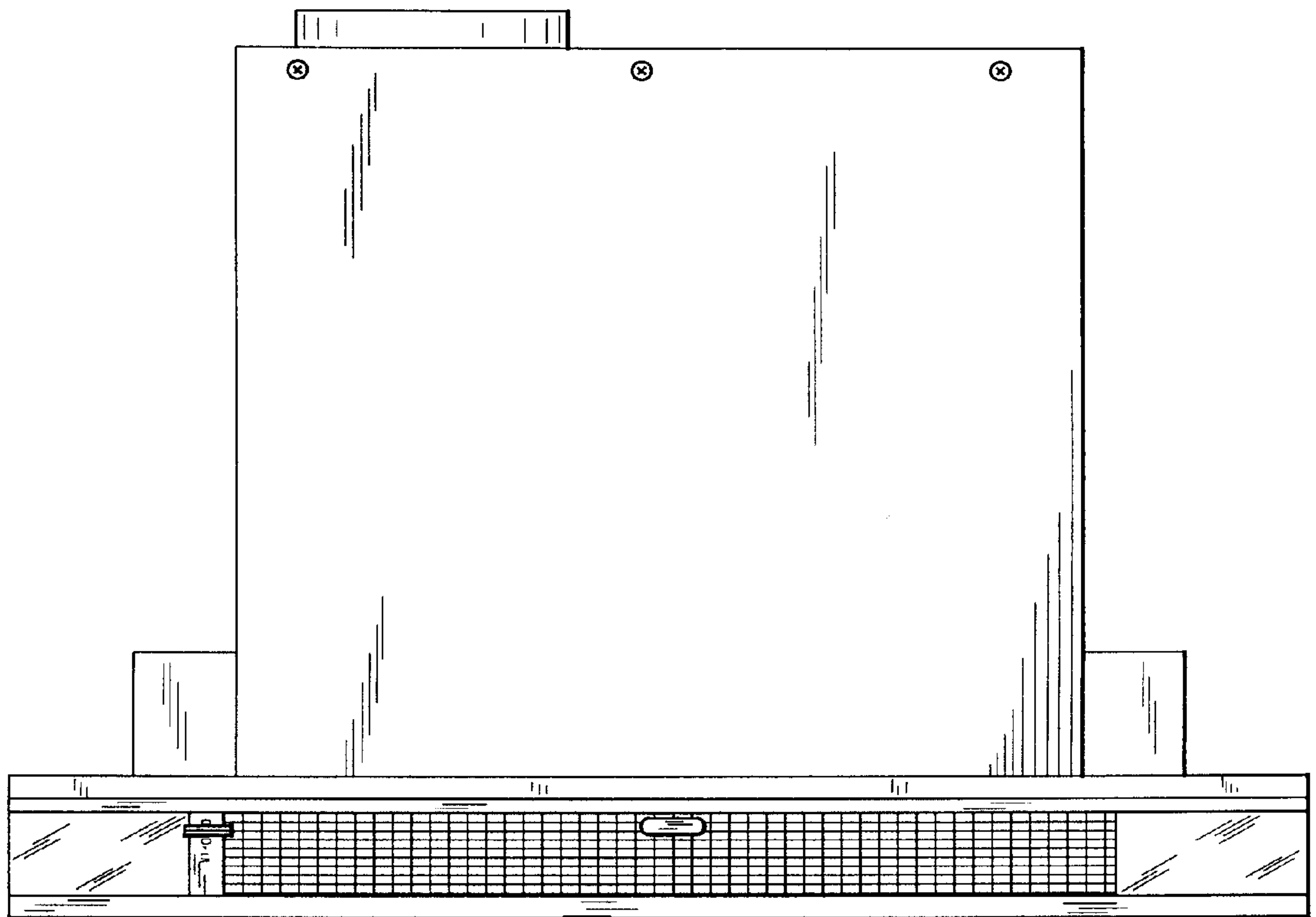

FIG. 3

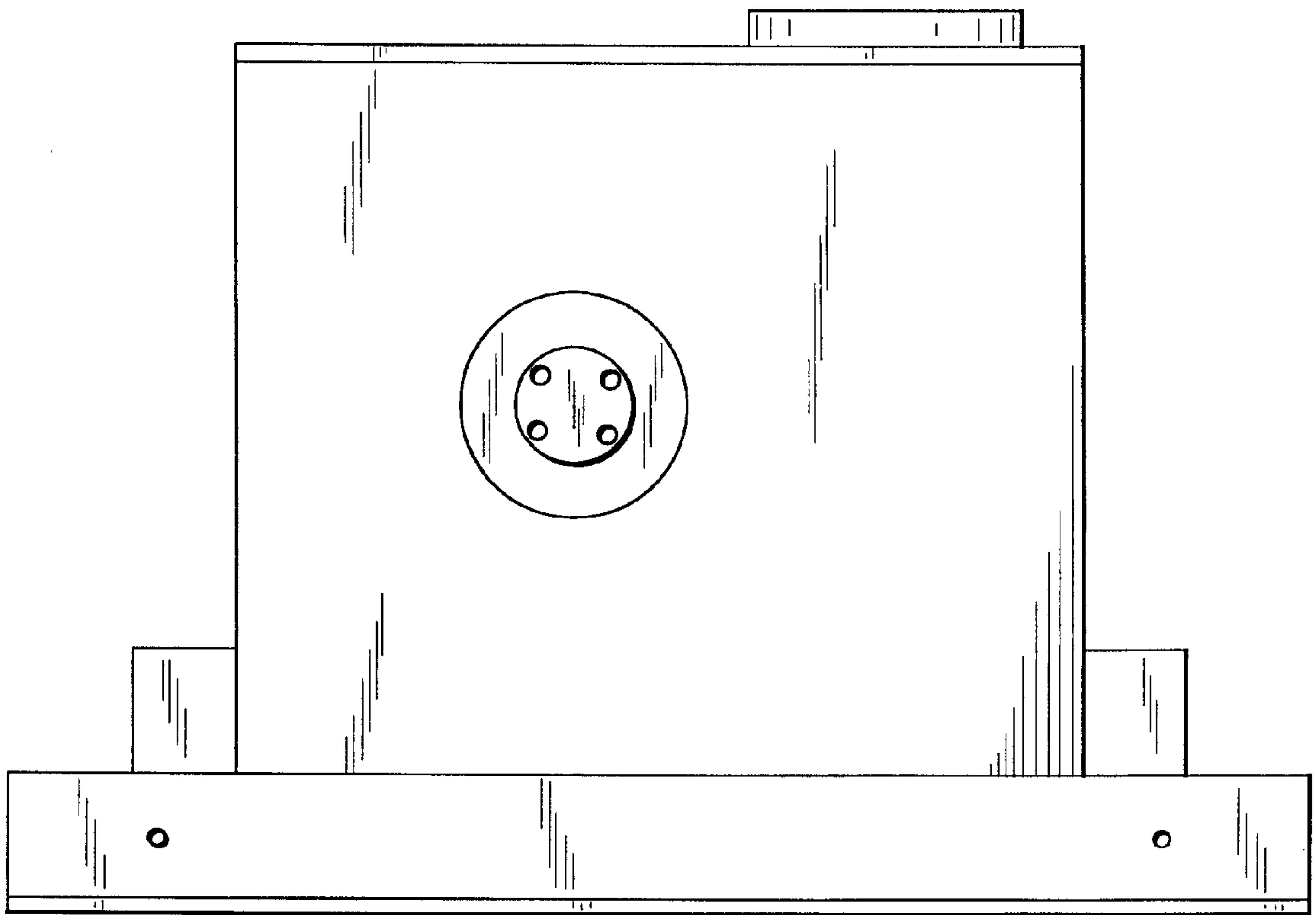

FIG. 4

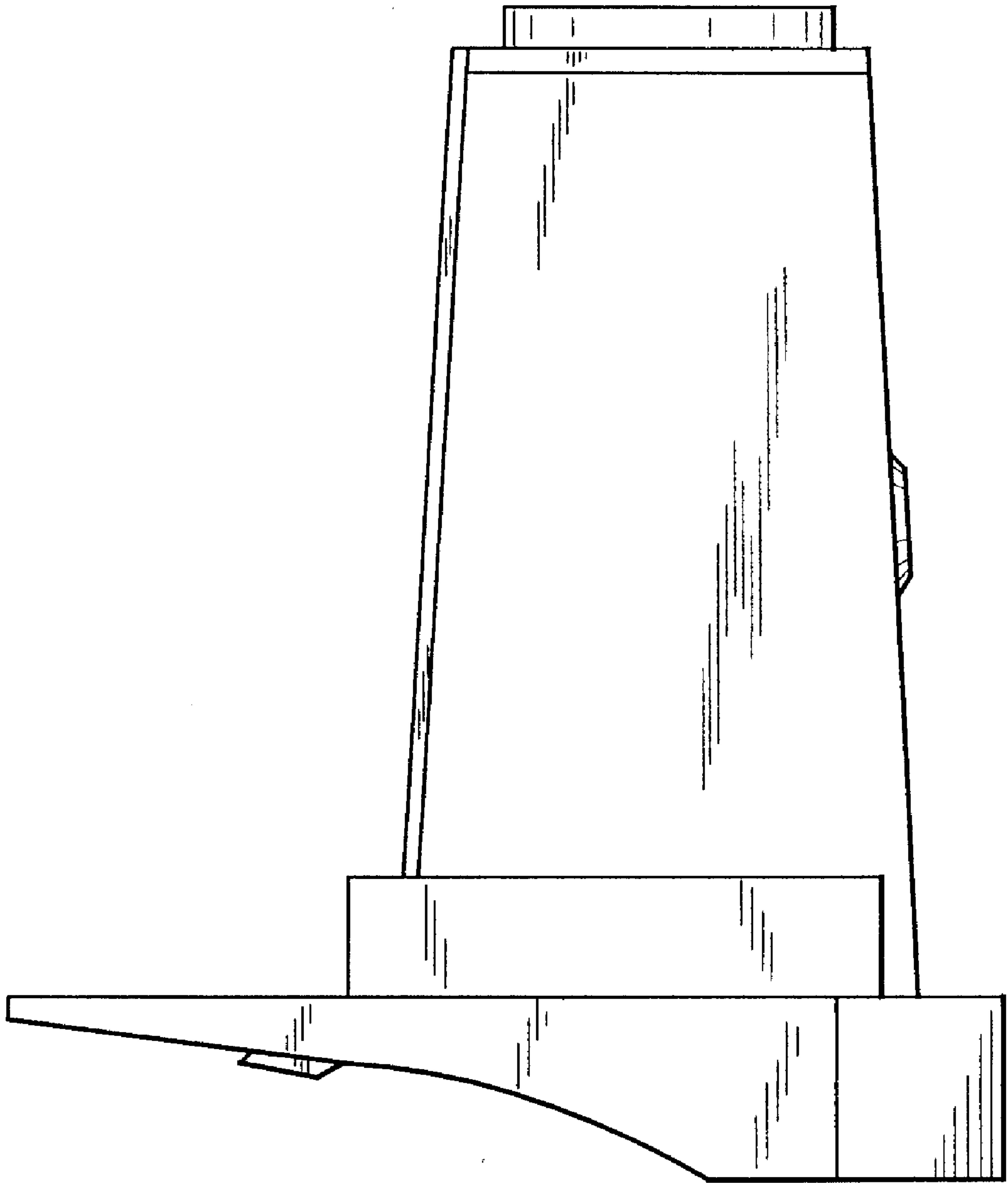

FIG. 5

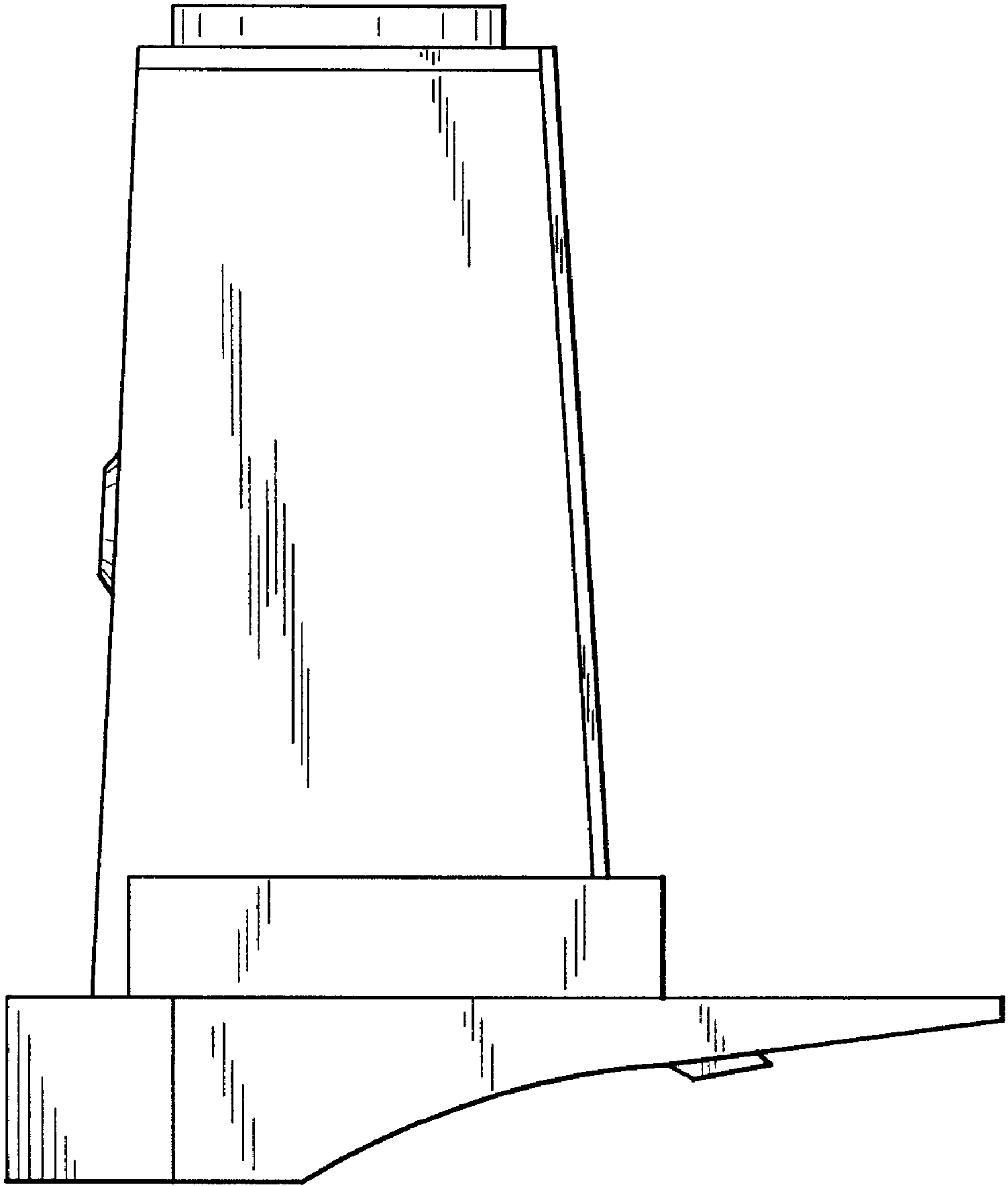

FIG. 6

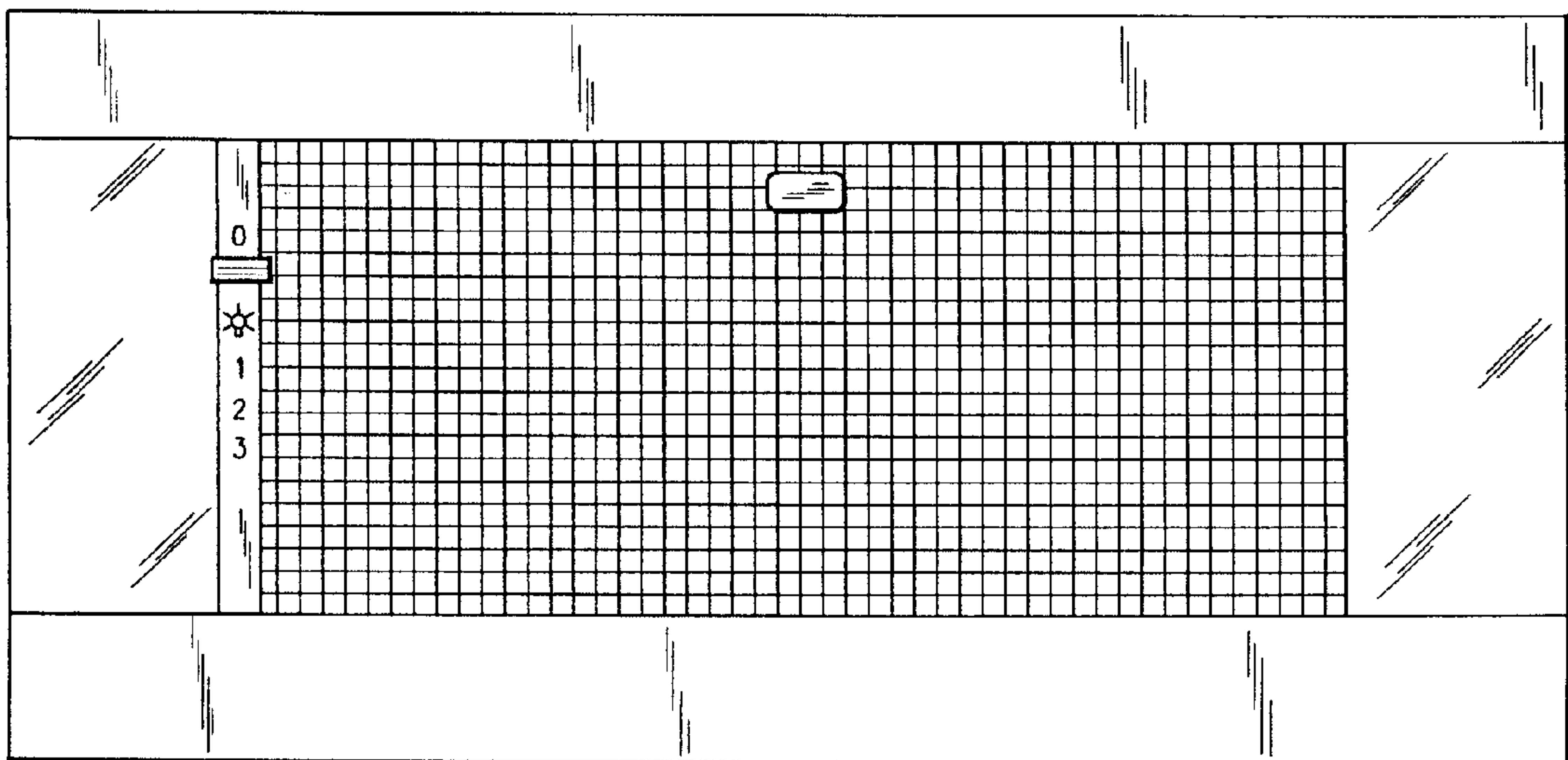

FIG. 7



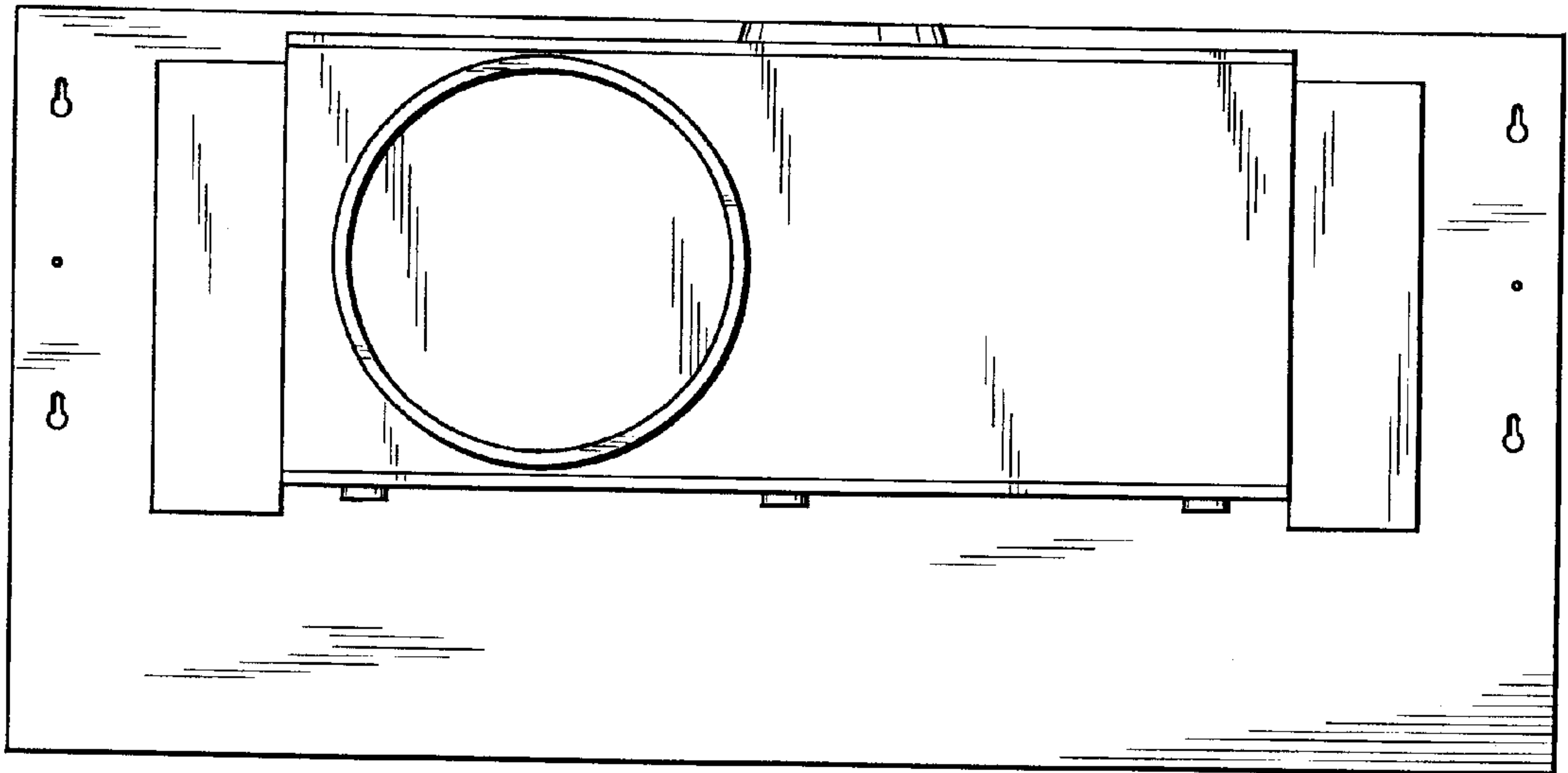

FIG. 8