



US00D443263S

(12) **United States Design Patent**
Strand et al.

(10) **Patent No.:** **US D443,263 S**

(45) **Date of Patent:** **** Jun. 5, 2001**

(54) **ANTENNA ENCLOSURE**

(75) Inventors: **Johan Strand, Åkersberga; Erik Engwall, Vaxholm, both of (SE)**

(73) Assignee: **Smarteq Wireless AB, Enebyberg (SE)**

(**) Term: **14 Years**

(21) Appl. No.: **29/121,501**

(22) Filed: **Apr. 10, 2000**

(30) **Foreign Application Priority Data**

Oct. 8, 1999 (SE) 99-1830

(51) **LOC (7) Cl.** **14-03**

(52) **U.S. Cl.** **D14/230**

(58) **Field of Search** **D14/230-238;**
343/702, 872, 888, 715

(56) **References Cited**

U.S. PATENT DOCUMENTS

D. 371,795	7/1996	Mailandt	D14/230
D. 378,592	3/1997	Hartwig et al.	D14/230
D. 429,720	* 8/2000	Strand	D14/230
2,419,480	4/1947	Bryan et al.	250/33
2,473,141	* 6/1949	Friedberg	343/888
3,175,220	* 3/1965	Schetne	343/872
4,471,493	9/1984	Schober	455/90
4,728,962	3/1988	Kitsuda et al.	343/872

FOREIGN PATENT DOCUMENTS

3010129	* 10/1981	(DE)	343/715
2049646	8/1995	(GB)	.	
98-1464	7/1998	(SE)	.	

OTHER PUBLICATIONS

U.S. application No. 29/110664, Strand et al., filed Sep. 13, 1999.

* cited by examiner

Primary Examiner—Louis S. Zarfes

Assistant Examiner—Gregory Andoll

(74) *Attorney, Agent, or Firm*—Jacobson, Price, Holman & Stern, PLLC

(57) **CLAIM**

The ornamental design for an antenna enclosure, as shown and described.

DESCRIPTION

FIG 1. is a bottom plan view showing our new design for an antenna enclosure;

FIG 2. is a front view thereof;

FIG 3. is a left side view thereof;

FIG 4. is a top plan view thereof;

FIG 5. is a left side perspective view thereof;

FIG 6. is a rear view thereof;

FIG 7. is a right view thereof;

FIG 8. is a top perspective view thereof;

FIG 9. is a bottom plan view of the base portion of the antenna enclosure;

FIG 10. is a front view thereof;

FIG 11. is a left side view thereof;

FIG 12. is a top plan view thereof;

FIG 13. is a left side perspective view thereof;

FIG 14. is a rear view thereof;

FIG 15. is a right side view thereof;

FIG 16. is a top perspective view thereof;

FIG 17. is a front view of the lid portion of the antenna enclosure;

FIG 18. is a front perspective view thereof;

FIG 19. is a bottom plan view thereof; and;

FIG 20. is a top perspective view thereof.

1 Claim, 5 Drawing Sheets

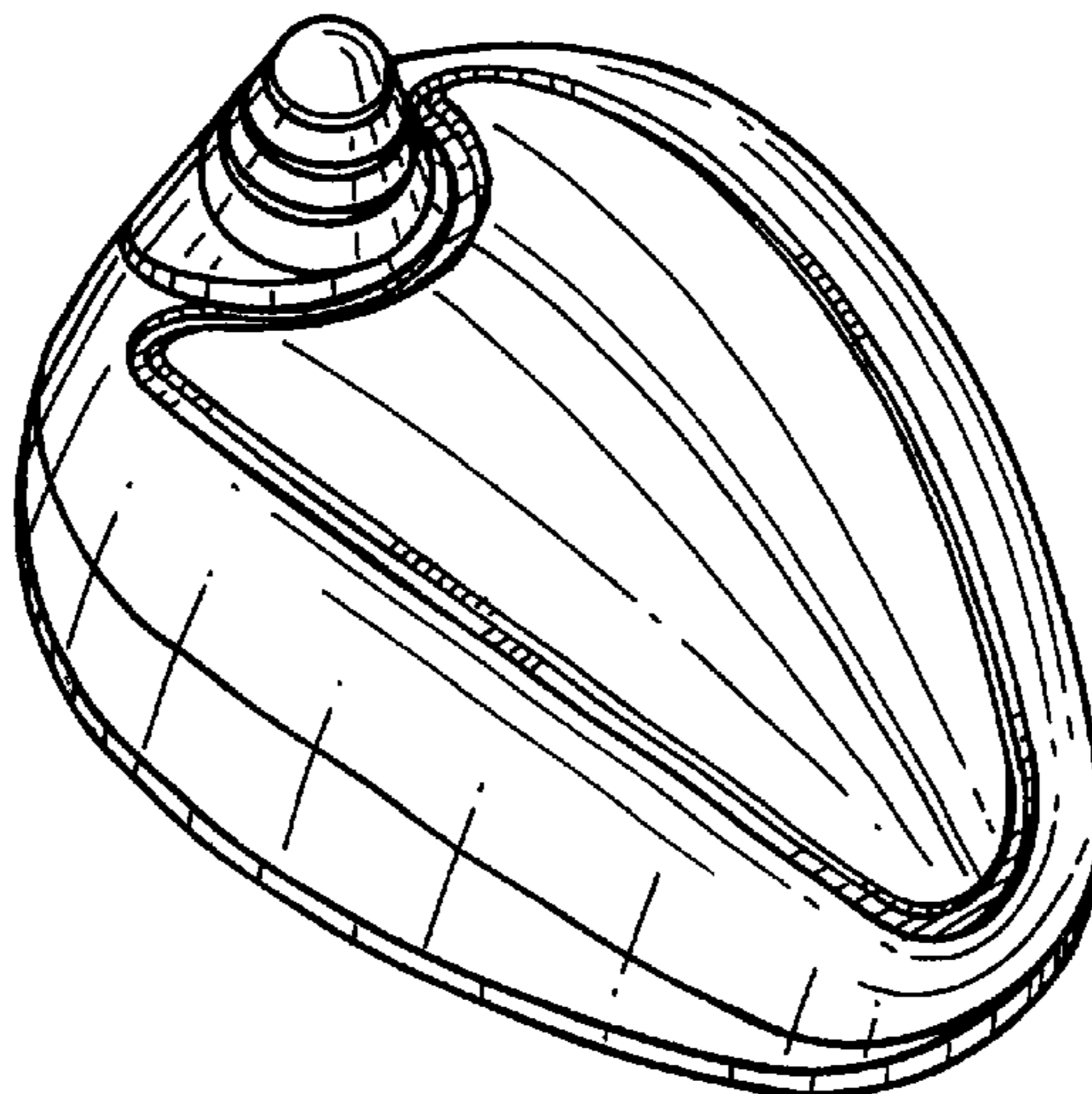

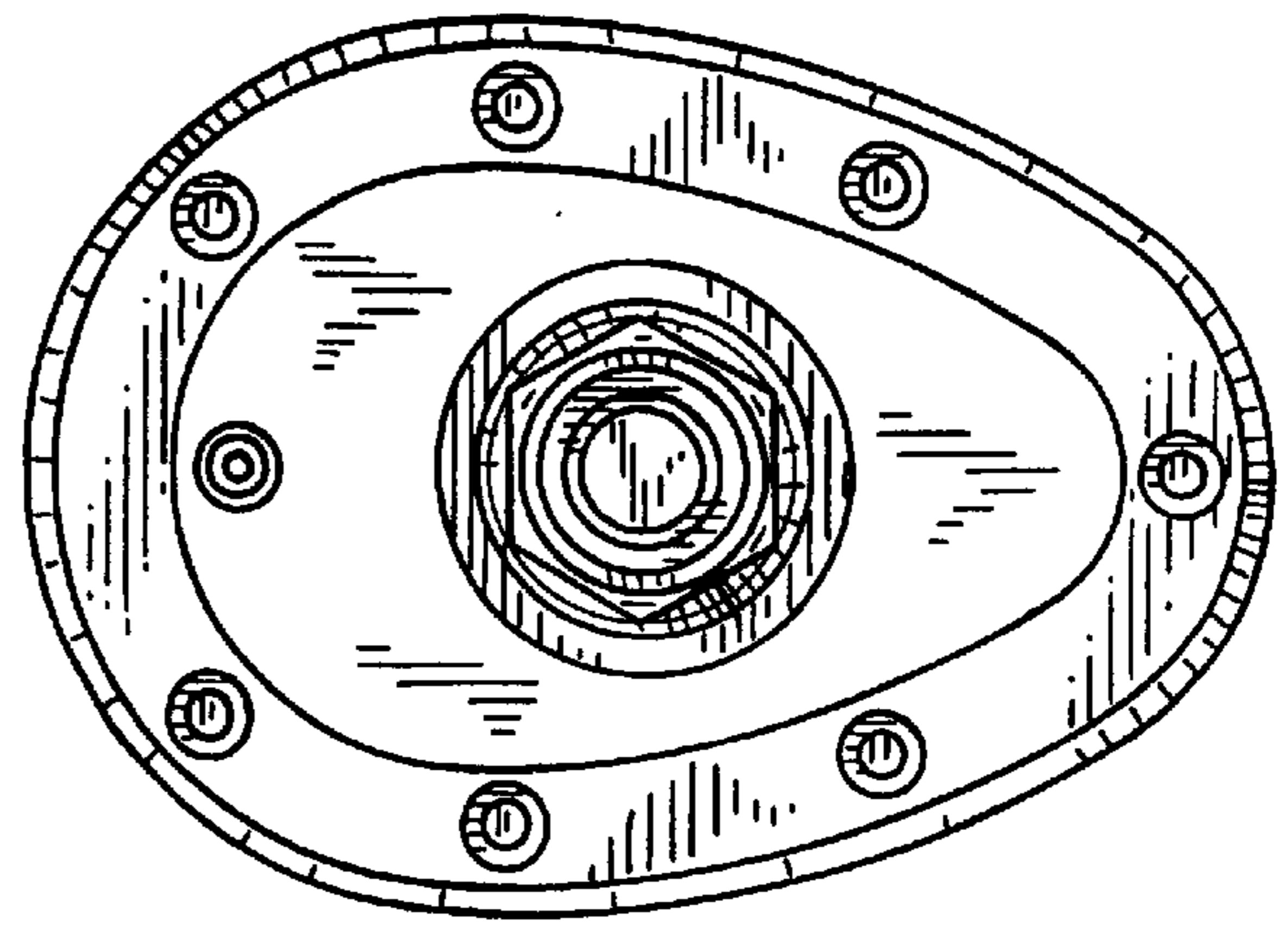

FIG. 1

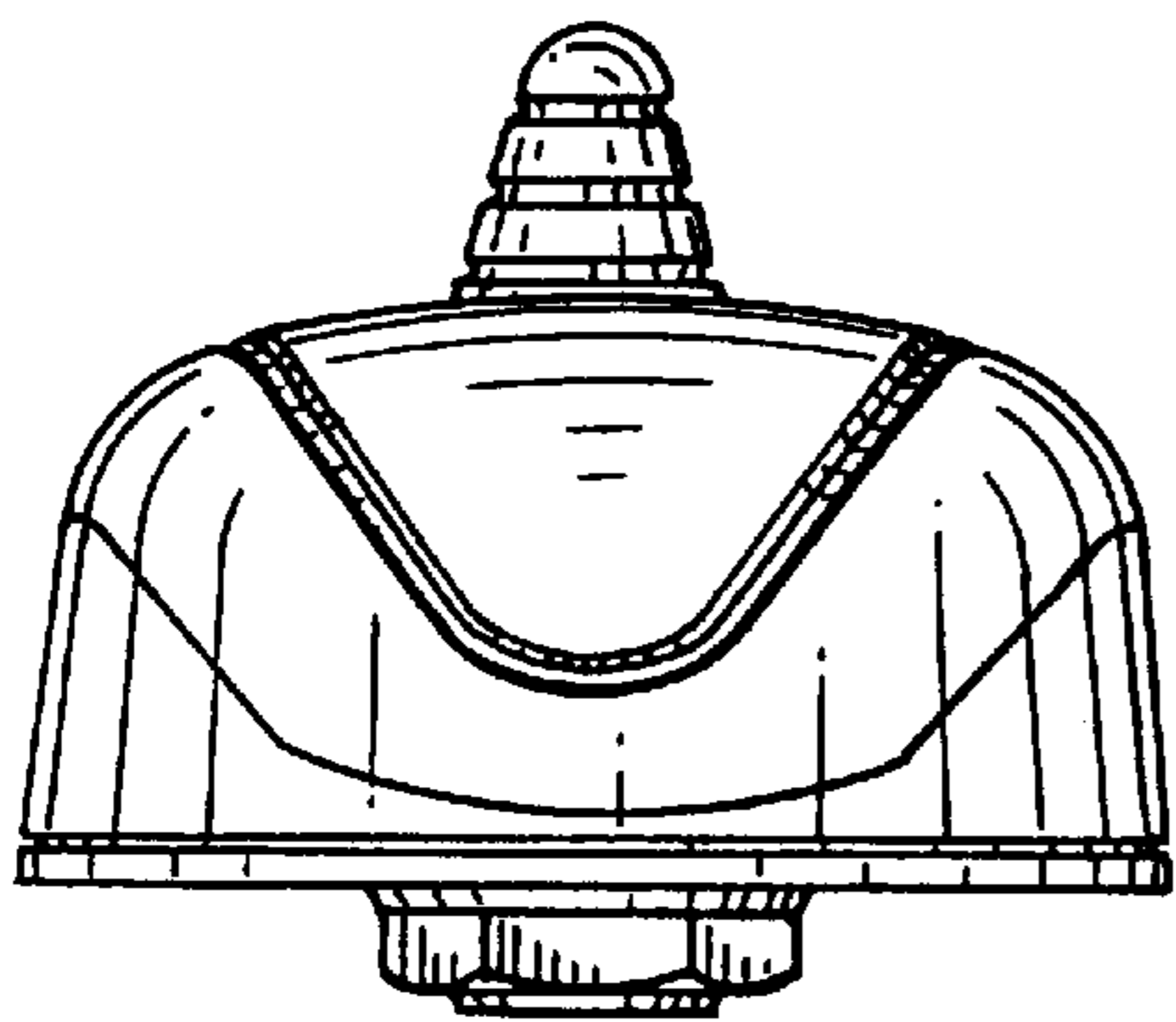

FIG. 2

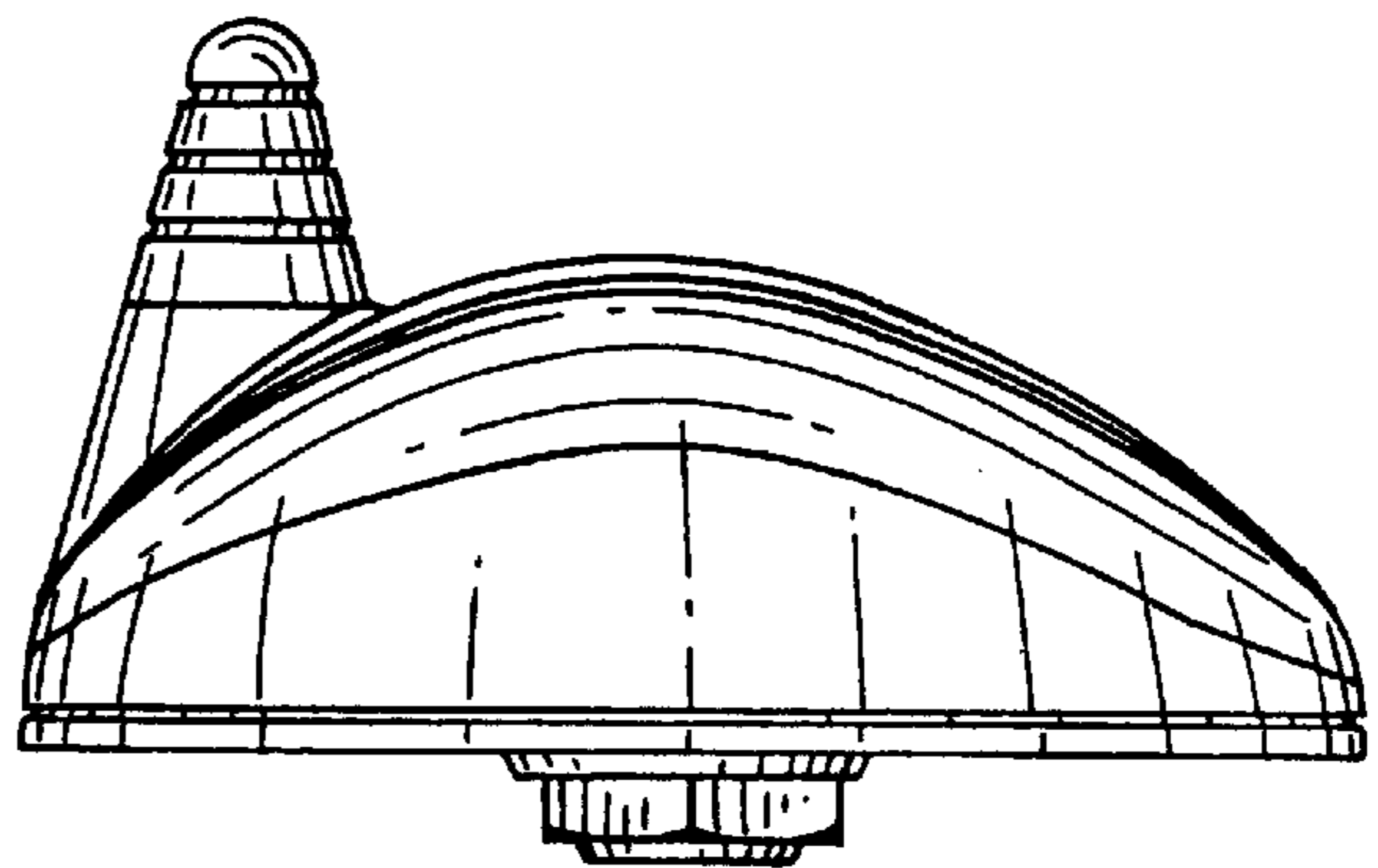

FIG. 3

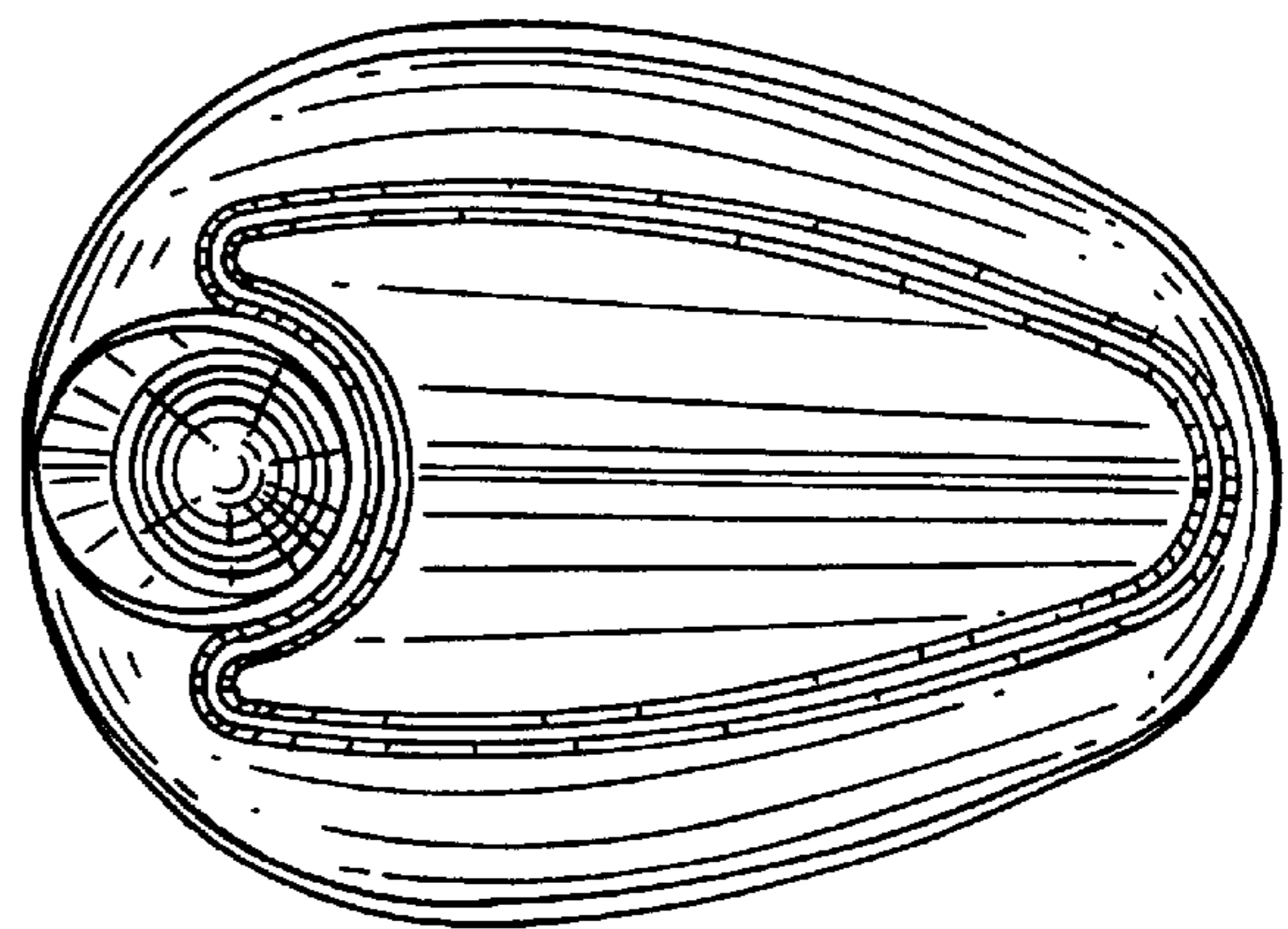

FIG. 4

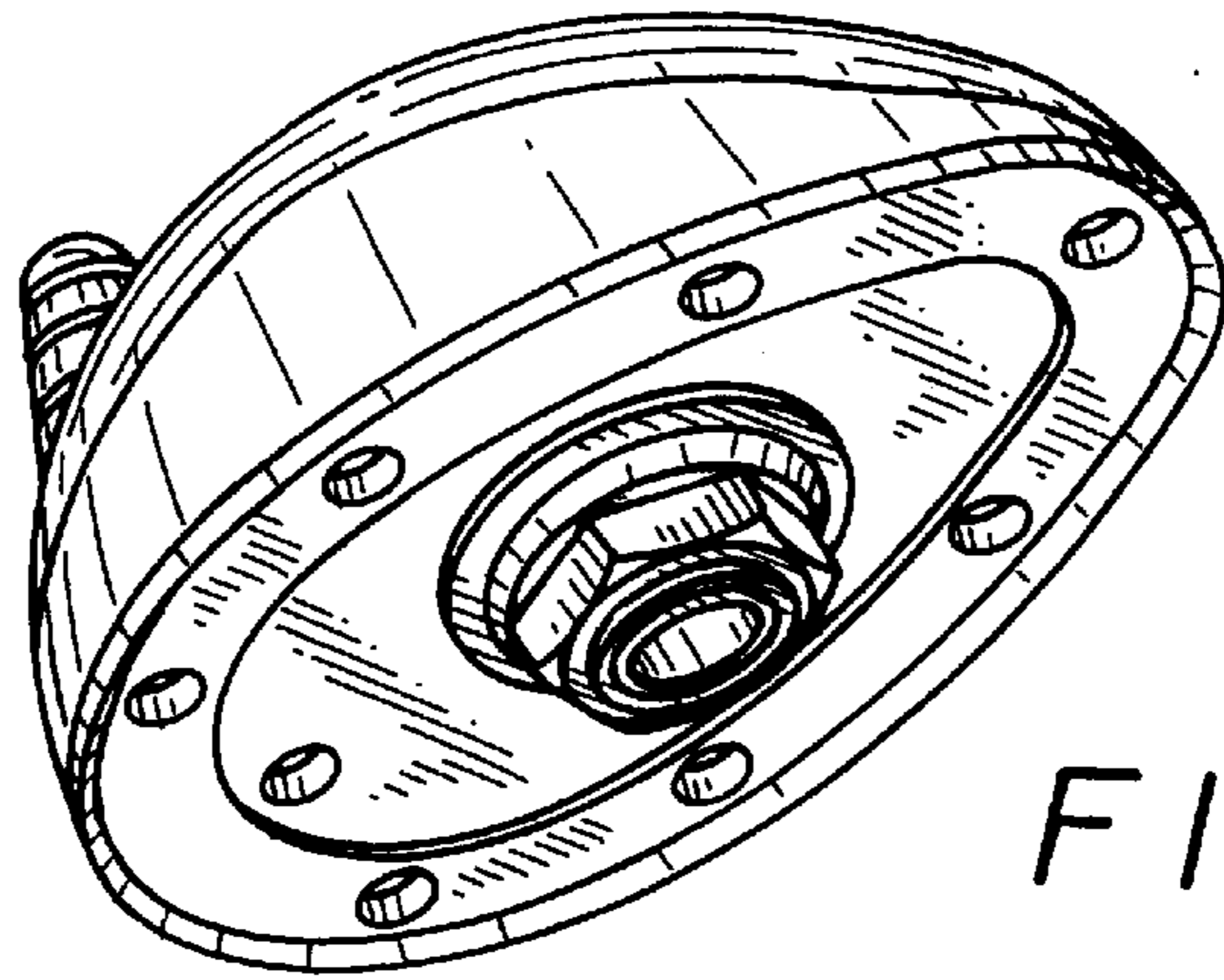

FIG. 5

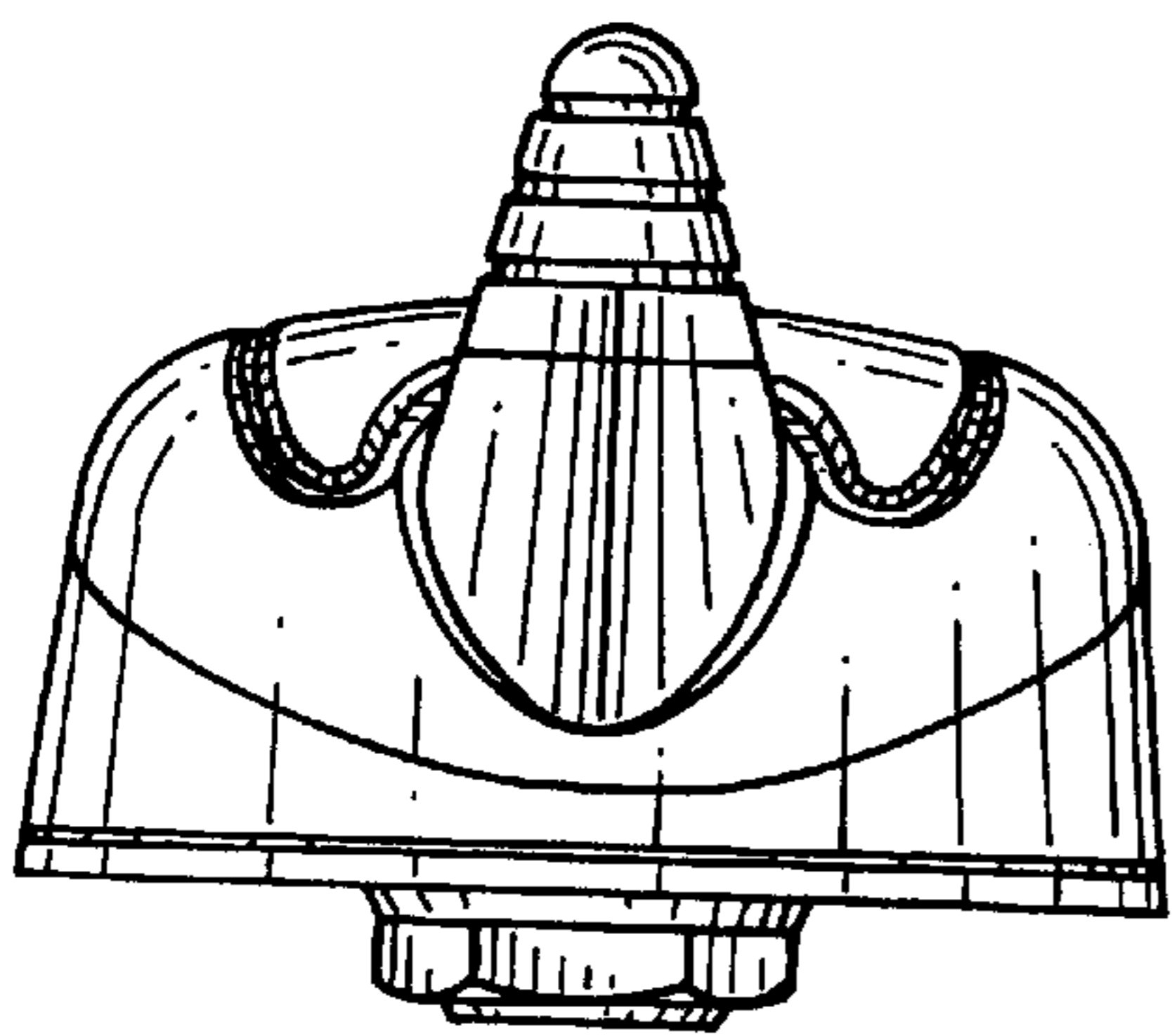

FIG. 6

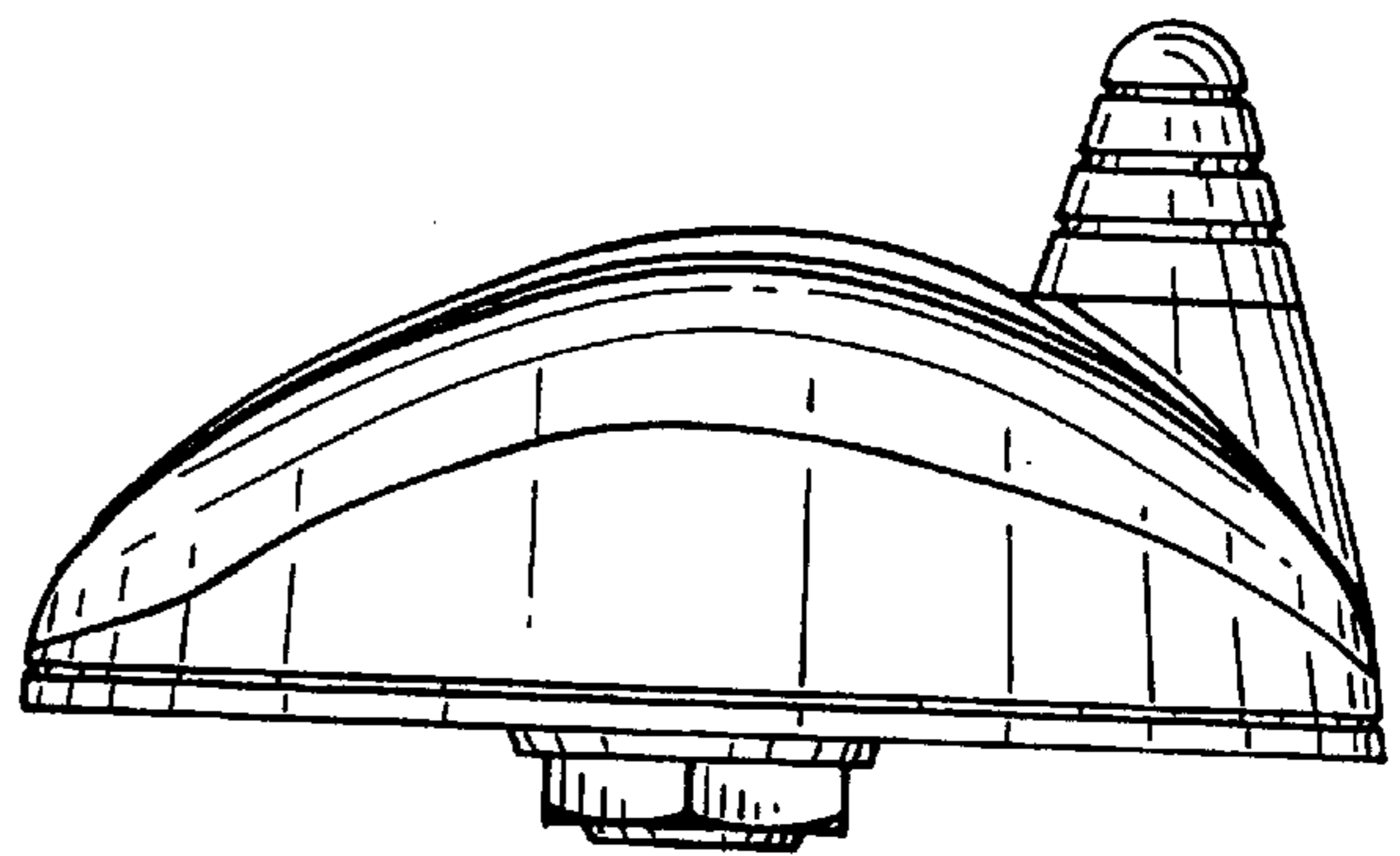

FIG. 7

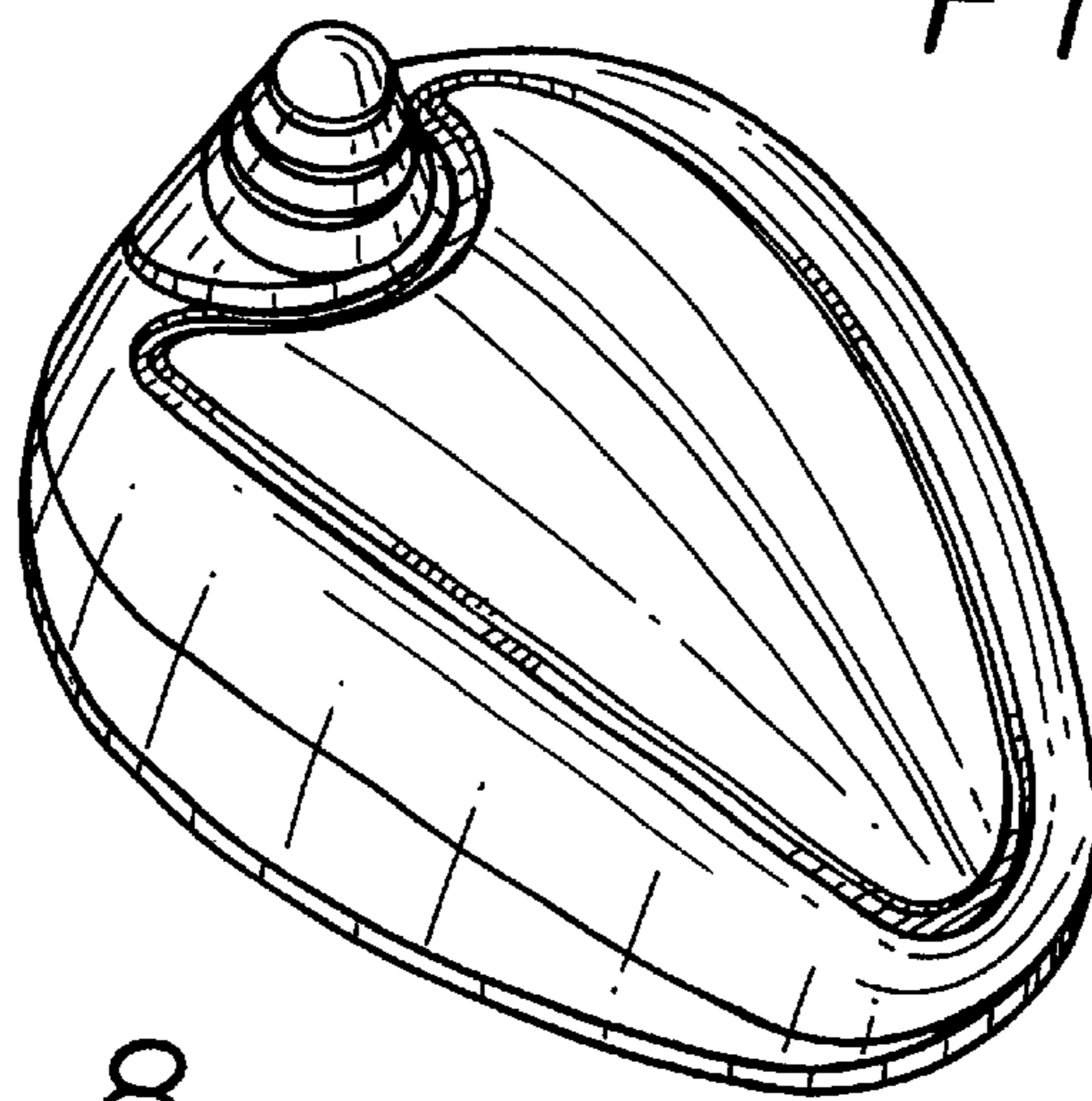

FIG. 8

FIG. 9

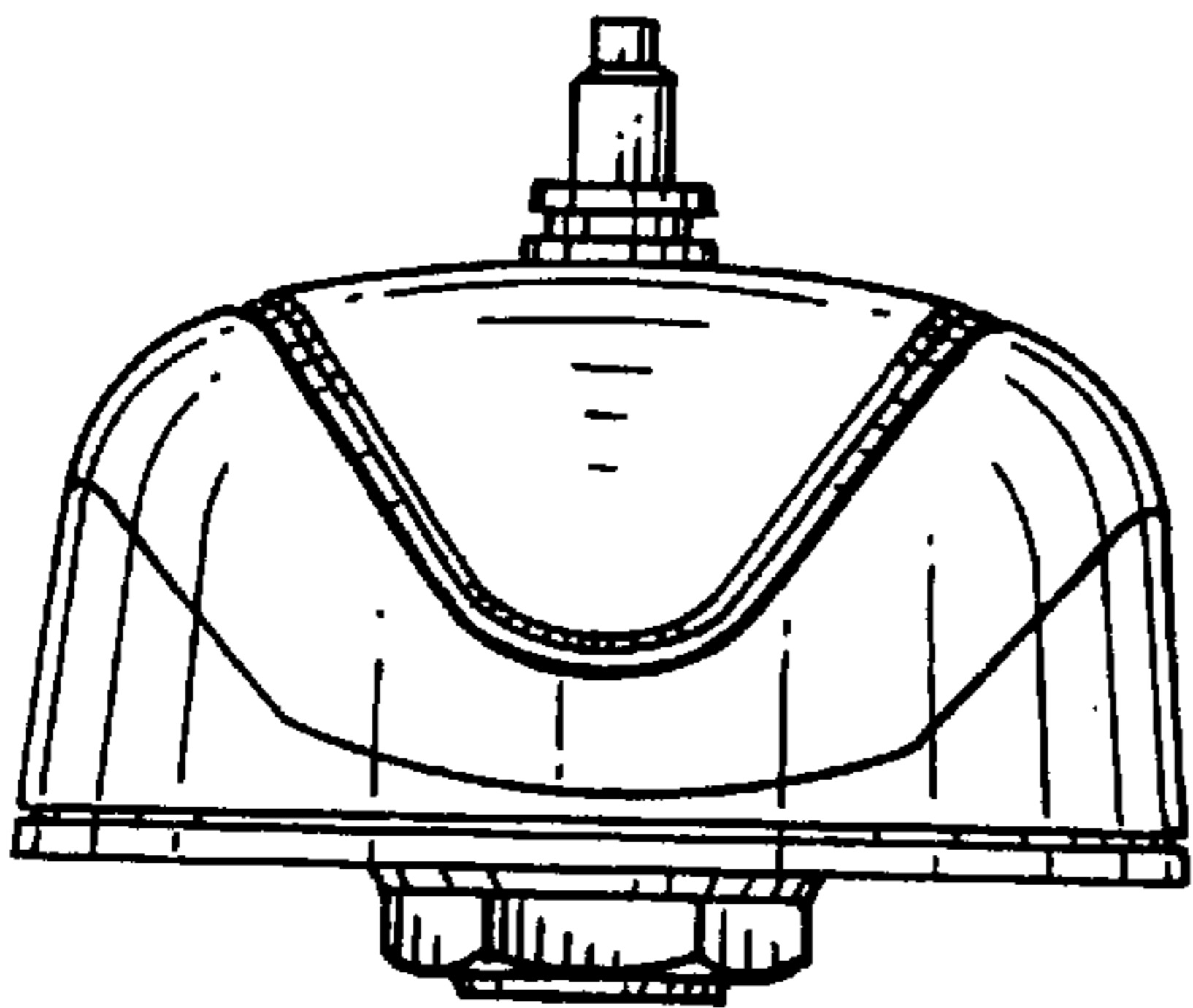
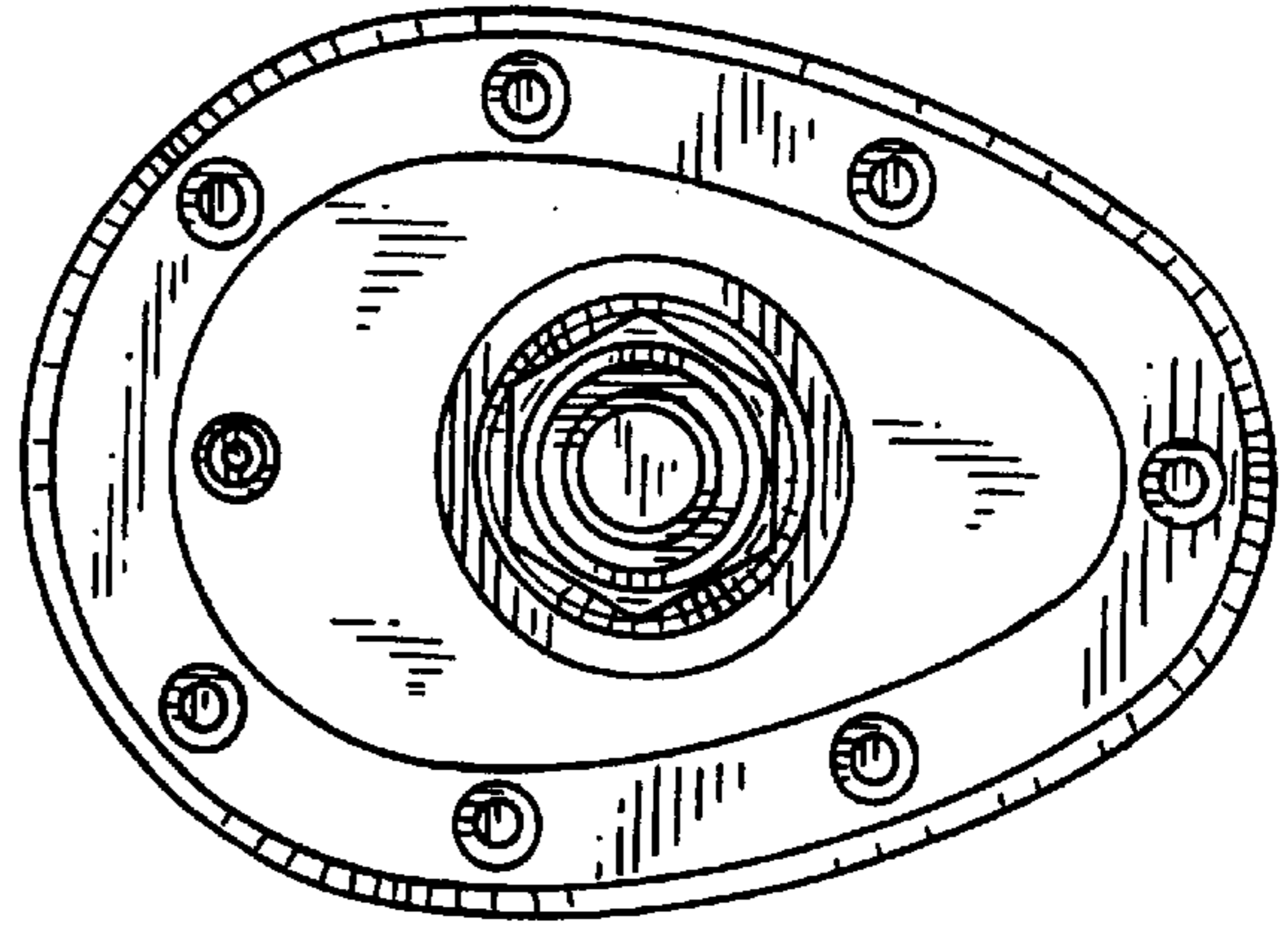

FIG. 10

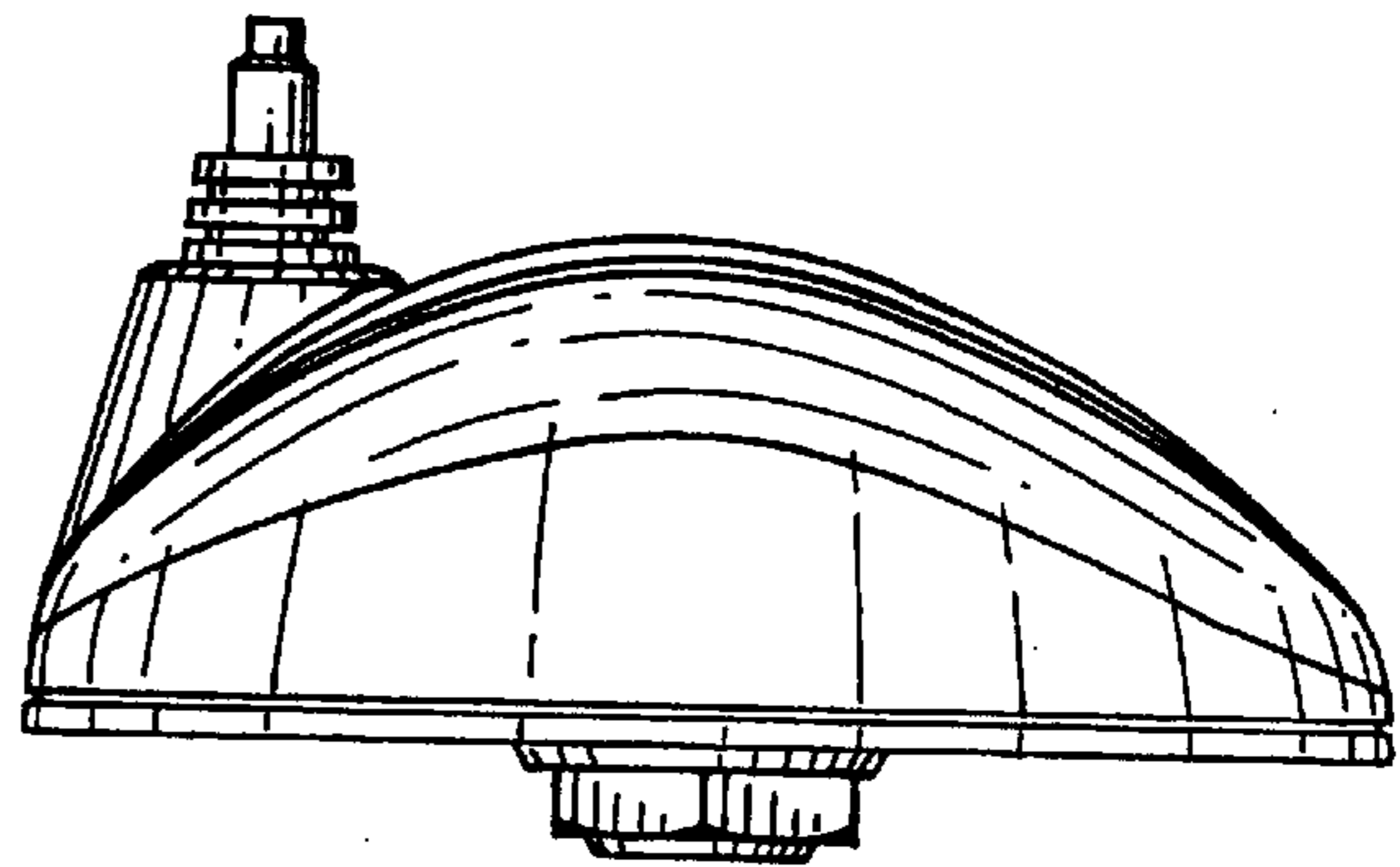
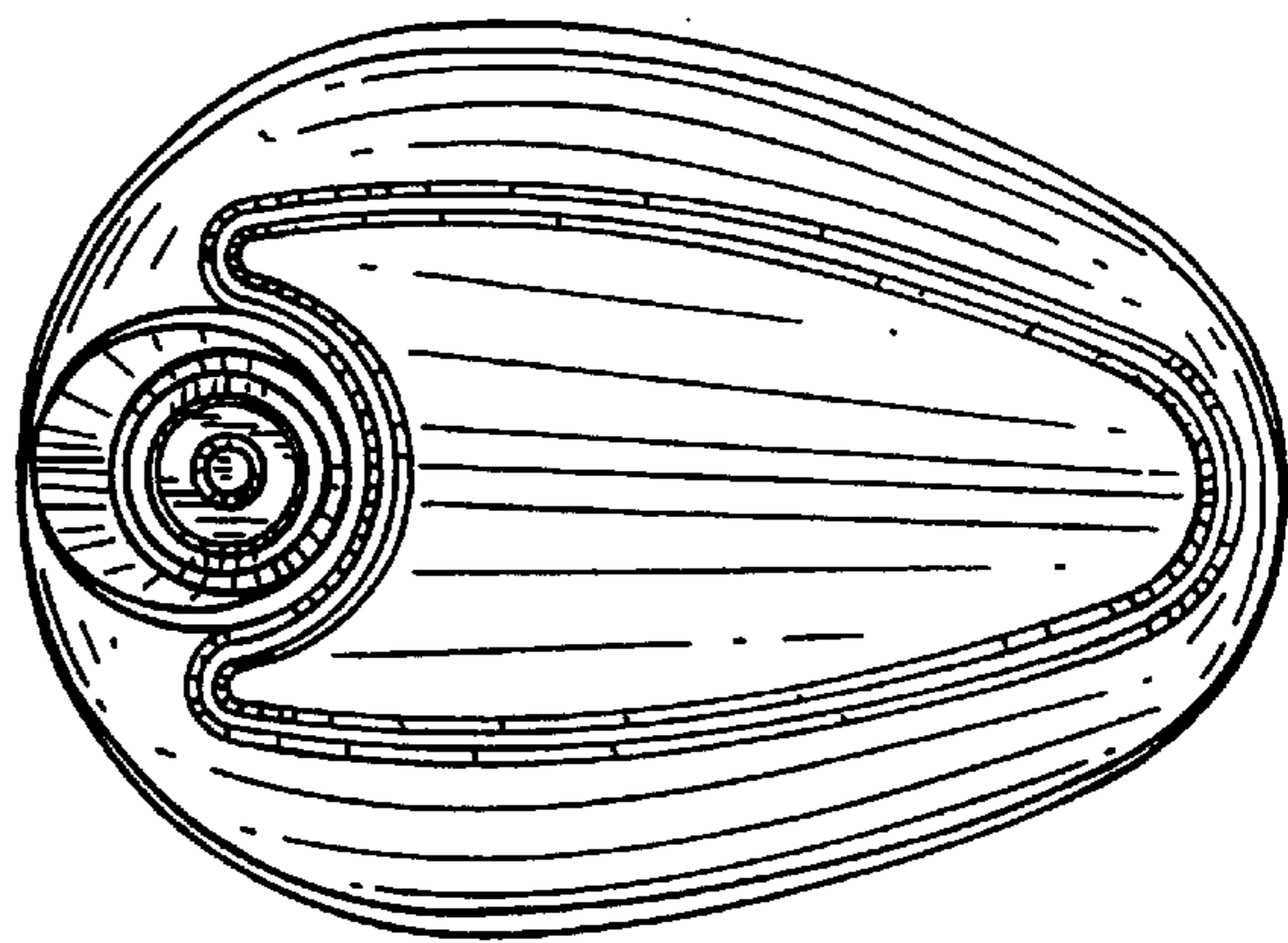

FIG. 11

FIG. 12



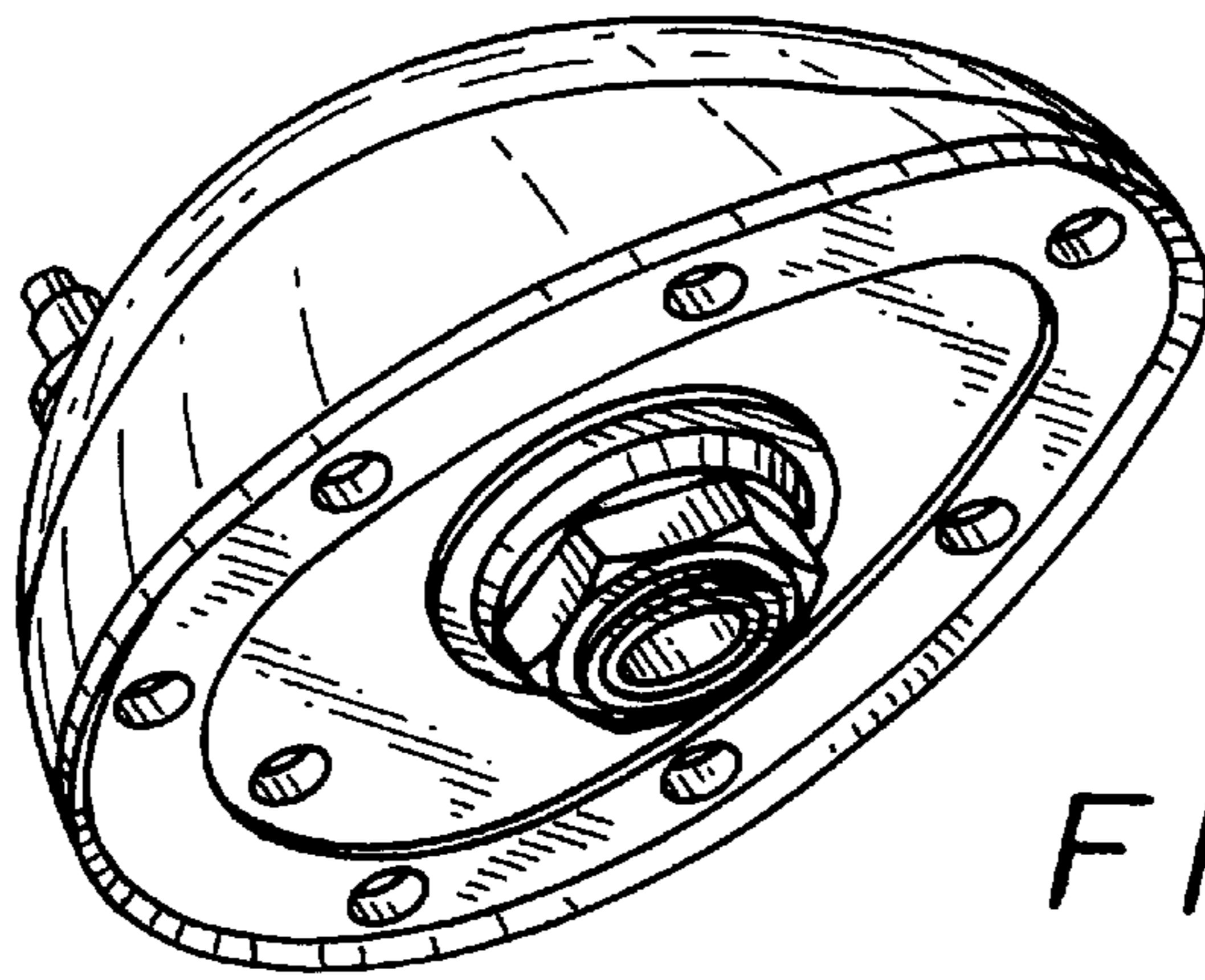

FIG. 13

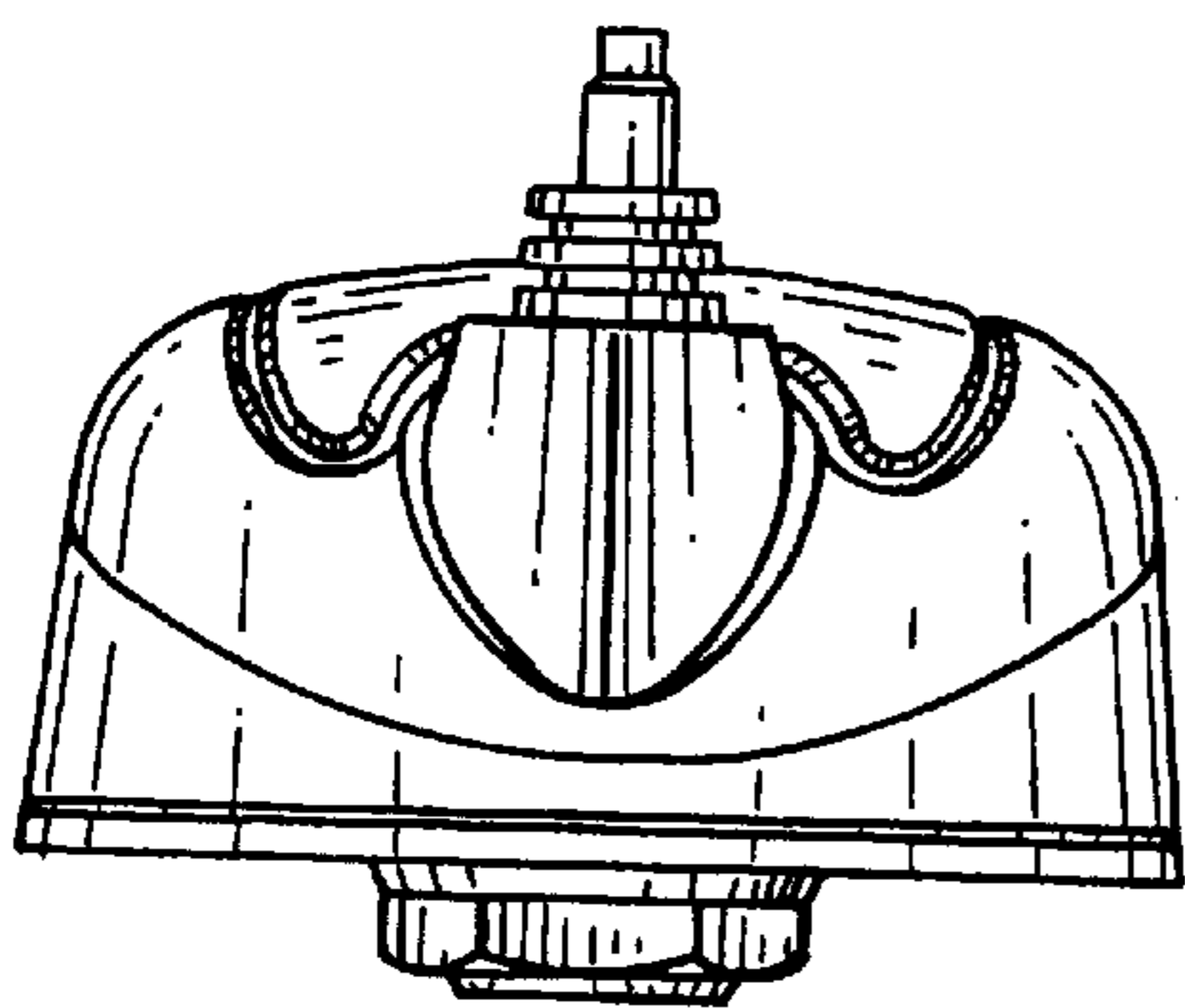

FIG. 14

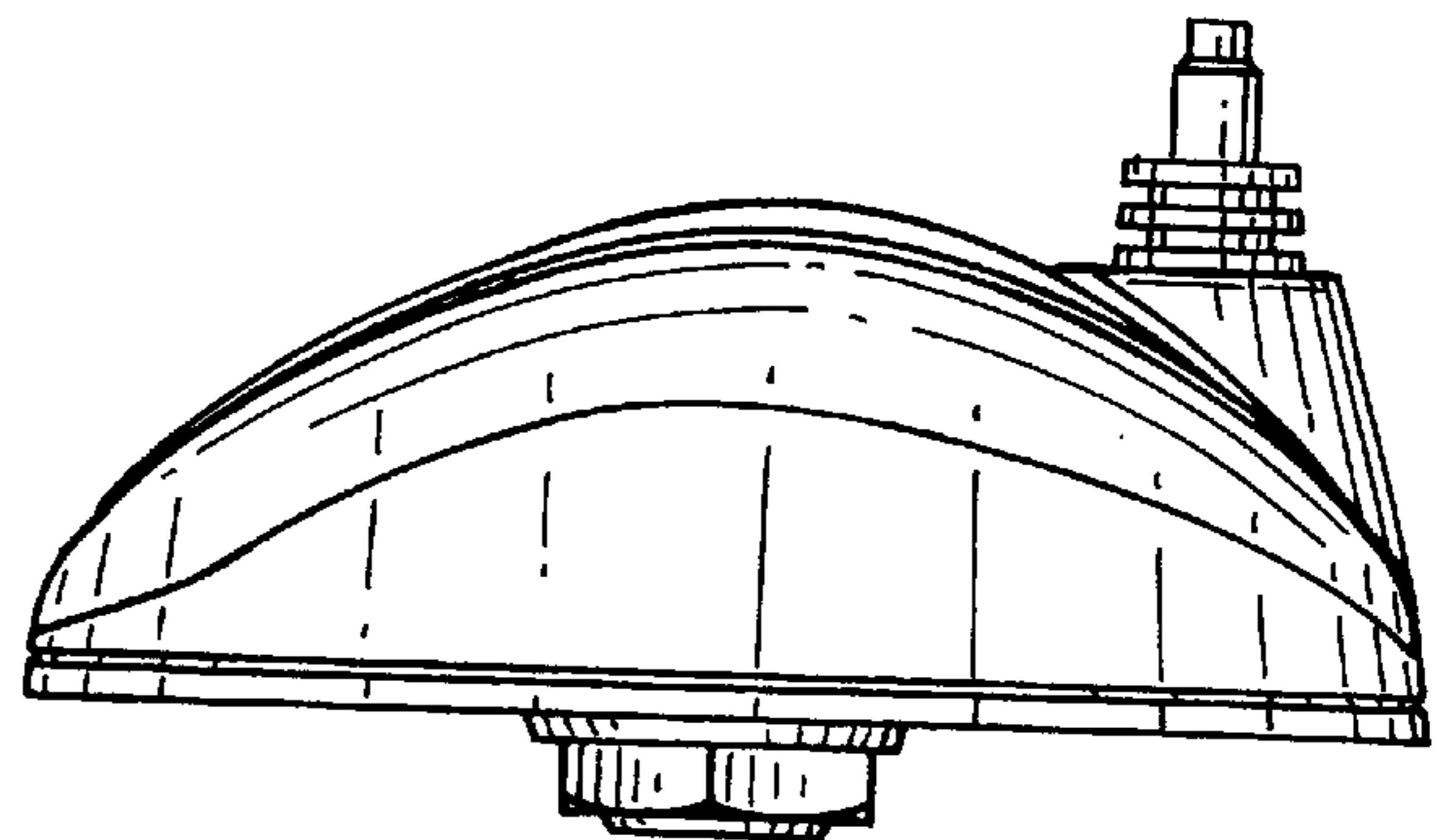

FIG. 15

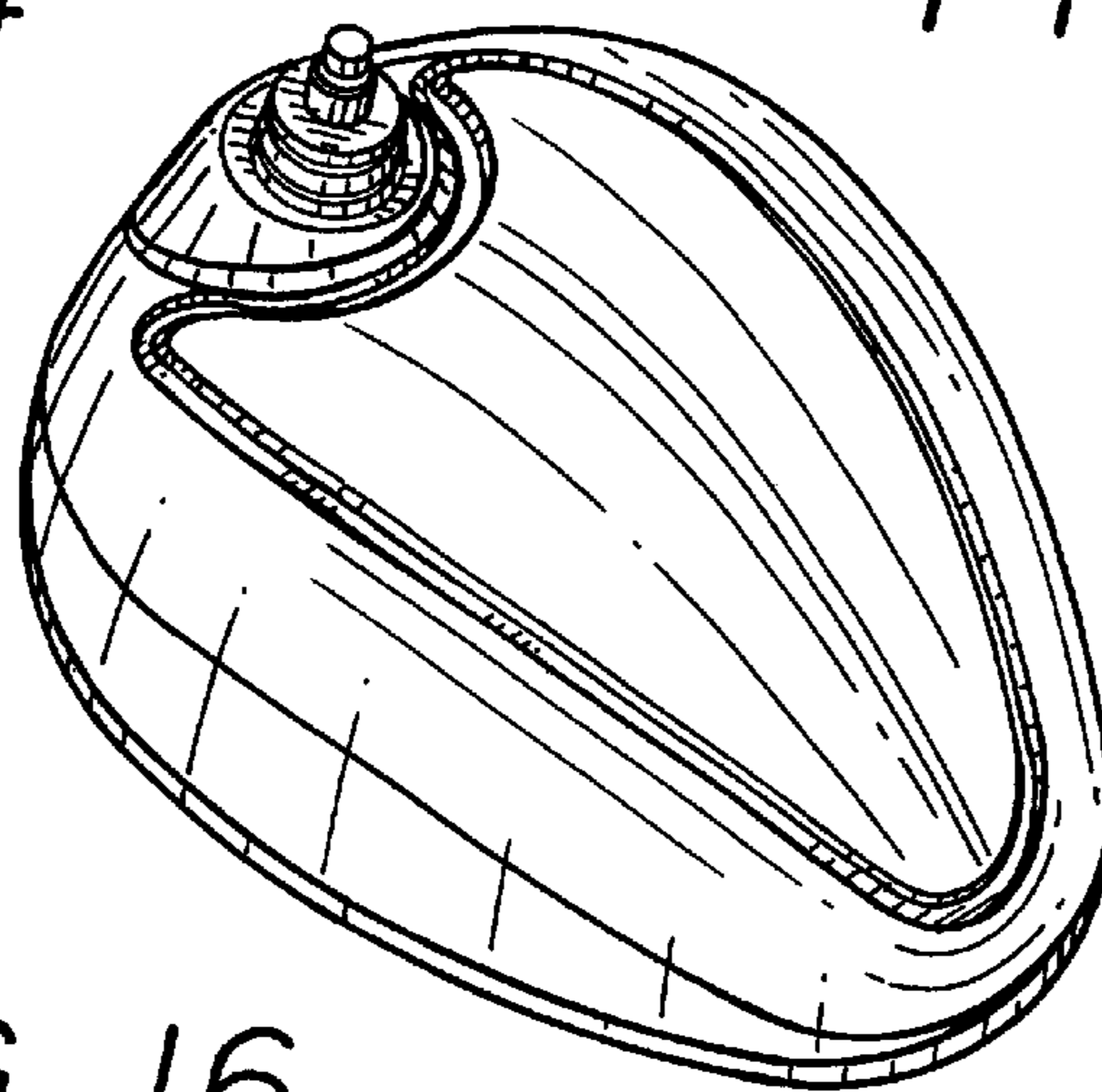

FIG. 16

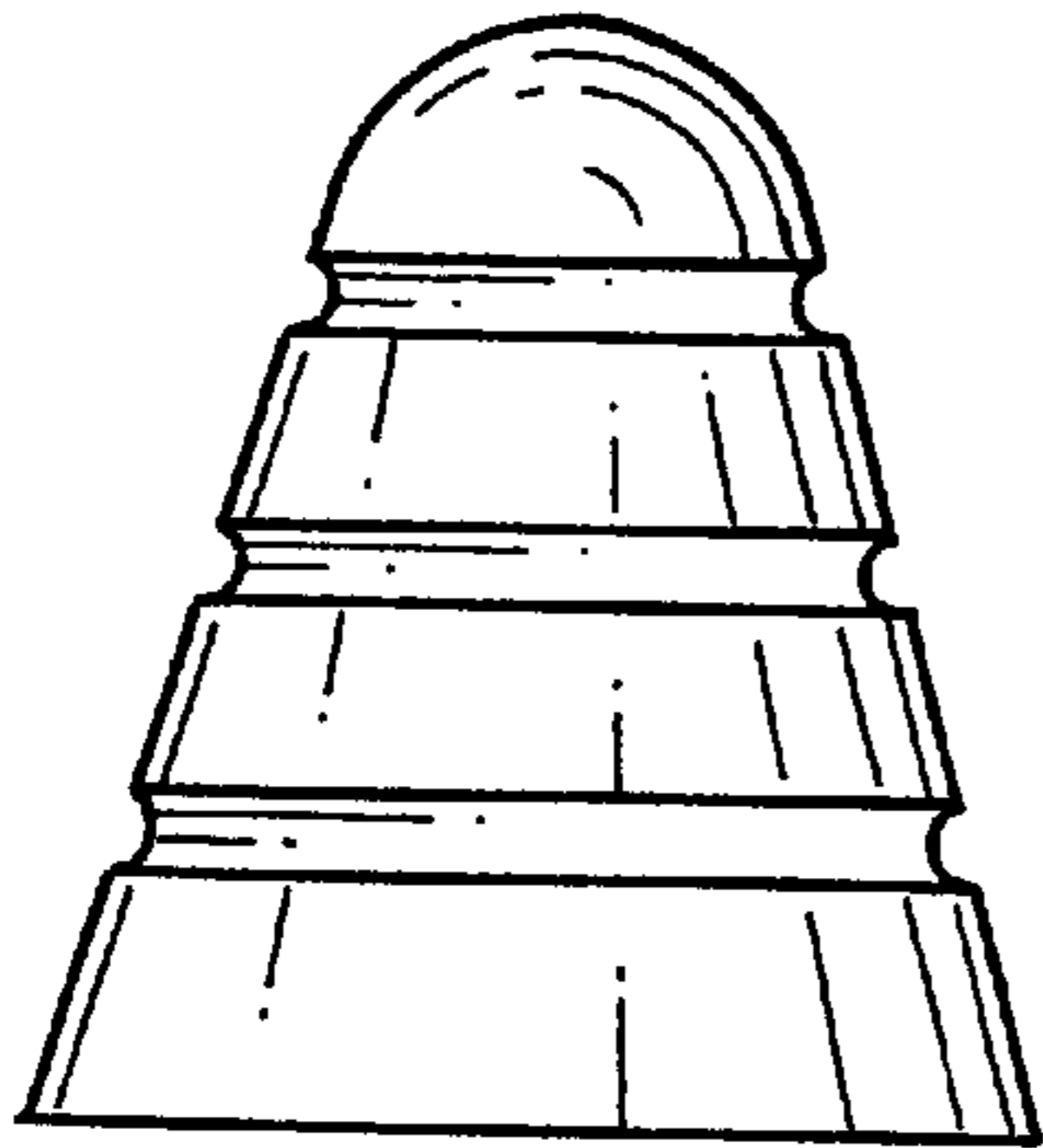

FIG. 17

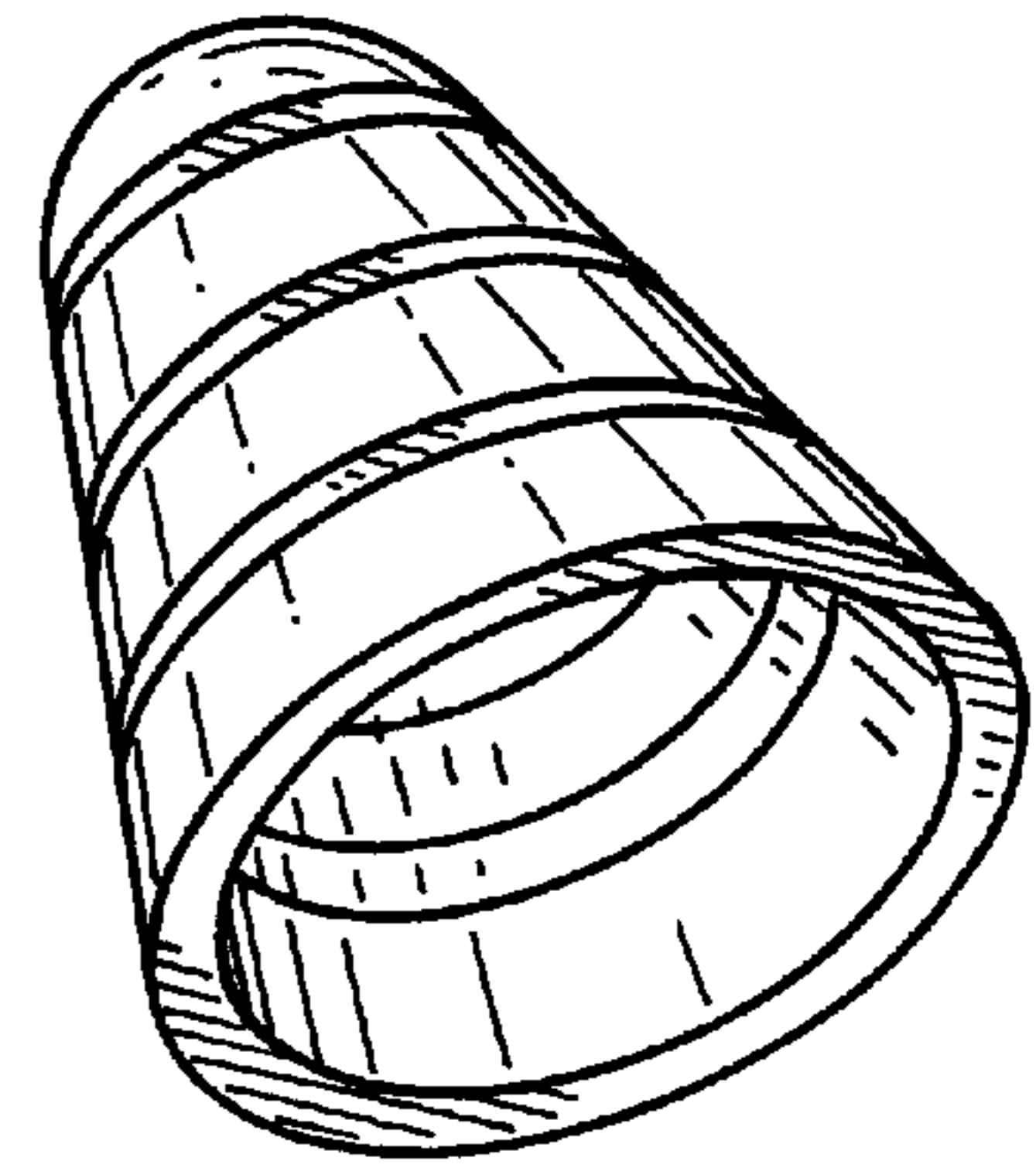

FIG. 18

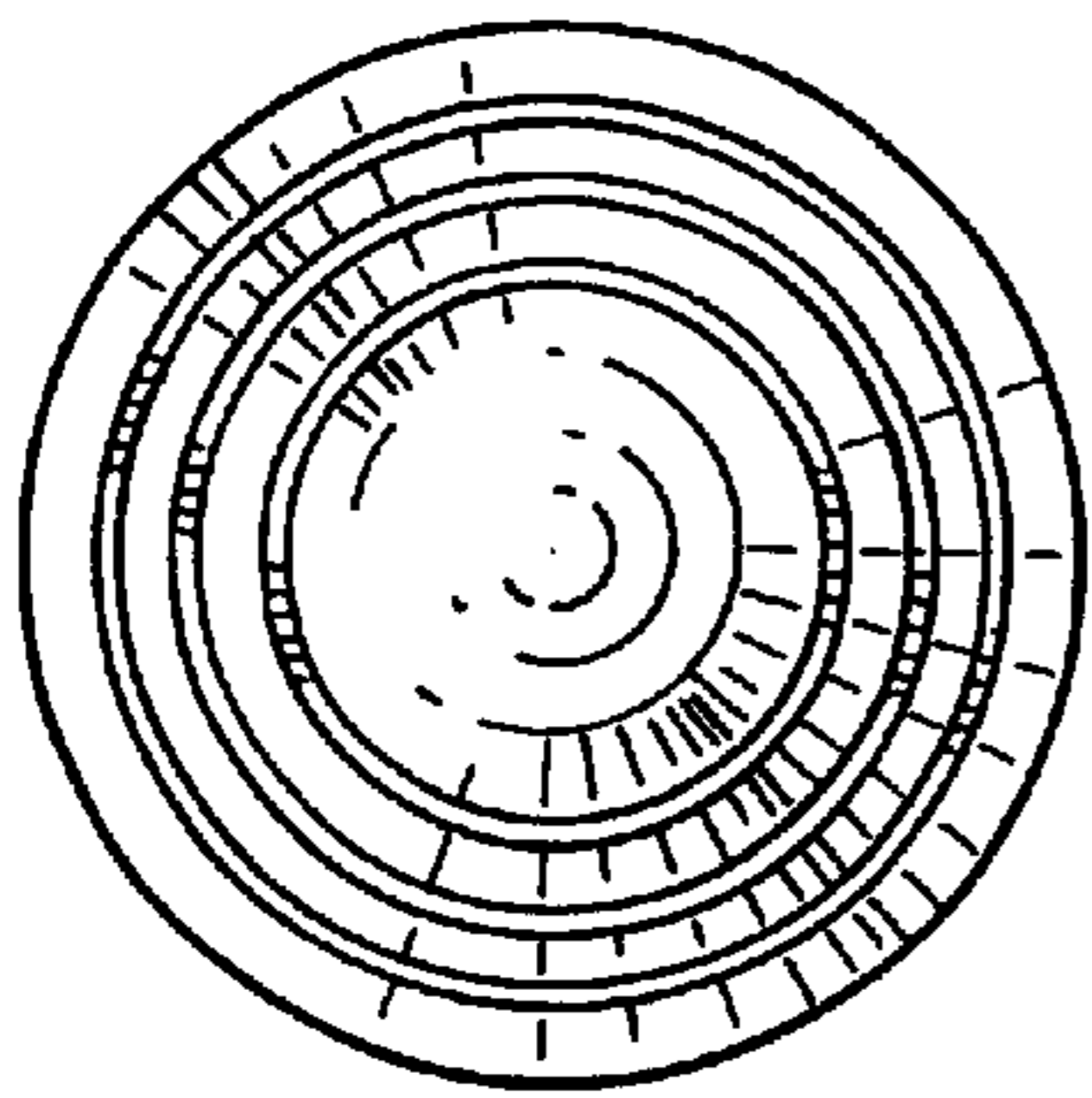

FIG. 19

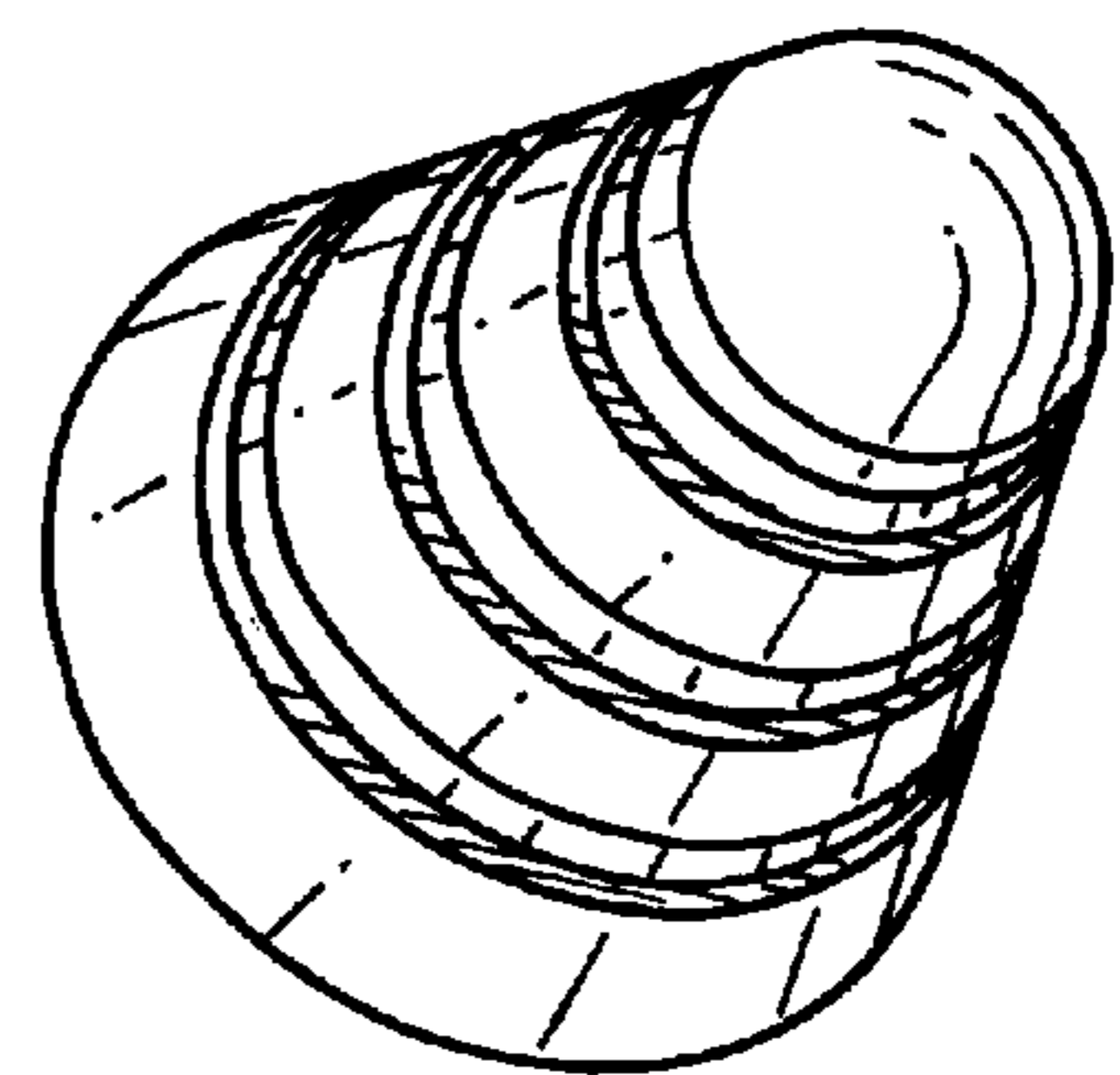

FIG. 20