



US00D443095S

(12) **United States Design Patent**
McMahon

(10) **Patent No.:** **US D443,095 S**

(45) **Date of Patent:** **** May 29, 2001**

(54) **LIGHTING FIXTURE**

(75) **Inventor:** **Joseph McMahon**, Marshfield, MA (US)

(73) **Assignee:** **M. Arthur Gensler, Jr. and Associates**, New York, NY (US)

(**) **Term:** **14 Years**

(21) **Appl. No.:** **29/112,924**

(22) **Filed:** **Oct. 26, 1999**

(51) **LOC (7) Cl.** **26-05**

(52) **U.S. Cl.** **D26/76; D26/81**

(58) **Field of Search** **D26/75-78; 362/216, 362/217, 218, 219, 220, 221, 222, 223, 224, 225**

(56) **References Cited**

U.S. PATENT DOCUMENTS

D. 122,236	*	8/1940	Scribner	D26/76
D. 125,927	*	3/1941	Parisson	D26/76
D. 129,836	*	10/1941	Koegel	D26/76
D. 148,695	*	2/1948	Guth et al.	D26/76
D. 169,999	*	7/1953	Ainsworth	D26/78
D. 294,067	*	2/1988	Ambaxz	D26/76
D. 311,781	*	10/1990	Usher	D26/72
4,924,366	*	5/1990	Shemitz	362/249
5,848,833	*	12/1998	Margulies	362/147

* cited by examiner

Primary Examiner—Susan J. Lucas

(74) *Attorney, Agent, or Firm*—Schweitzer Cornman Gross & Bondell LLP

(57) **CLAIM**

I claim the ornamental design for a lighting fixture, as shown and described.

DESCRIPTION

FIG. 1 is a top view of the lighting fixture;
FIG. 2 is a side elevation view;
FIG. 3 is an end elevation view thereof, the opposite end being identical;

FIG. 4 is a bottom plan view thereof;
FIG. 5 is a top plan view of a second embodiment of the lighting fixture;
FIG. 6 is a side elevation view thereof;
FIG. 7 is a end elevation view thereof, the opposite end being a mirror image;
FIG. 8 is a bottom plan view;
FIG. 9 is a top plan view of third embodiment of the lighting fixture;
FIG. 10 is a side elevation view thereof;
FIG. 11 is an end elevation view thereof;
FIG. 12 is a bottom plan view thereof;
FIG. 13 is a top plan view of a fourth embodiment of the lighting fixture;
FIG. 14 is a side elevation view thereof;
FIG. 15 is an end elevation view, the opposite end being identical;
FIG. 16 is a bottom plan view thereof;
FIG. 17 is a top plan view of a fifth embodiment of the lighting fixture;
FIG. 18 is a side elevation view thereof;
FIG. 19 is an end elevation view thereof, the opposite end being identical;
FIG. 20 is a bottom plan view;
FIG. 21 is a top plan view of a sixth embodiment of the lighting fixture;
FIG. 22 is a side view thereof;
FIG. 23 is an end view;
FIG. 24 is a bottom view;
FIG. 25 is a top plan view of a seventh embodiment of the lighting fixture;
FIG. 26 is a side view thereof;
FIG. 27 is an end view thereof;
FIG. 28 is a bottom plan view;
FIG. 29 is a top view of an eighth embodiment of the lighting fixture;
FIG. 30 is a side view;
FIG. 31 is an end view, the opposite end being identical;
FIG. 32 is a bottom plan view;
FIG. 33 is a top plan view of a ninth embodiment of the lighting fixture;
FIG. 34 is a side view thereof, with all sides being identical; and,
FIG. 35 is a bottom plan view.

1 Claim, 9 Drawing Sheets

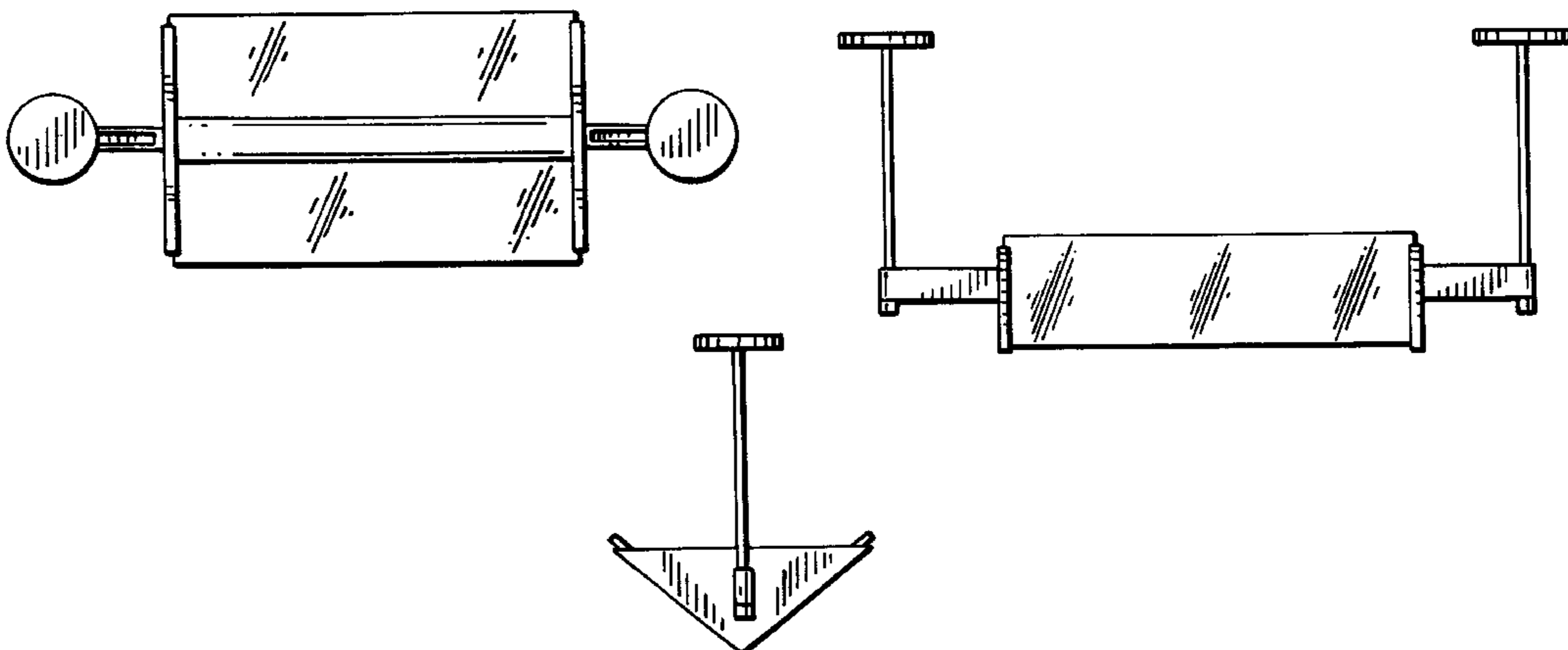

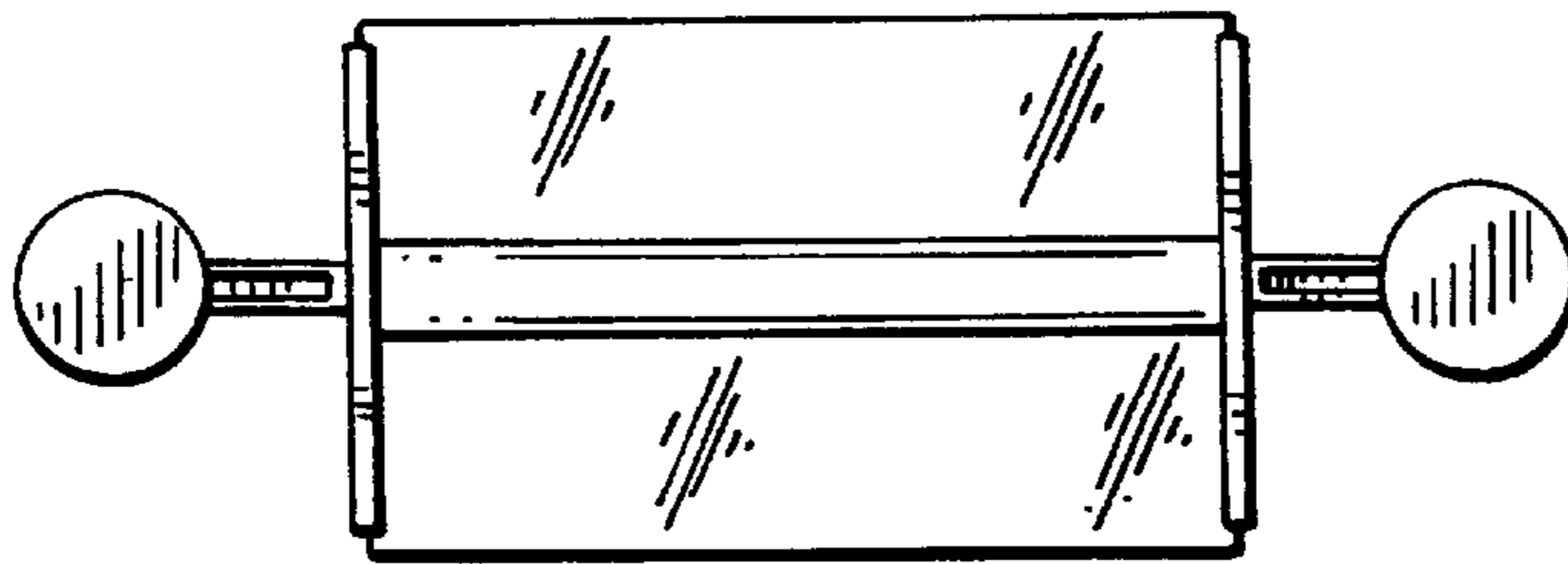

FIG. 1

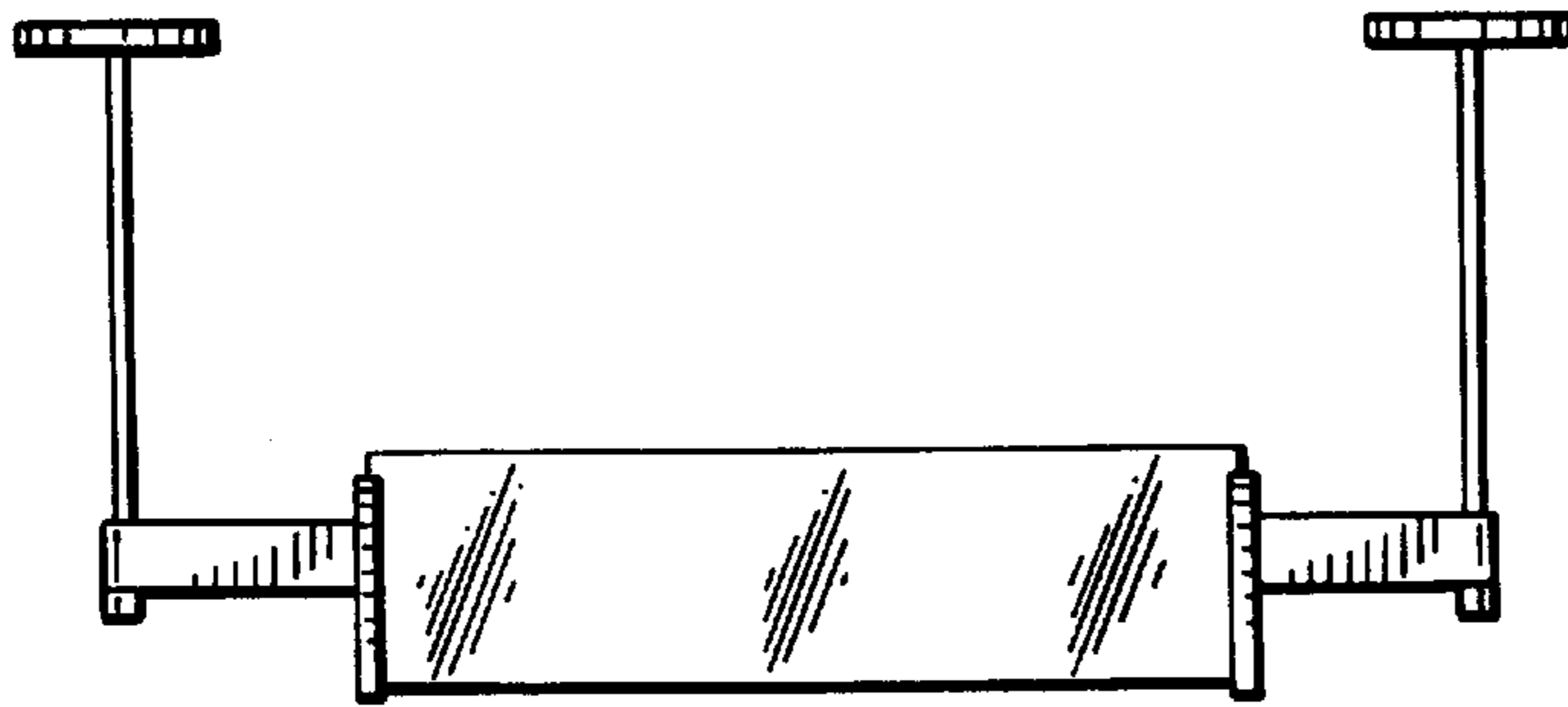

FIG. 2

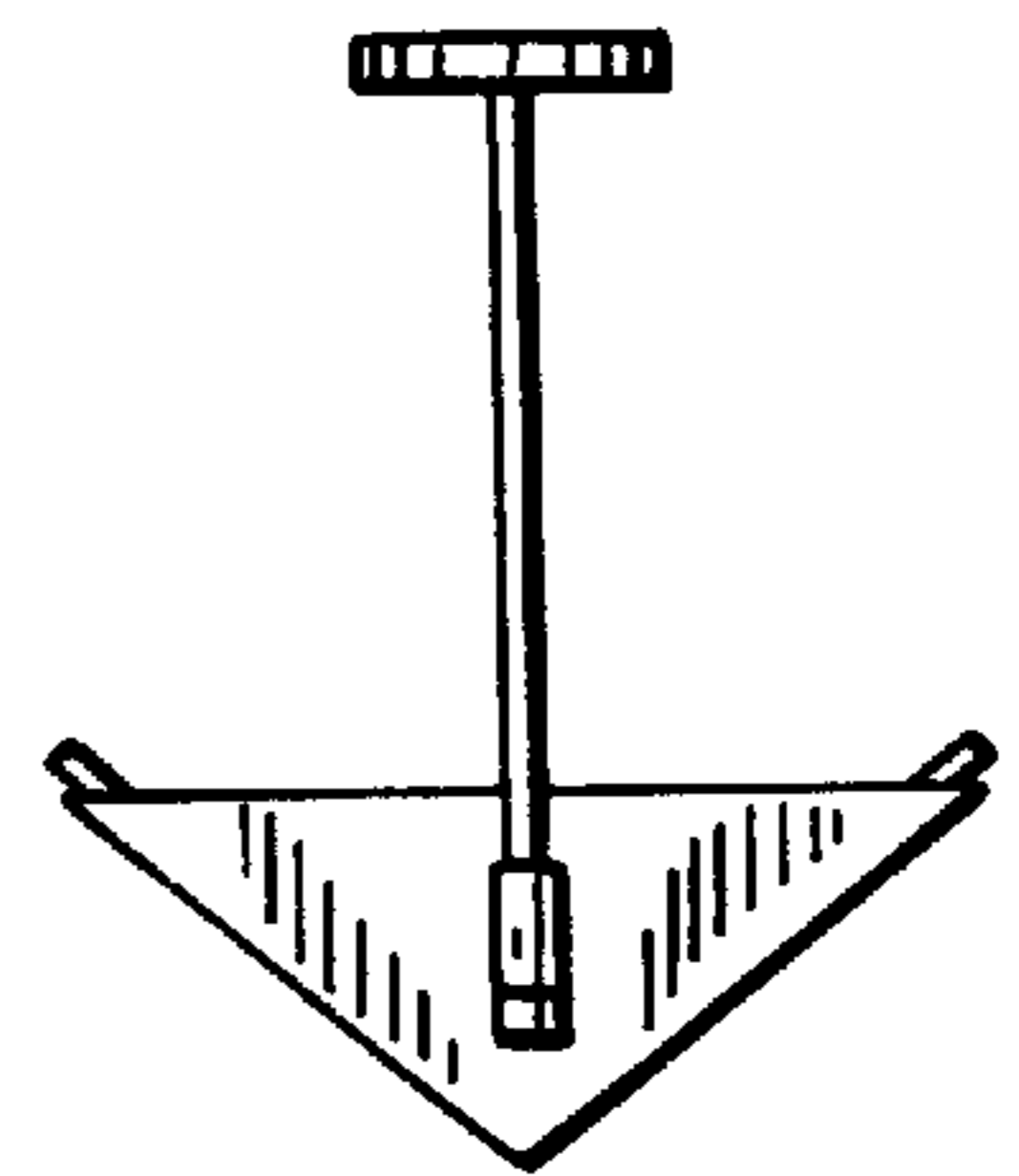

FIG. 3

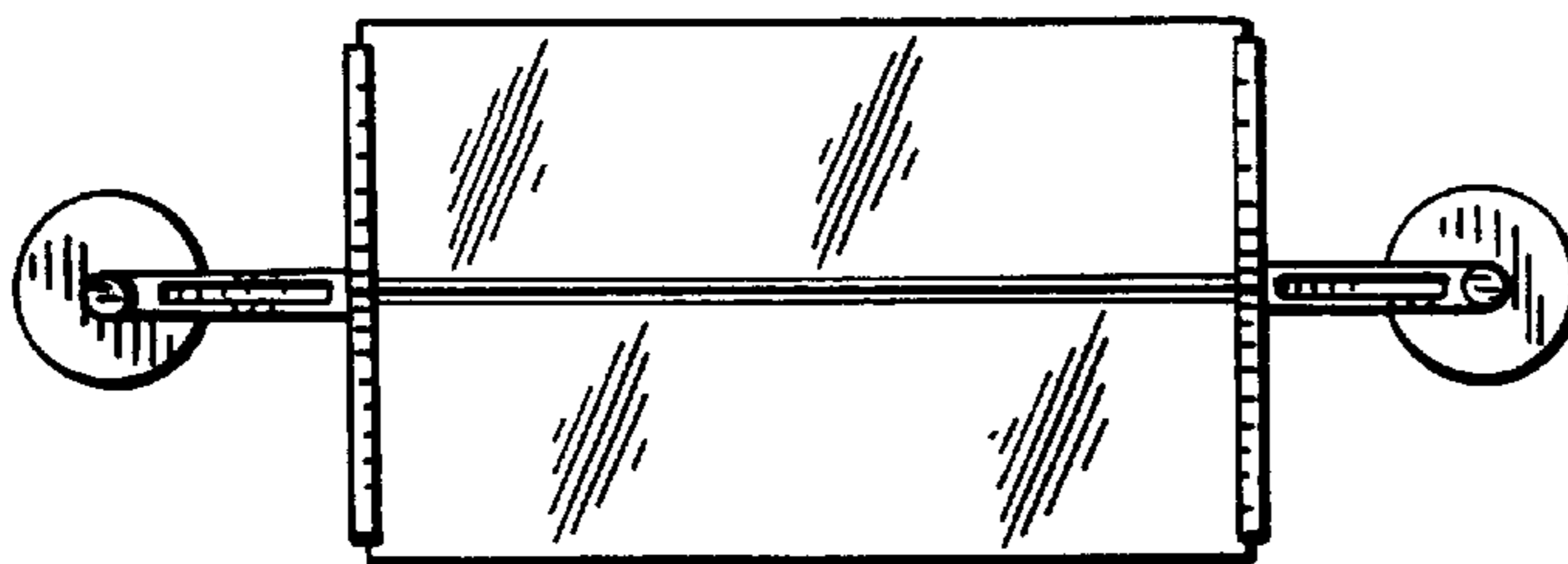

FIG. 4

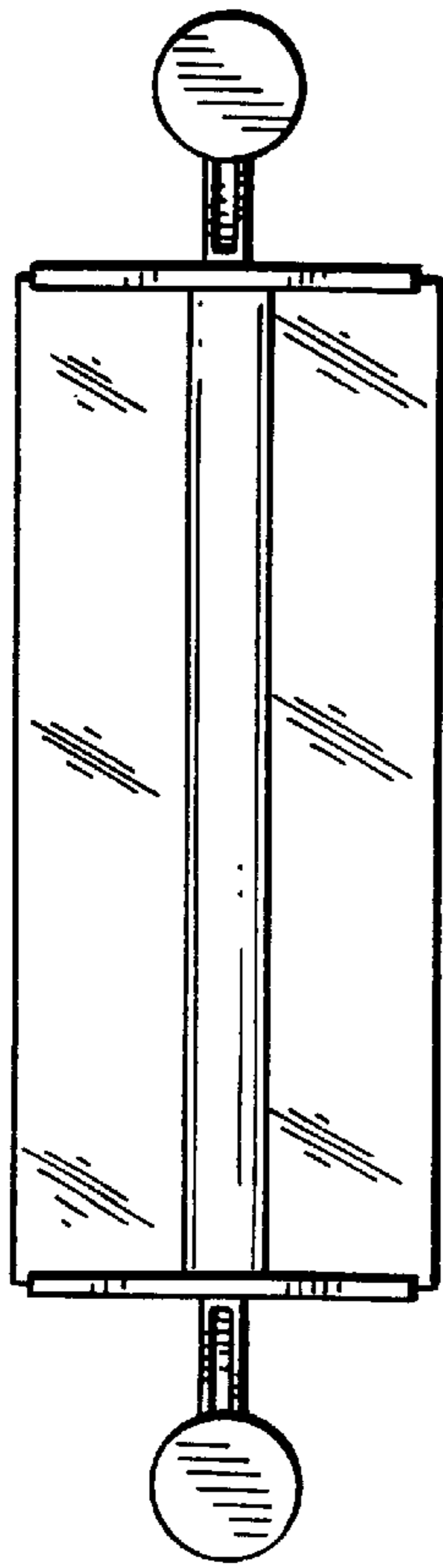

FIG. 5

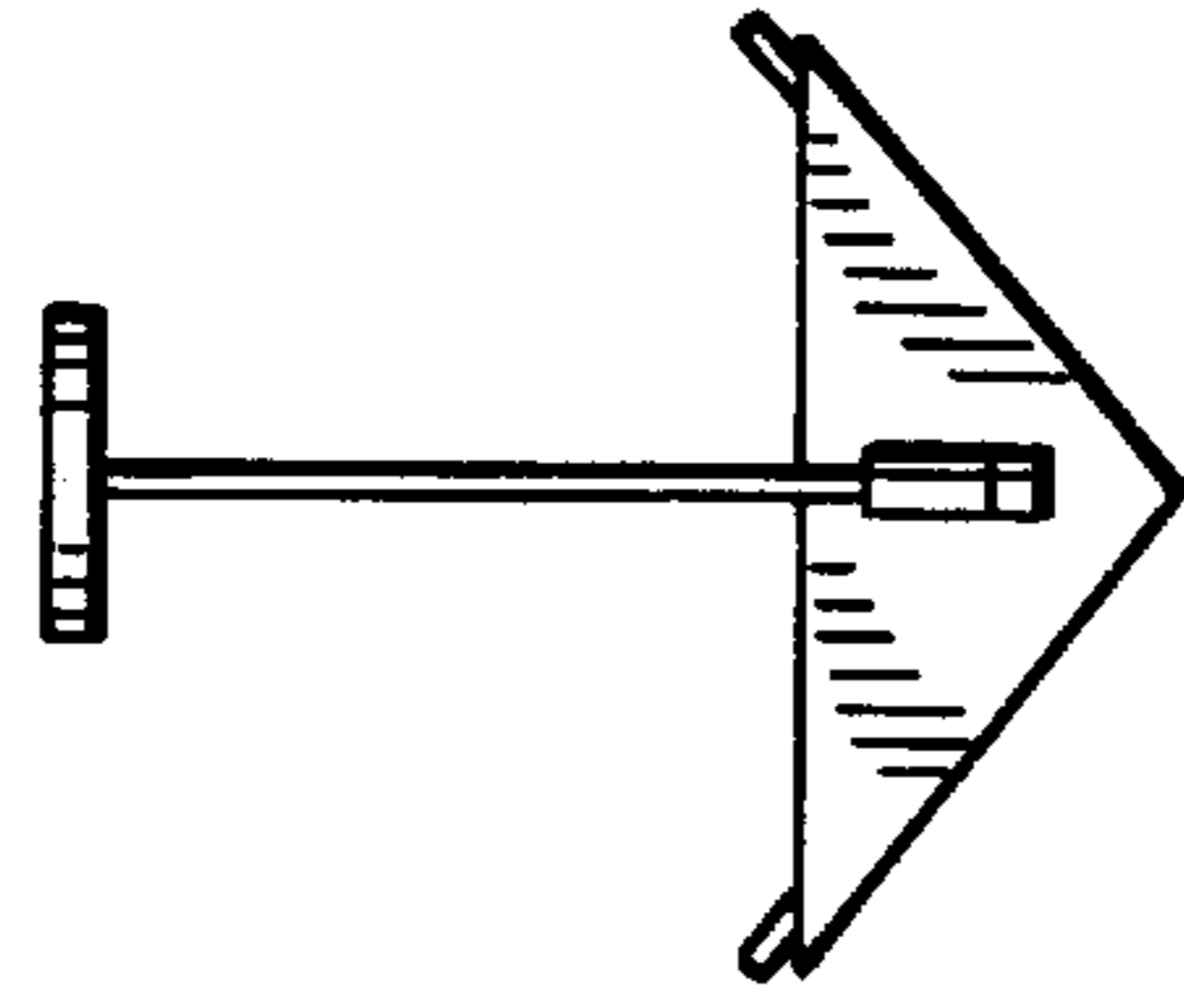

FIG. 7

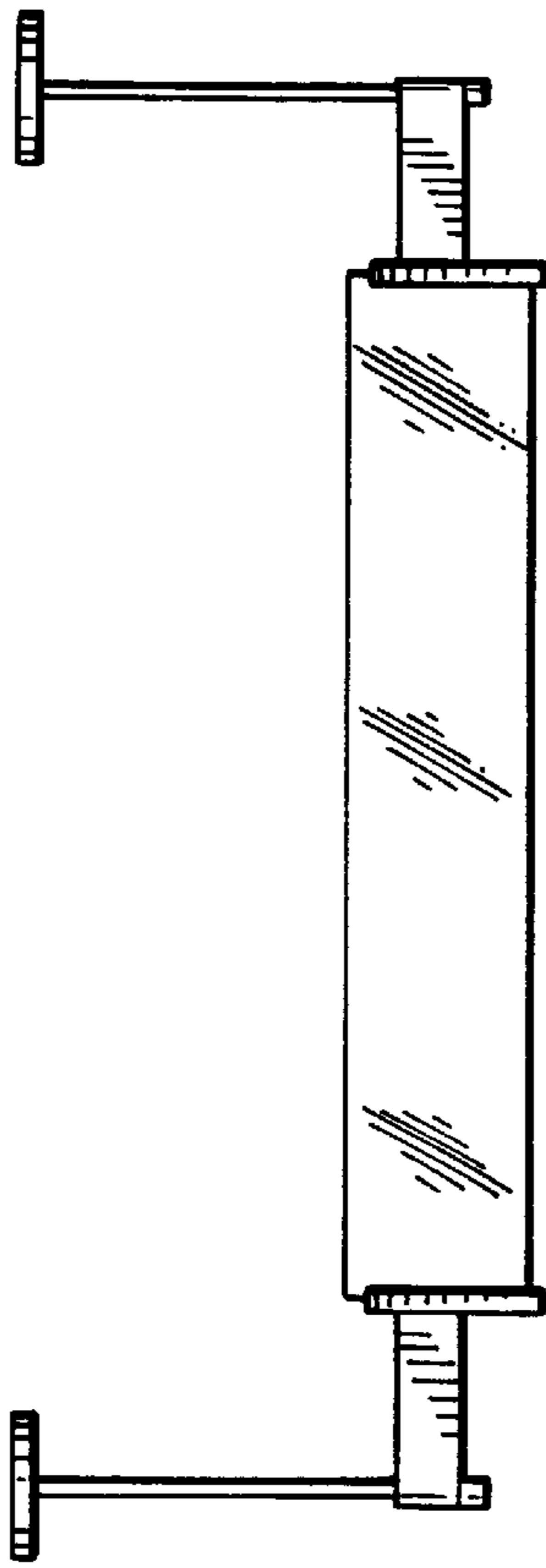

FIG. 6

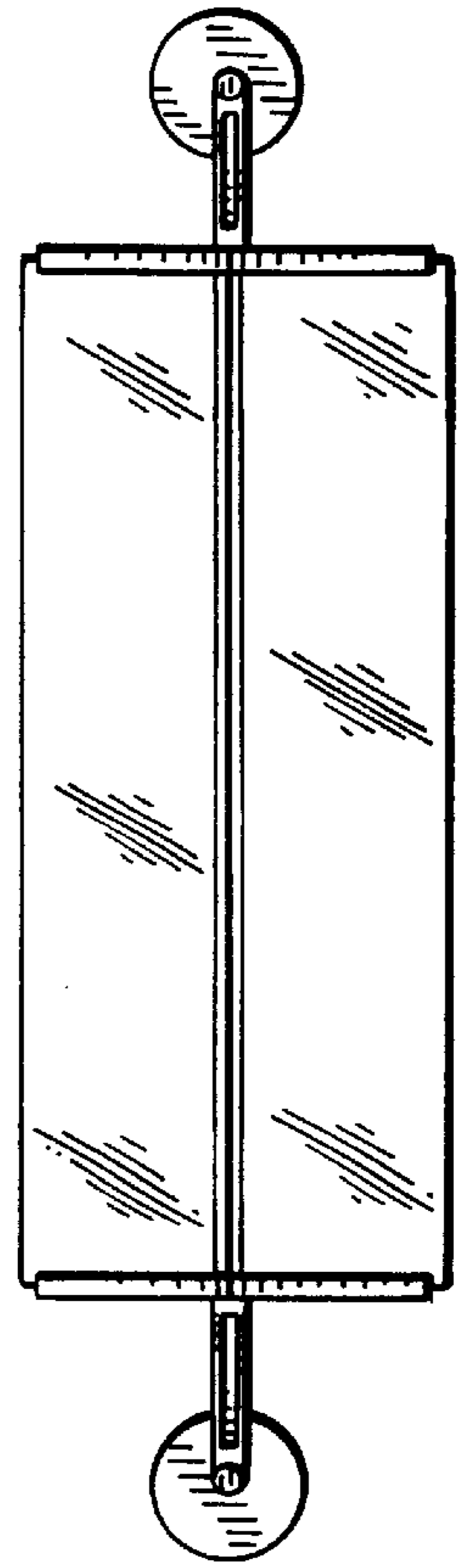

FIG. 8

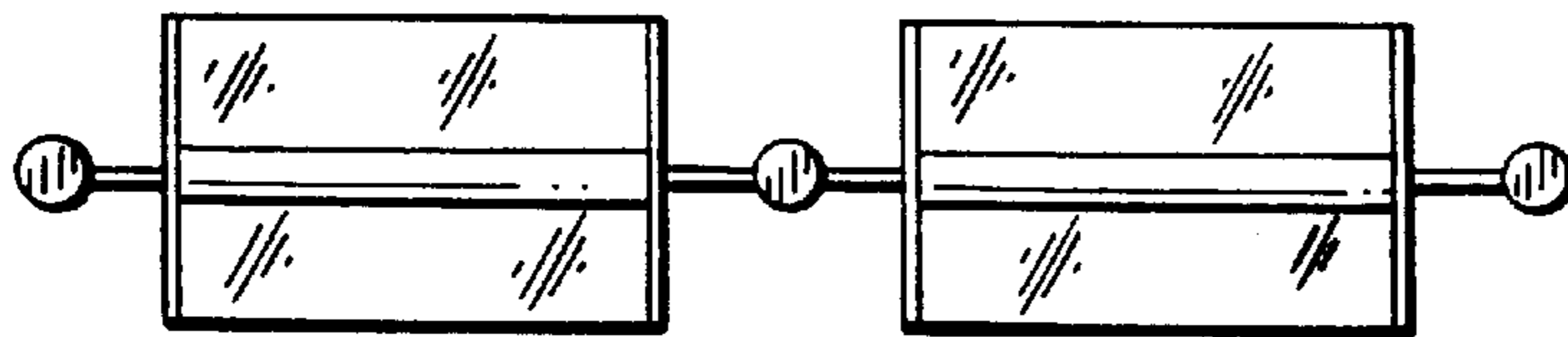

FIG. 9

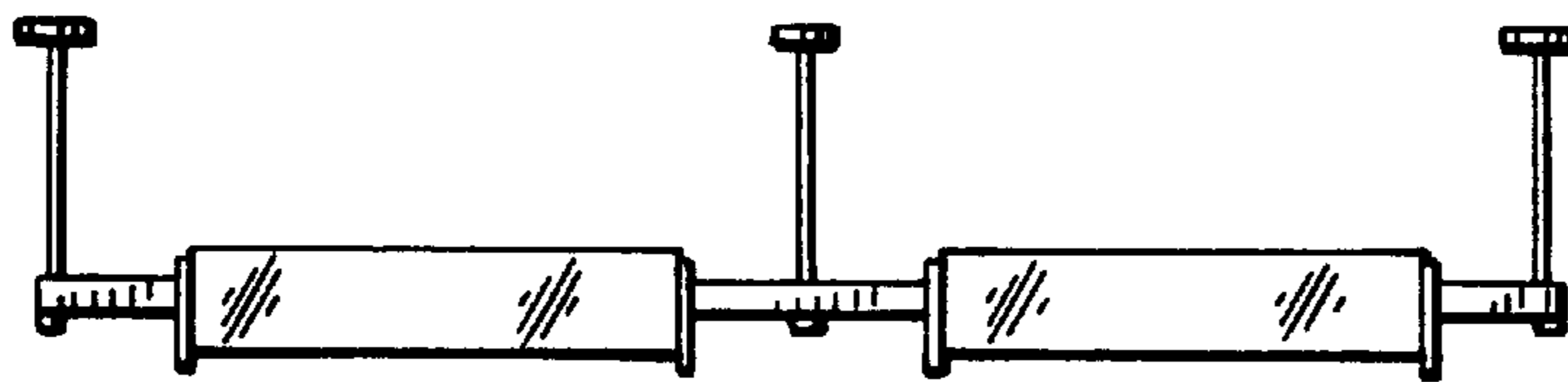

FIG. 10

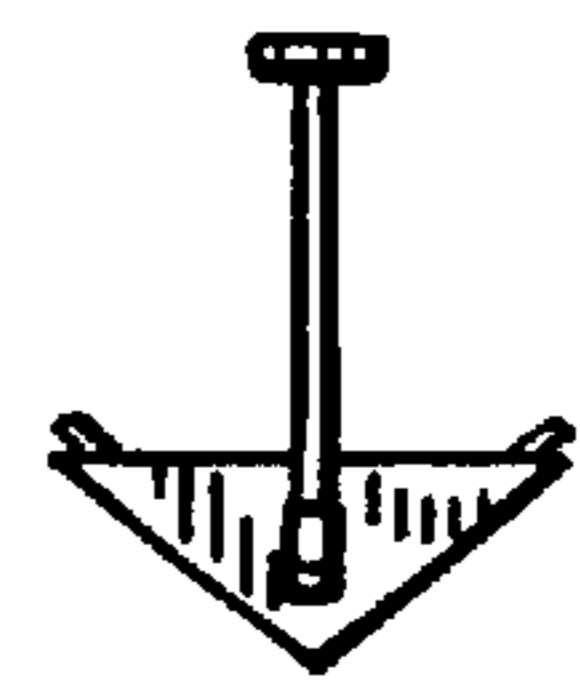

FIG. 11

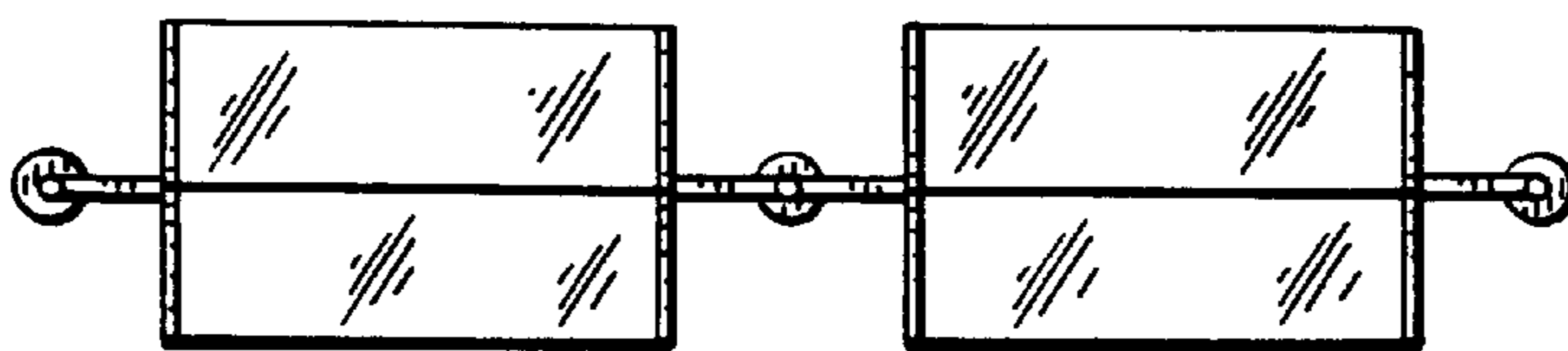

FIG. 12

FIG. 13

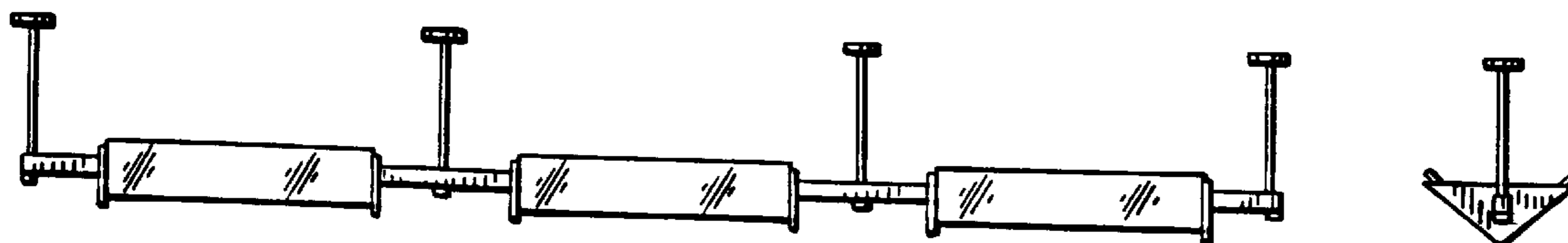
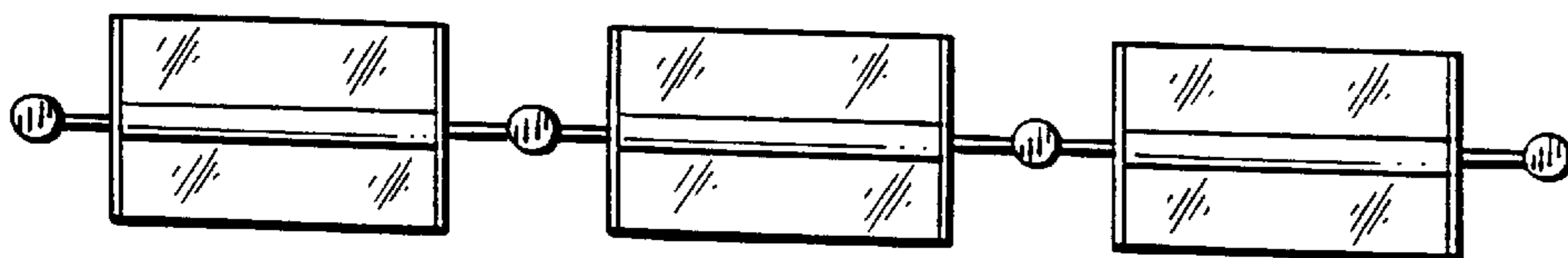

FIG. 14

FIG. 15

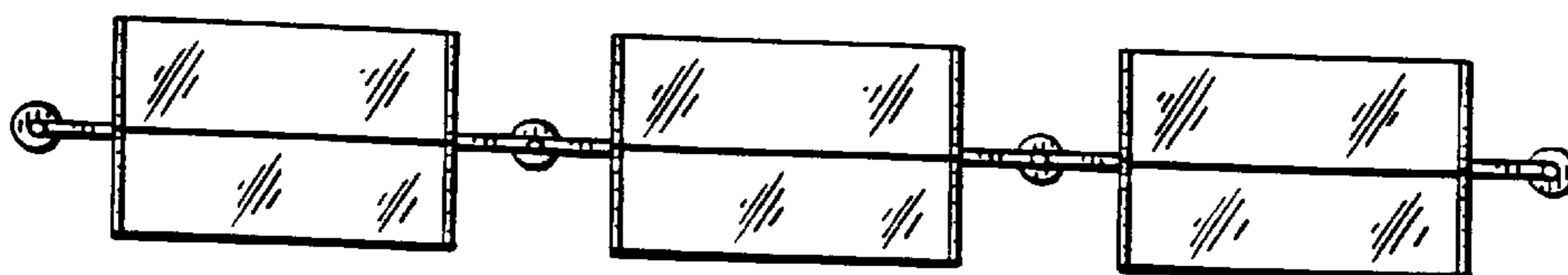

FIG. 16

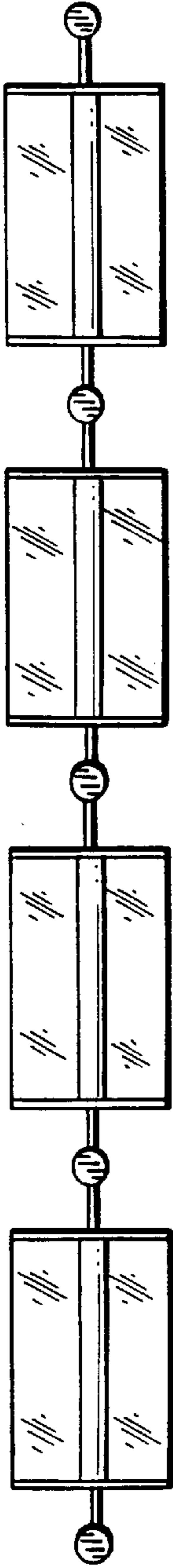

FIG. 17

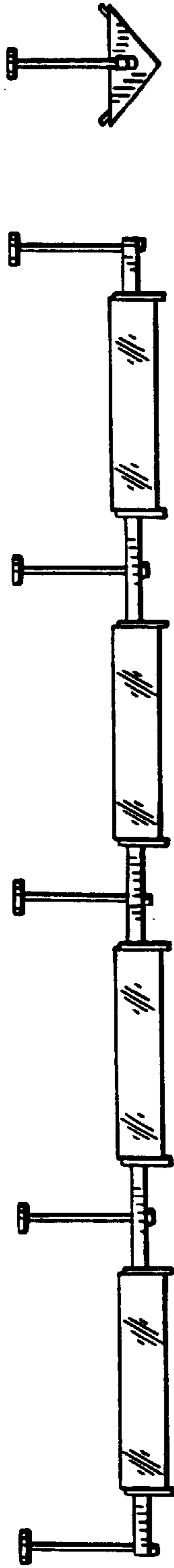
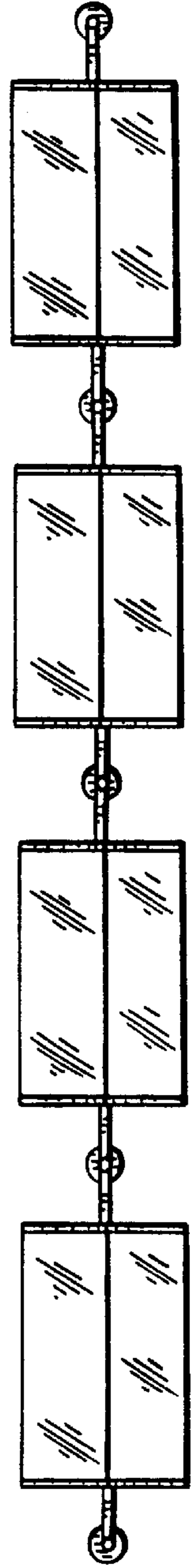

FIG. 18

FIG. 19

FIG. 20



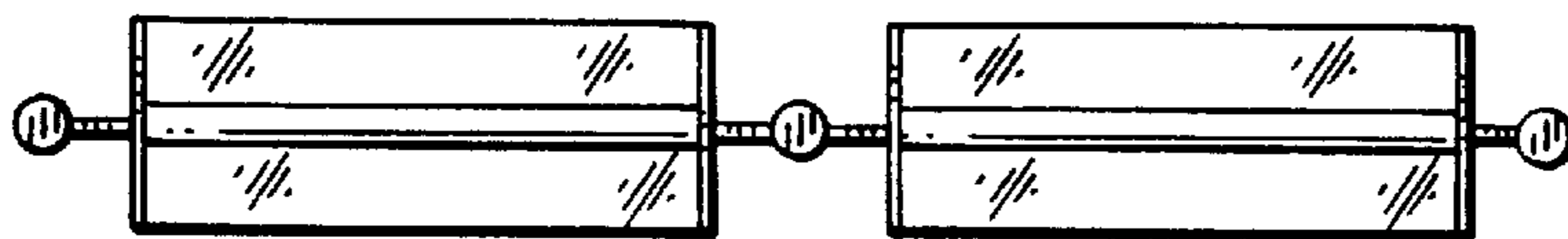

FIG. 21

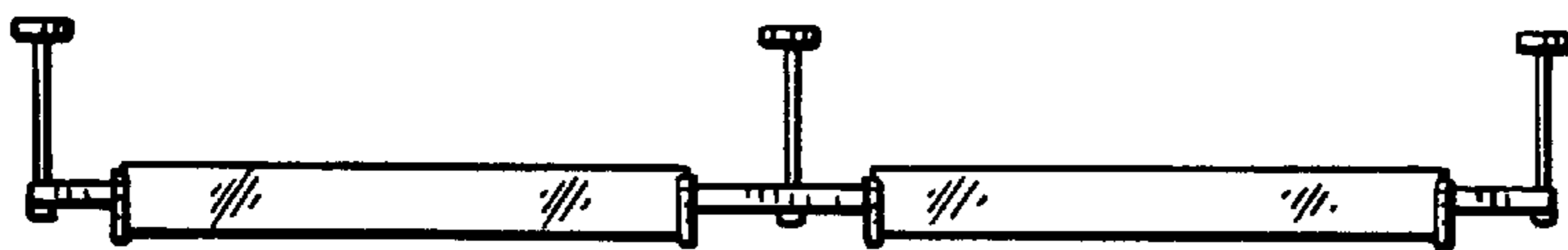

FIG. 22

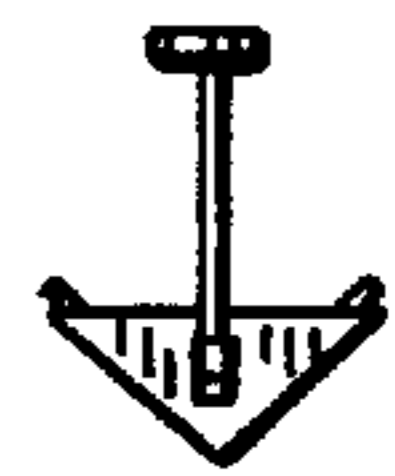

FIG. 23

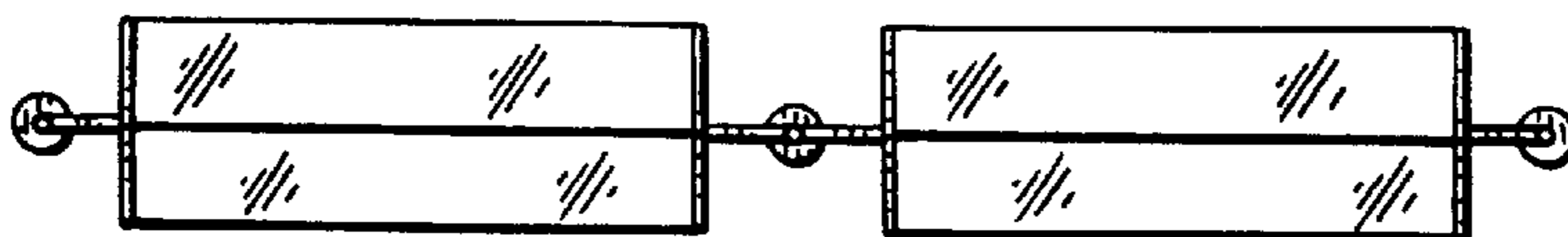

FIG. 24

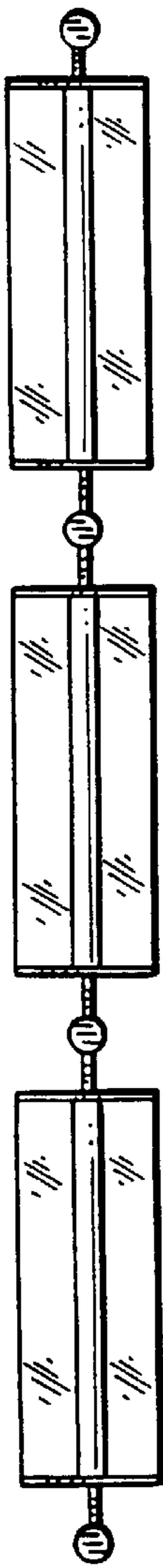

FIG. 25

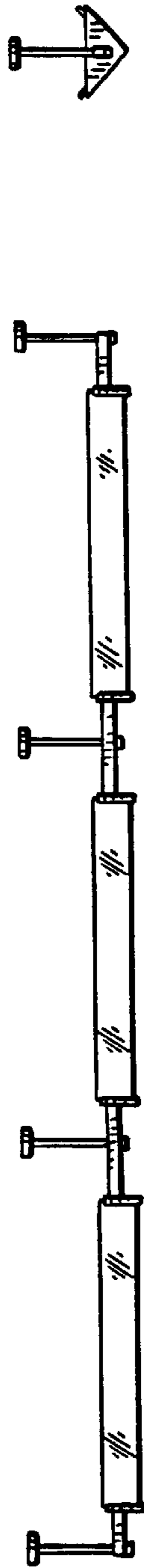

FIG. 27

FIG. 26

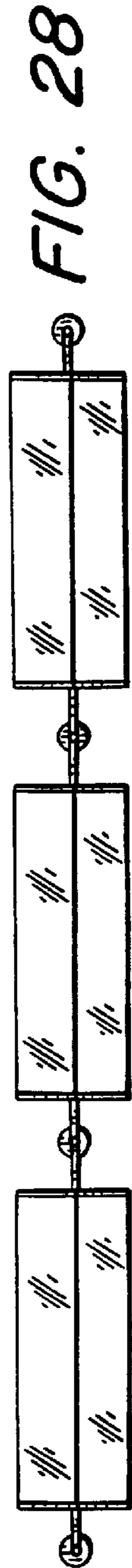

FIG. 28

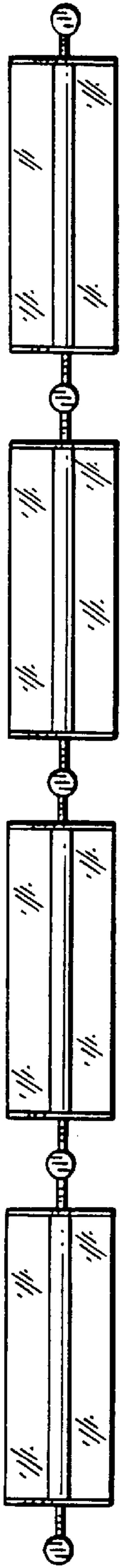

FIG. 29

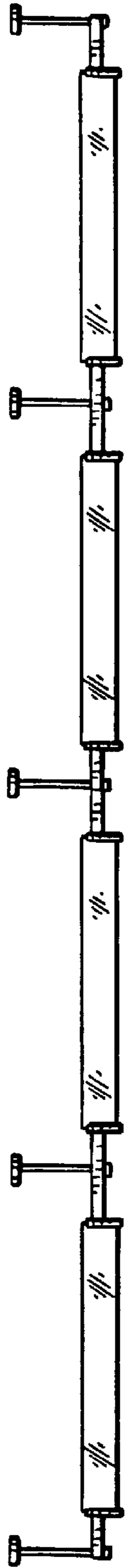

FIG. 30

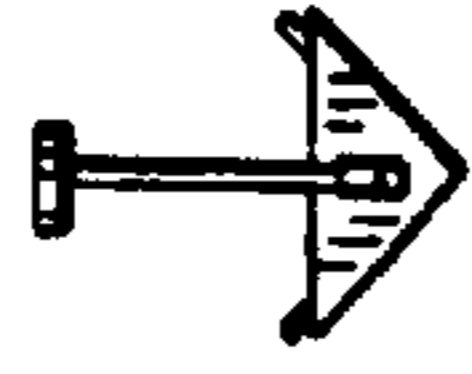

FIG. 31

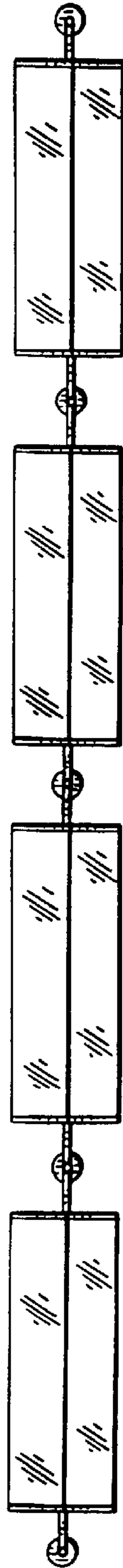

FIG. 32

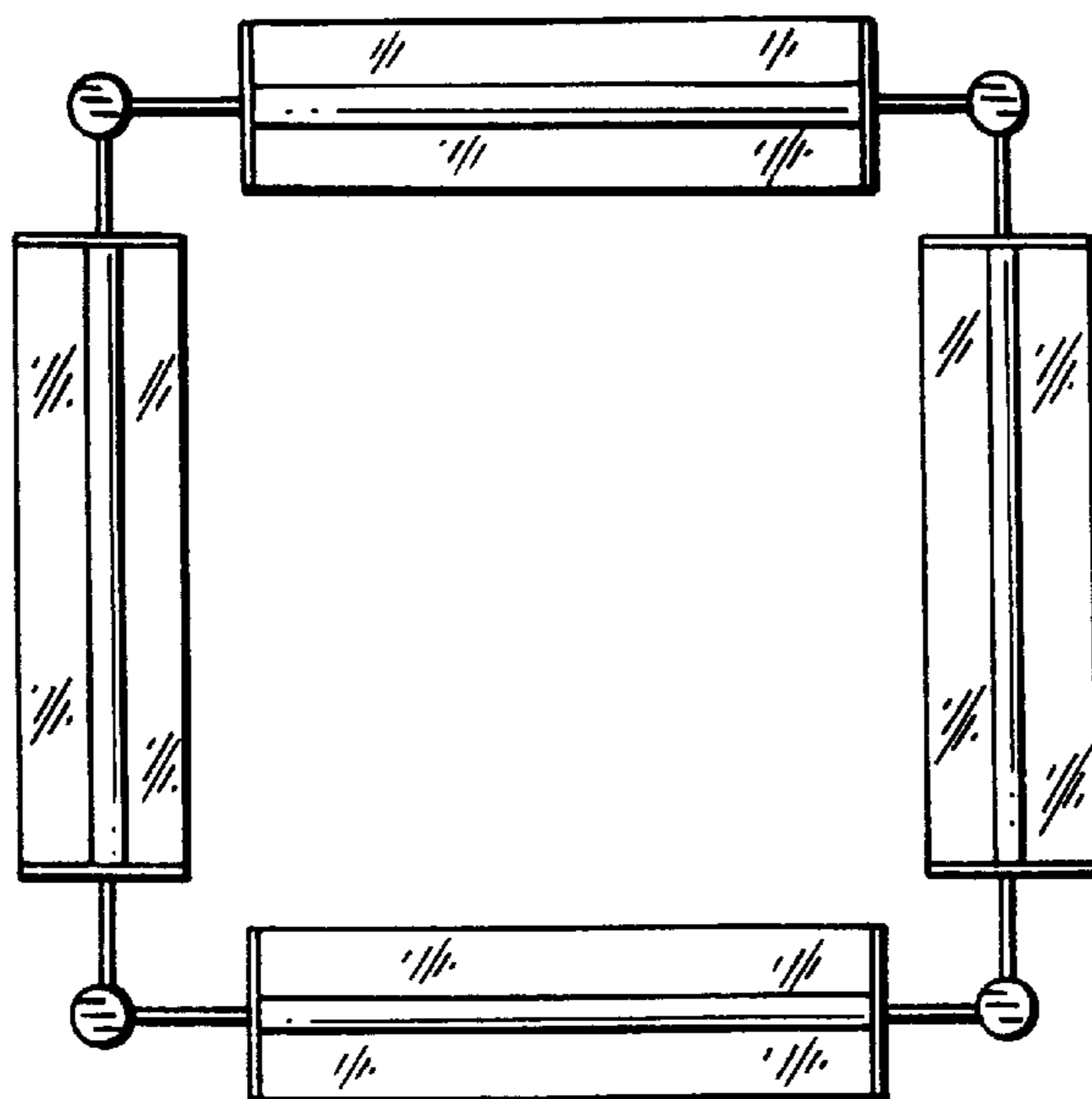

FIG. 33

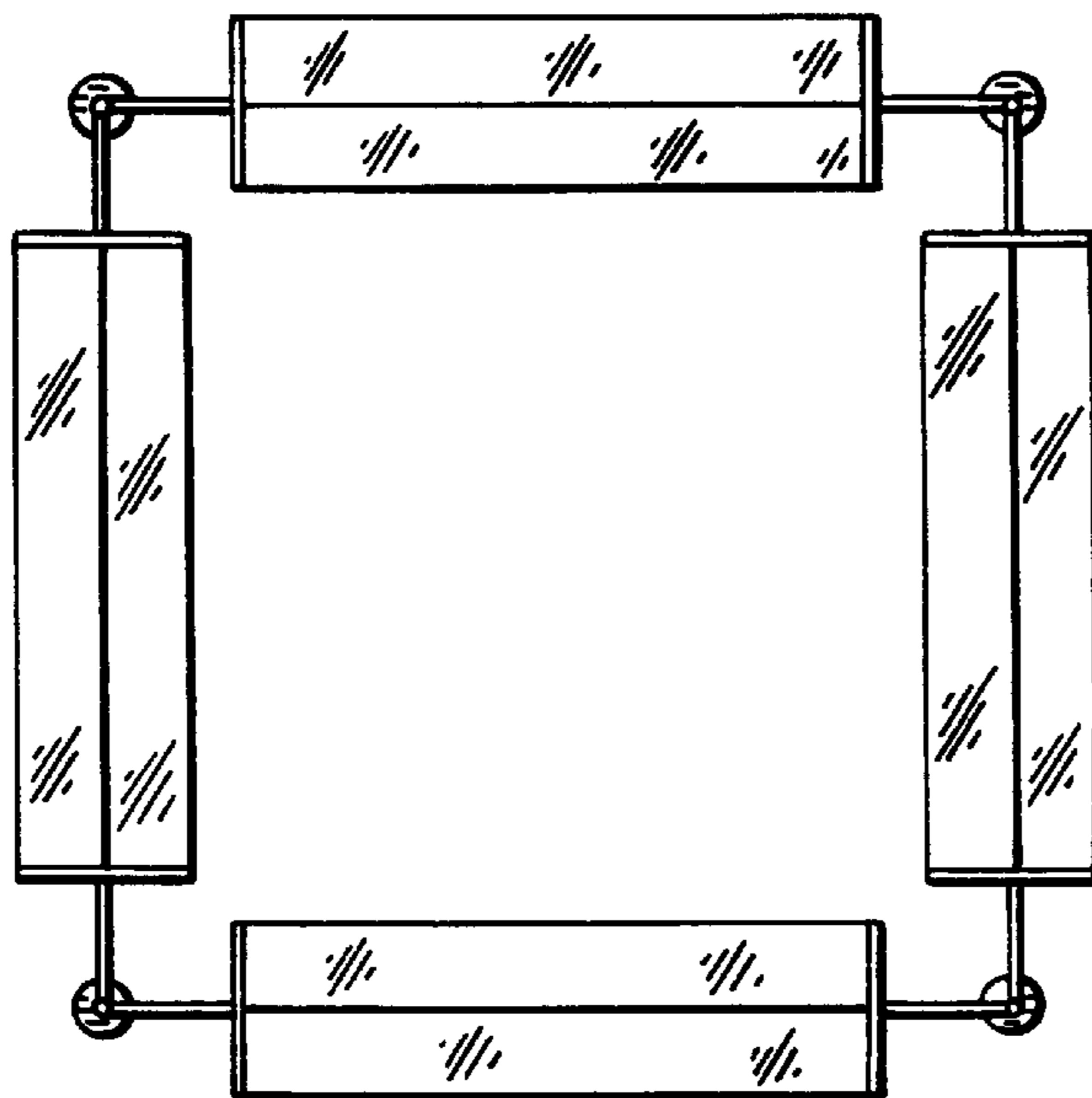

FIG. 35

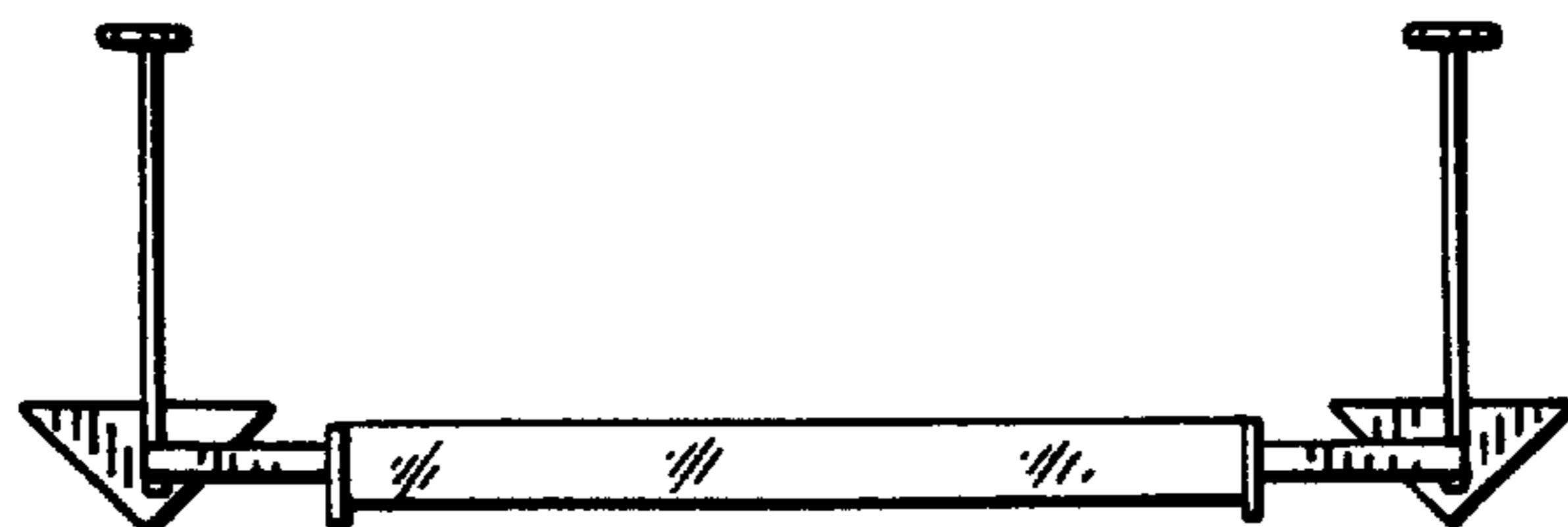

FIG. 34