



US00D443073S

(12) **United States Design Patent**
Wilson

(10) **Patent No.:** **US D443,073 S**

(45) **Date of Patent:** **** May 29, 2001**

(54) **PREMIER S CORNER WITHOUT BRACKETS**

2,993,306 * 7/1961 Persons 52/556
3,289,380 * 12/1966 Charniga, Jr. 52/287.1

(75) Inventor: **Rick Wilson**, Forney, TX (US)

* cited by examiner

(73) Assignee: **Classic Industries, Inc.**, Forney, TX (US)

Primary Examiner—Doris Clark

(74) *Attorney, Agent, or Firm*—Jackson Walker L.L.P.

(**) Term: **14 Years**

(57) **CLAIM**

The ornamental design for a “premier S corner without brackets,” as shown and described.

(21) Appl. No.: **29/121,677**

(22) Filed: **Apr. 12, 2000**

DESCRIPTION

(51) **LOC (7) Cl.** **25-01**

FIG. 1 is the top view of the premier S corner without brackets;

(52) **U.S. Cl.** **D25/102**

FIG. 2 is the bottom view thereof;

(58) **Field of Search** D25/102, 136;
52/556, 287.1, 288.1

FIG. 3 is the right side view thereof;

FIG. 4 is the left side view thereof;

FIG. 5 is the rear right side view thereof;

FIG. 6 is the rear left side view thereof; and,

FIG. 7 is the perspective rear view thereof.

(56) **References Cited**

U.S. PATENT DOCUMENTS

D. 388,884 * 1/1998 Karnoski D25/102
2,620,519 * 12/1952 Engelbach 52/556

1 Claim, 2 Drawing Sheets

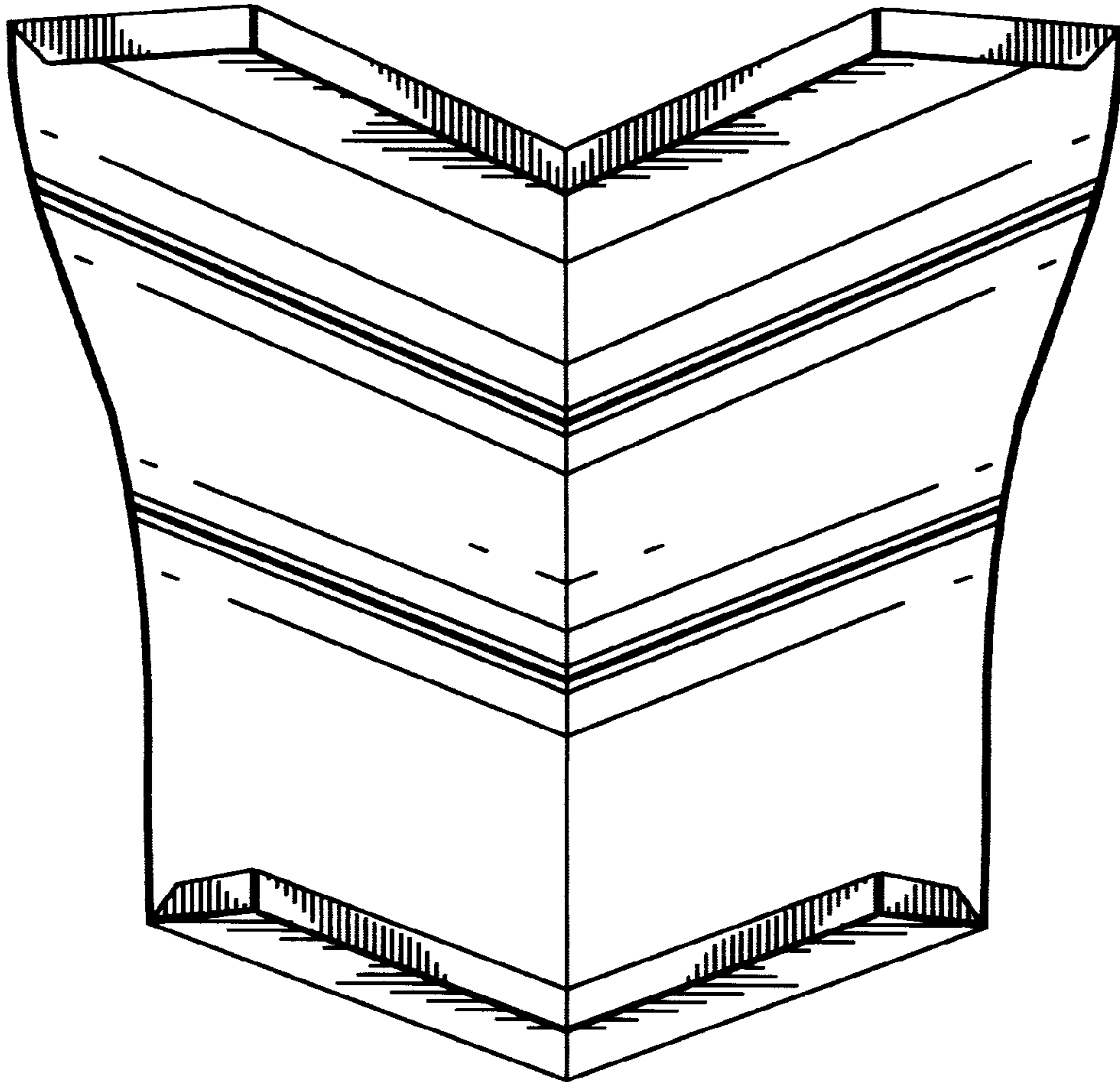

FIG. 1

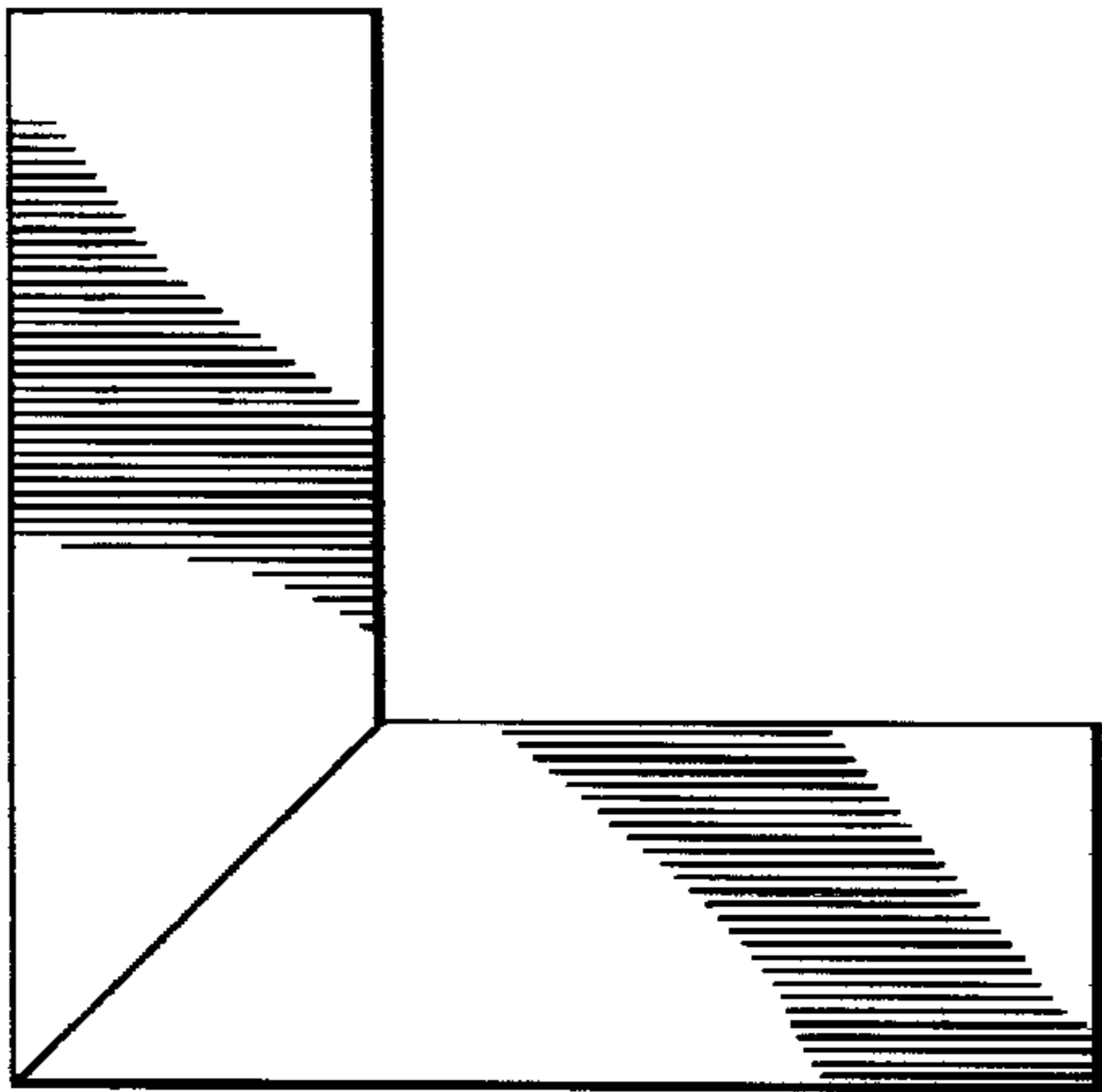

FIG. 2

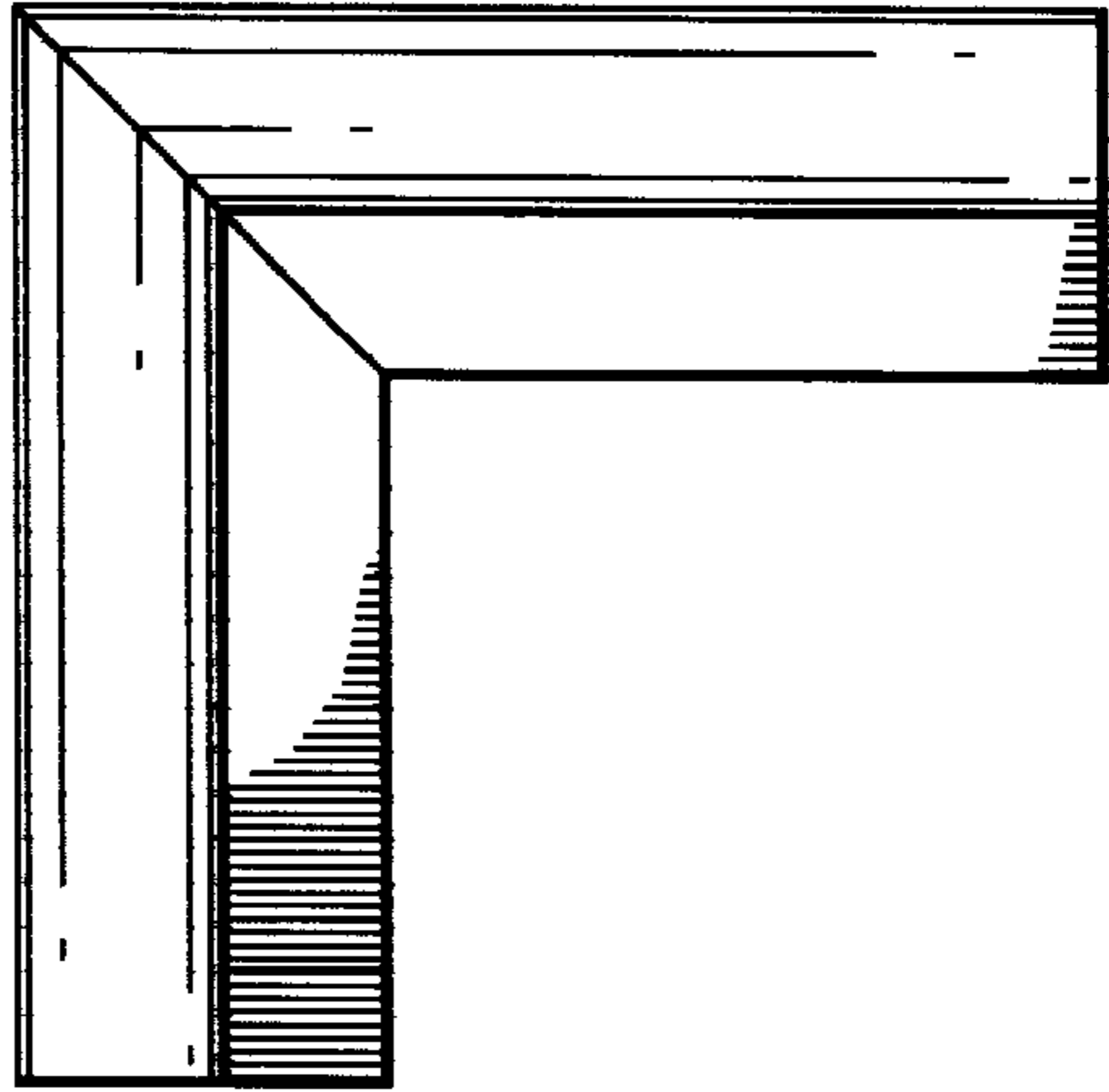

FIG. 3

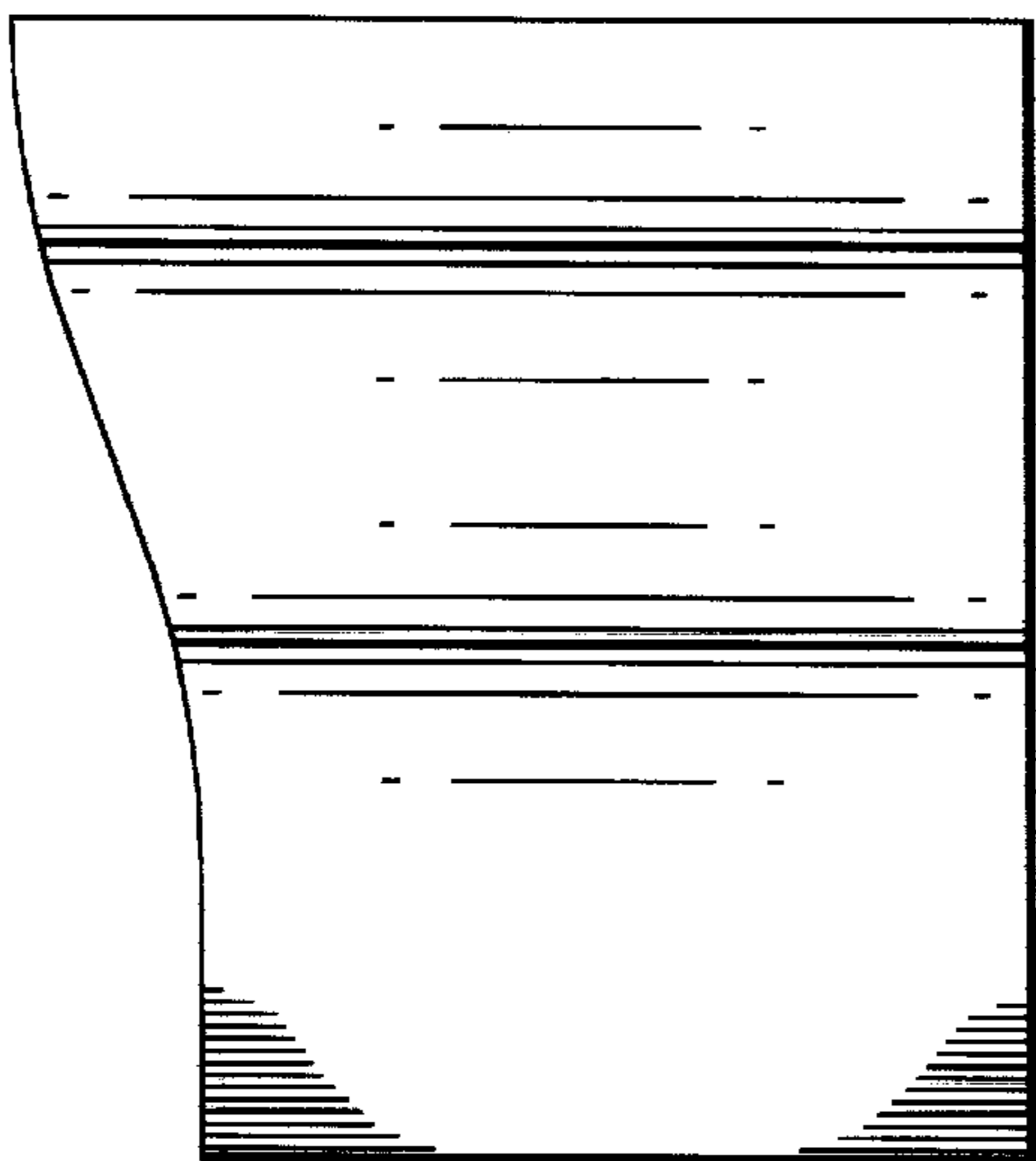

FIG. 4

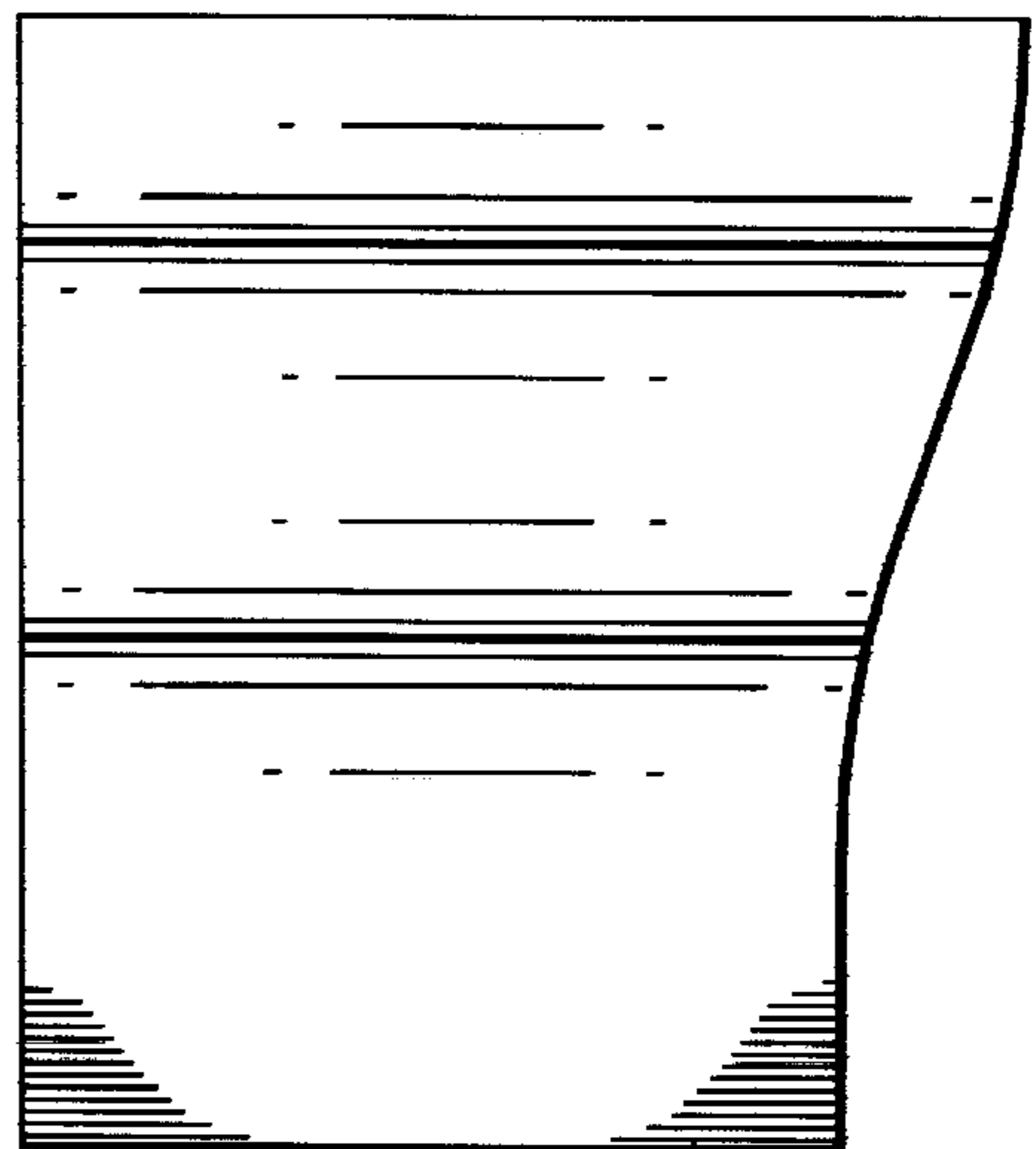

FIG. 5

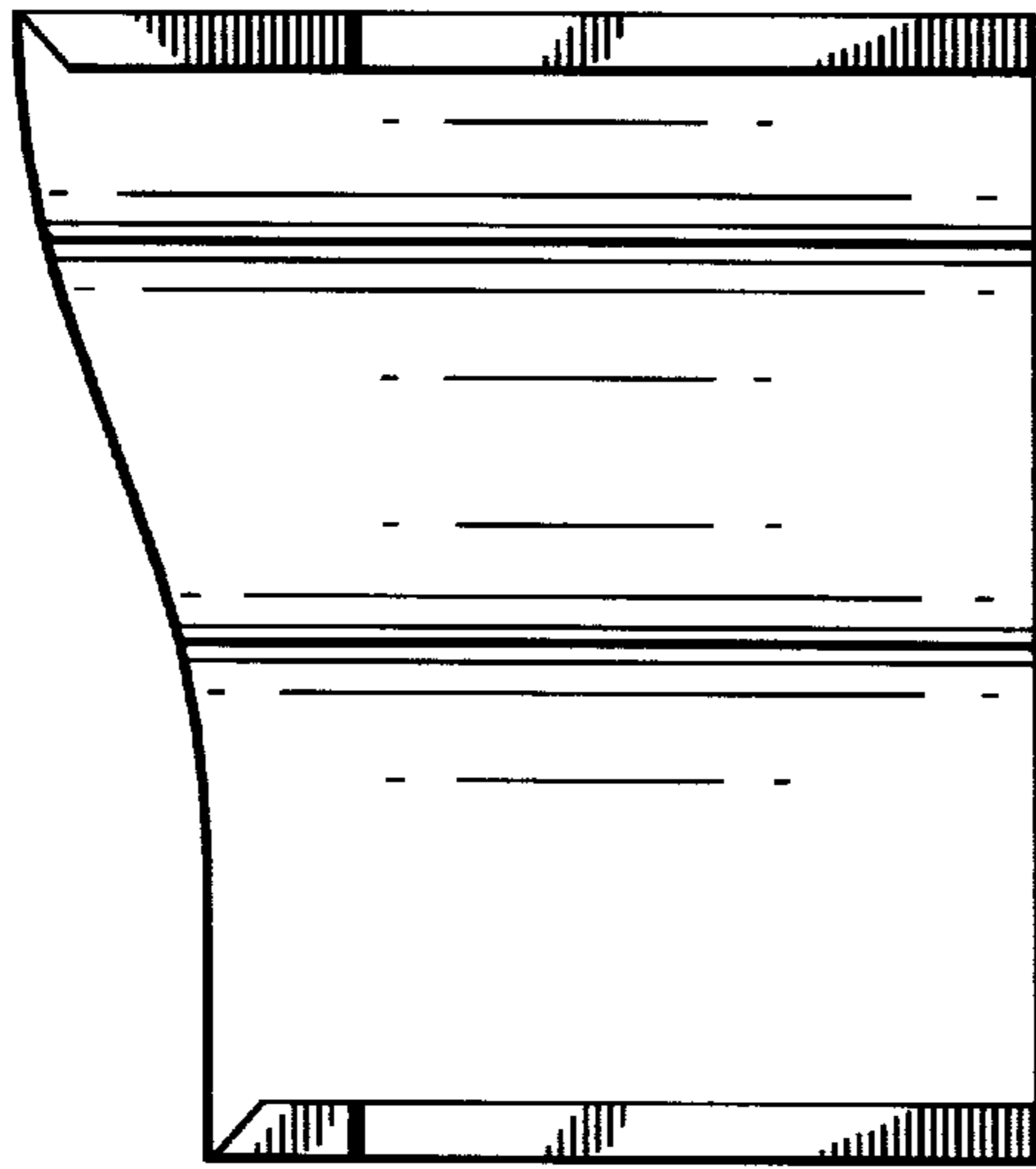

FIG. 6

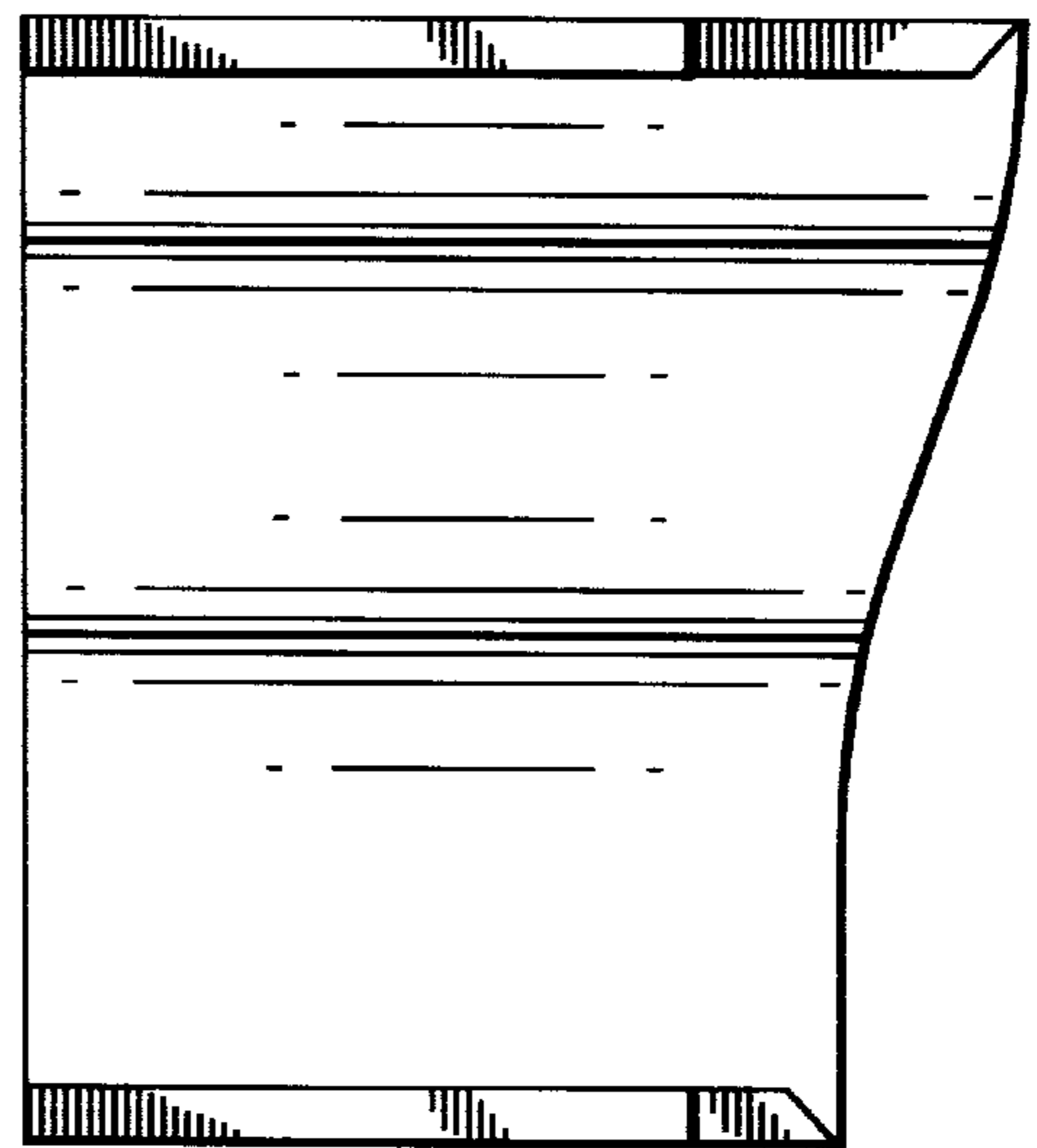

FIG. 7

