



US00D443069S

(12) **United States Design Patent**
Horton

(10) **Patent No.: US D443,069 S**

(45) **Date of Patent: ** May 29, 2001**

- (54) **KIOSK**
- (75) Inventor: **Tony L. Horton**, Dallas, TX (US)
- (73) Assignee: **Viad Corporation**, Grapevine, TX (US)
- (**) Term: **14 Years**
- (21) Appl. No.: **29/122,270**
- (22) Filed: **Apr. 20, 2000**
- (51) **LOC (7) Cl. 25-03**
- (52) **U.S. Cl. D25/16**
- (58) **Field of Search D25/16; 52/36.1,**
52/63, 74, 79.4; D6/470, 476, 421, 423,
432, 555

- D. 367,777 3/1996 Arnone D6/436
- D. 368,606 4/1996 Sargent, III D6/481
- D. 379,664 6/1997 Horton D25/16
- D. 379,665 6/1997 Horton D25/16
- D. 379,666 6/1997 Horton D25/16
- D. 379,667 6/1997 Horton D25/16
- D. 383,854 9/1997 Ruscitto D25/16
- D. 396,113 7/1998 Horton D25/16
- D. 396,114 7/1998 Horton D25/16
- D. 403,179 12/1998 Horton D6/474
- D. 405,629 2/1999 Horton D6/474
- D. 406,354 3/1999 Horton D25/16
- D. 406,903 3/1999 Horton D25/16
- D. 407,921 4/1999 Horton D6/474
- D. 413,392 8/1999 Horton D25/16
- 589,971 9/1897 Kephart .
- 2,836,860 6/1958 Staropoli 20/1.6
- 3,715,815 2/1973 Lewis 35/60
- 4,572,598 2/1986 Moore 312/284
- 5,048,857 9/1991 Stevens 280/651
- 5,375,899 12/1994 Wright 296/21
- 5,551,774 9/1996 Campbell et al. 312/284
- 5,692,342 * 12/1997 Devlin, Jr. 52/36.1

(56) **References Cited**
U.S. PATENT DOCUMENTS

- D. 54,883 4/1920 Willett .
- D. 85,555 11/1931 Stebbings .
- D. 148,842 3/1948 Cushman D30/11
- D. 149,381 4/1948 Schick D80/9
- D. 152,219 12/1948 Schick D80/9
- D. 152,371 1/1949 Schick D80/11
- D. 200,225 2/1965 Benjamin D80/11
- D. 219,579 12/1970 Wormser D25/4
- D. 254,327 2/1980 Tasse D25/26
- D. 256,530 8/1980 Johnson D6/144
- D. 260,708 9/1981 Schindler D6/144
- D. 265,617 8/1982 Sauroge, III et al. D6/144
- D. 279,408 6/1985 Davenport D25/25
- D. 288,040 2/1987 LeBlanc D6/473
- D. 288,609 3/1987 Watkins D25/11
- D. 302,221 7/1989 Suttles et al. D6/481
- D. 313,077 12/1990 Minarro D25/16
- D. 326,024 5/1992 Boyd et al. D6/480
- D. 341,458 11/1993 Carroll D34/20
- D. 346,867 5/1994 Montilla D25/16
- D. 348,367 7/1994 Geisen et al. D6/481
- D. 350,829 9/1994 Horton D25/16
- D. 354,816 1/1995 Horton D25/16

* cited by examiner

Primary Examiner—Doris Clark
(74) *Attorney, Agent, or Firm*—Locke Liddell & Sapp LLP

(57) **CLAIM**

The ornamental design for kiosk, as shown and described.

DESCRIPTION

FIG. 1 is a front elevational view of a kiosk showing my new design, the rear elevational view being identical thereto; FIG. 2 is a left side elevational view thereof; FIG. 3 is a right side elevational view thereof; FIG. 4 is a top plan view thereof; FIG. 5 is a bottom plan view thereof; and, FIG. 6 is a sectional view thereof taken generally along sectional lines 6—6 of FIG. 3.

1 Claim, 6 Drawing Sheets

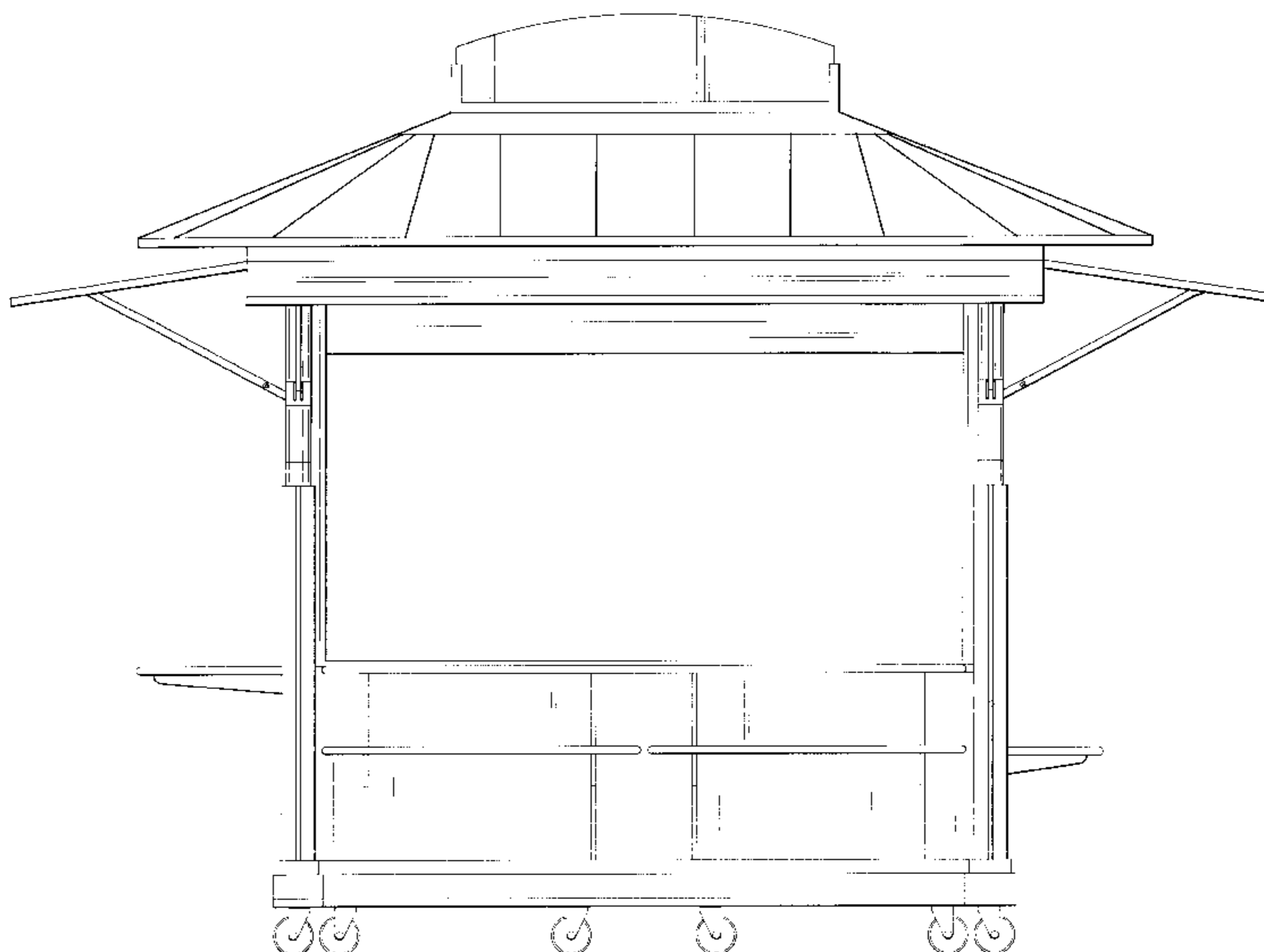

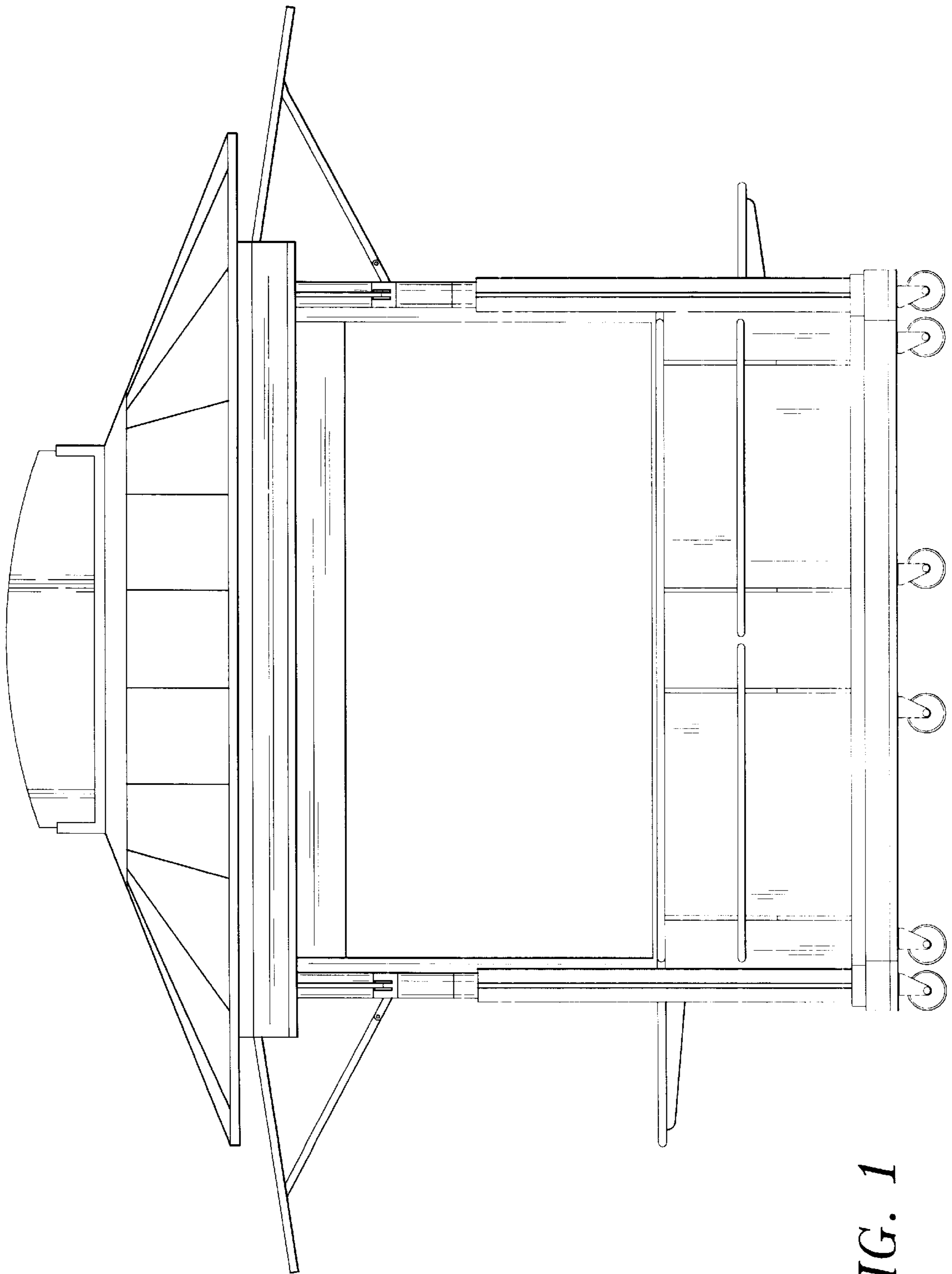

FIG. 1

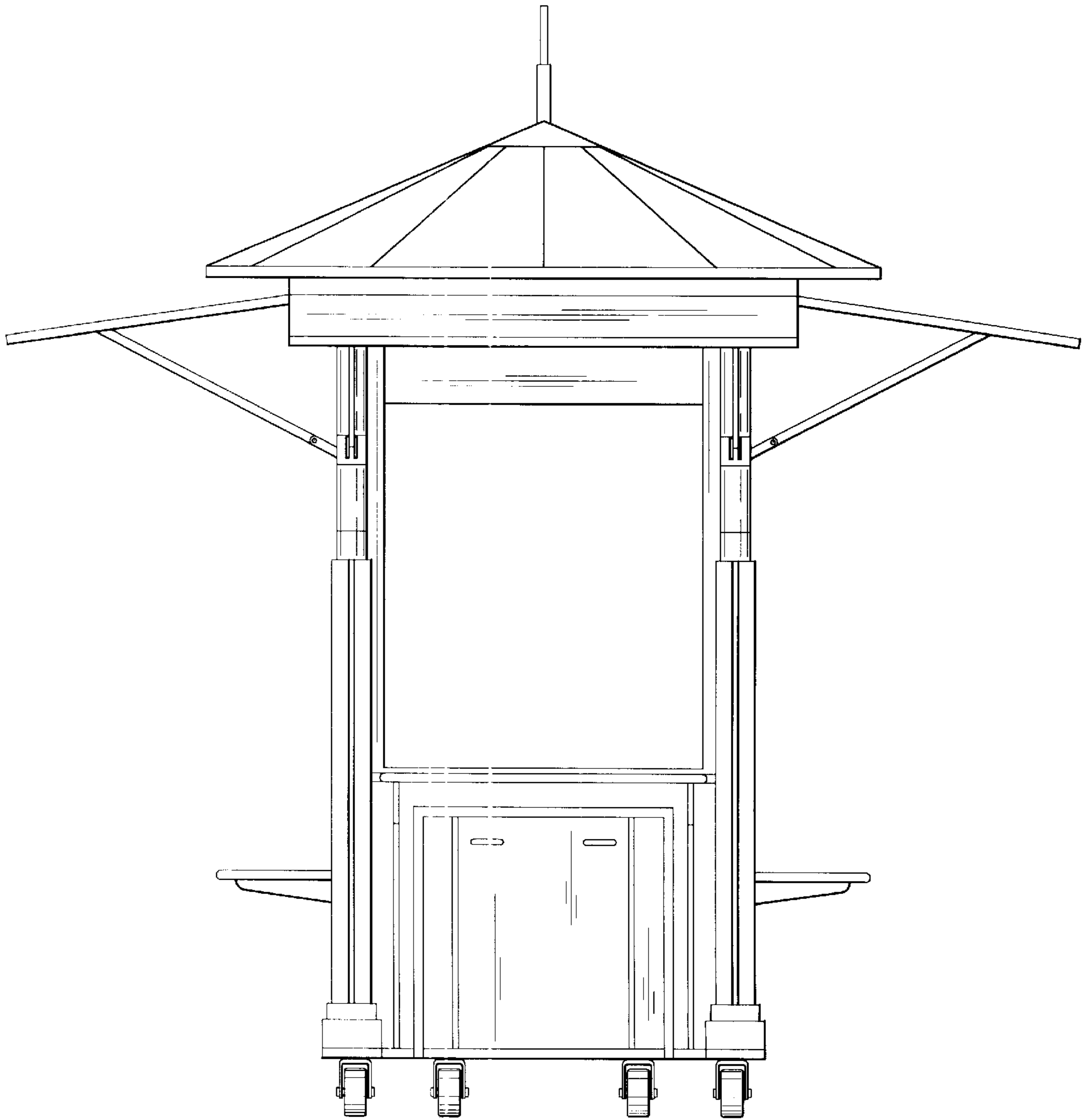

FIG. 2

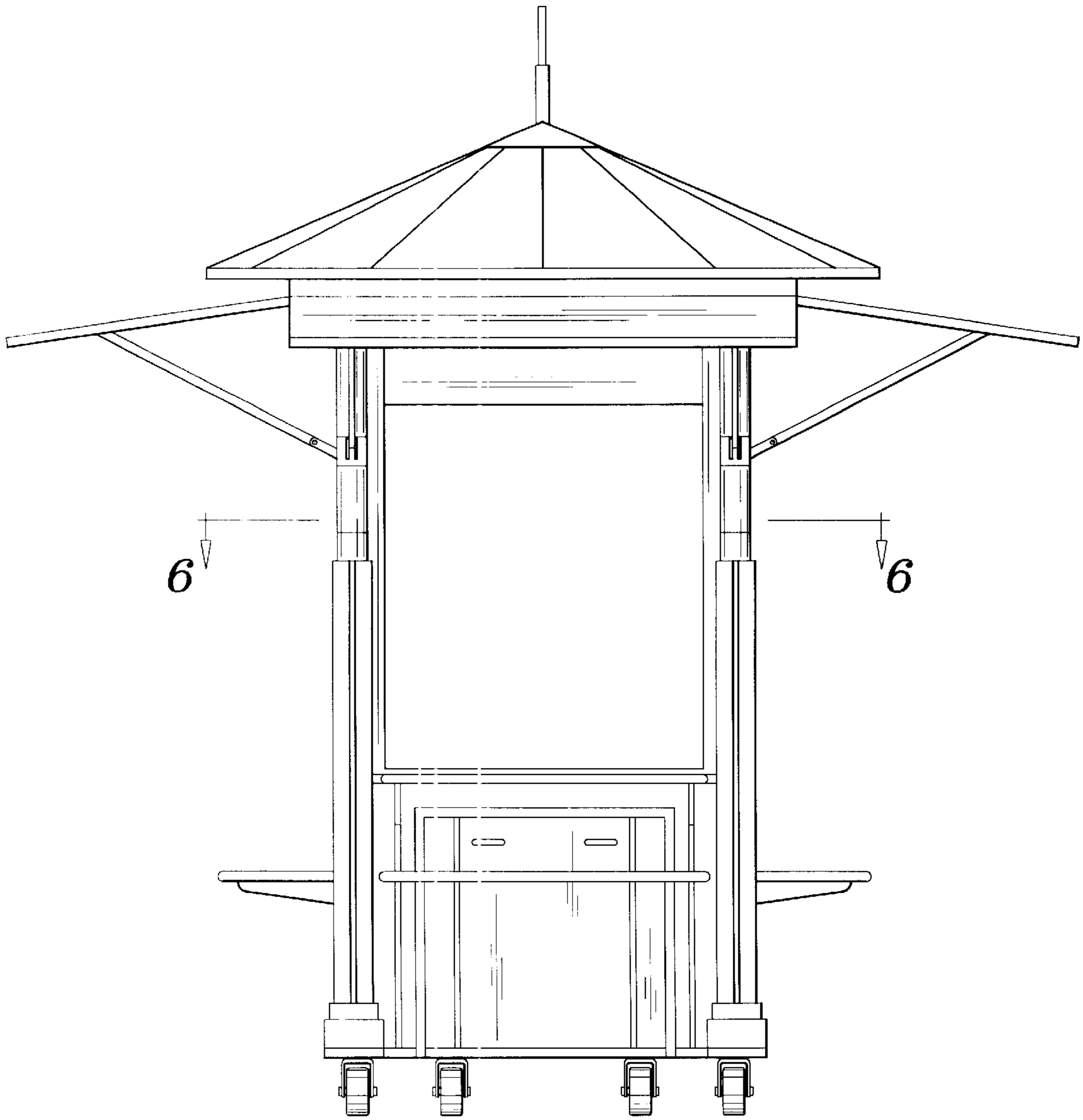

FIG. 3

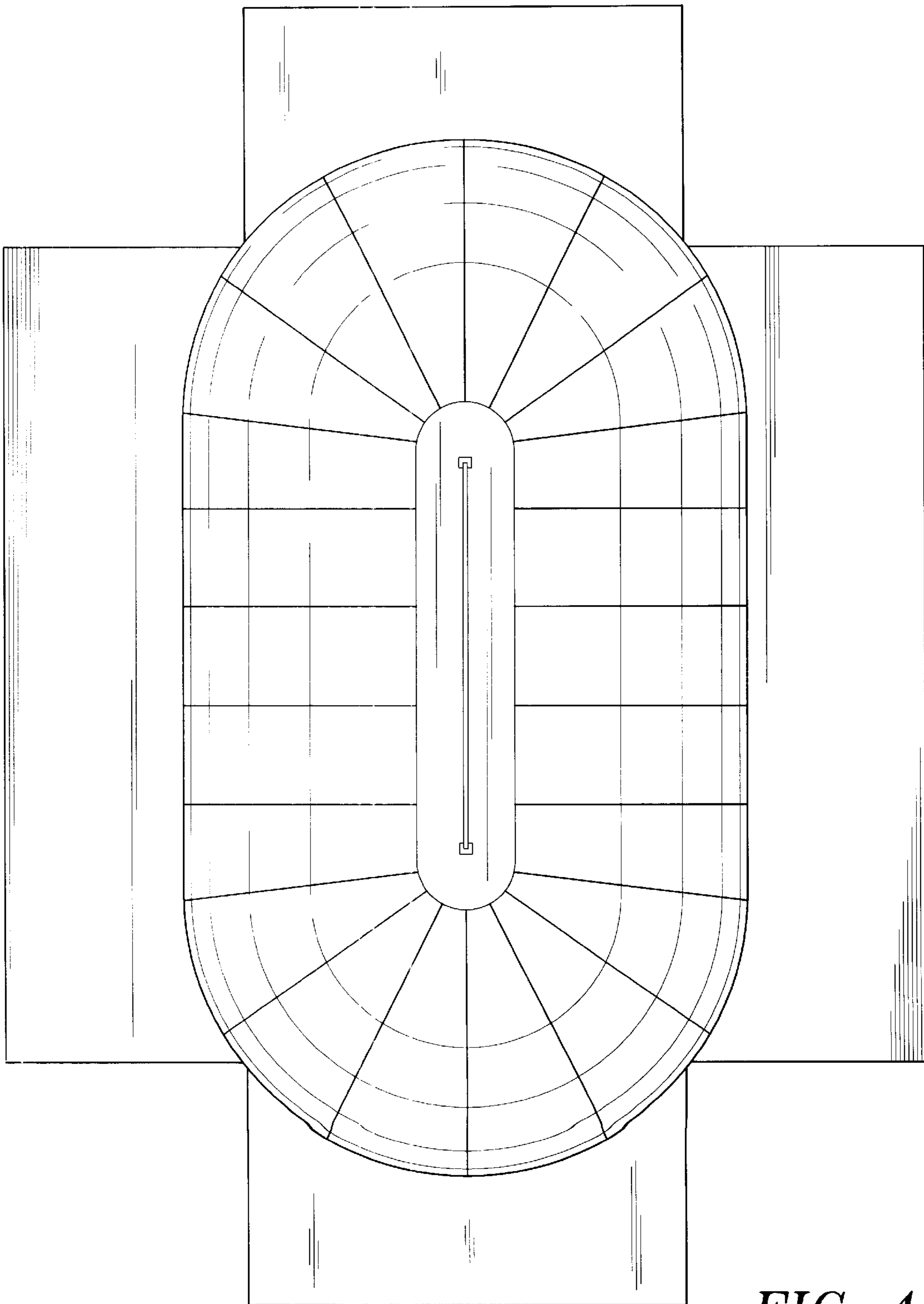

FIG. 4

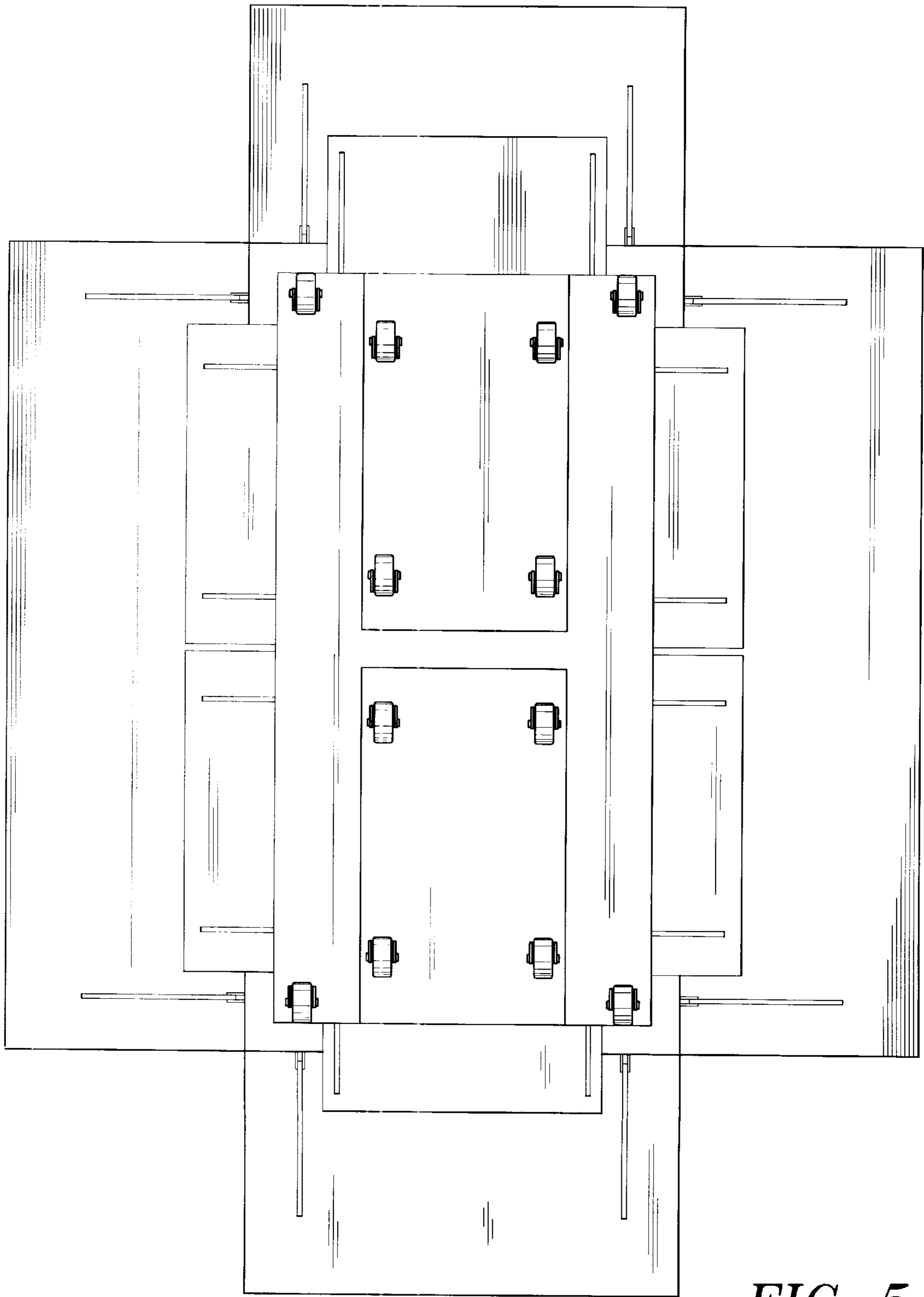

FIG. 5

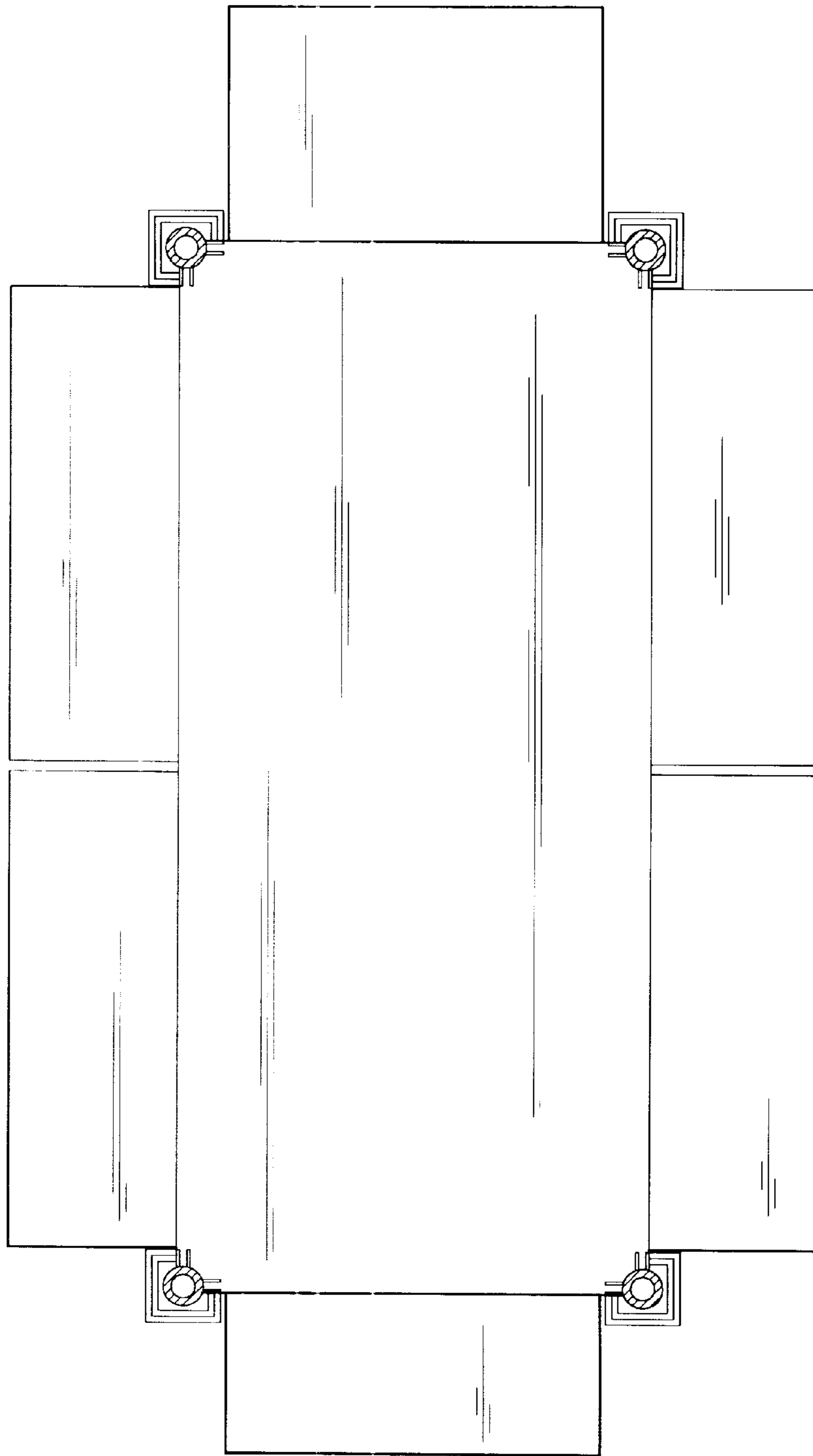

FIG. 6