



US00D443048S

(12) **United States Design Patent**  
**Smith**

(10) **Patent No.:** **US D443,048 S**

(45) **Date of Patent:** **\*\* May 29, 2001**

(54) **LAVATORY**

(75) Inventor: **Michael S. Smith**, Santa Monica, CA  
(US)

(73) Assignee: **Kallista, Inc.**, Kohler, WI (US)

(\*\*) Term: **14 Years**

(21) Appl. No.: **29/116,339**

(22) Filed: **Dec. 30, 1999**

(51) **LOC (7) Cl.** ..... **23-02**

(52) **U.S. Cl.** ..... **D23/284**

(58) **Field of Search** ..... D23/270-274,  
D23/284-291, 292, 293.1, 303, 308; 4/619,  
631-632, 637-643, 660

(56) **References Cited**

**U.S. PATENT DOCUMENTS**

- D. 77,877 \* 3/1929 Brain ..... D23/291
- D. 82,116 \* 9/1930 Steele ..... D23/291
- D. 88,713 \* 12/1932 Kohler et al. .... D23/292 X
- D. 115,623 \* 7/1939 Kohlmeyer ..... D23/284

**OTHER PUBLICATIONS**

- “Marietta” item #I-3325F, Borg-Warner catalog, Oct. 7, 1964, p. 2.\*
- 1999 Bath and More website ad showing a pedestal lavatory.
- 1997 Kohler catalog ad, p. 14.8, showing a “Portrait” pedestal lavatory.
- 1999 Kallista catalog ad, p. 47, showing a “Hampstead” pedestal lavatory.

Undated Eljer catalog ad, p. 2.12, showing a “Carthaginian” lavatory.

\* cited by examiner

*Primary Examiner*—Louis S. Zarfes

*Assistant Examiner*—Robert A. Delehanty

(74) *Attorney, Agent, or Firm*—Quarles & Brady LLP

(57) **CLAIM**

The ornamental design for a lavatory, as shown and described.

**DESCRIPTION**

In a preferred embodiment, the nature of this product is as a plumbing fixture mountable on a pedestal and primarily useful for washing the face and hands of humans.

FIG. 1 is a left, top, front perspective view of a lavatory embodying my new design;

FIG. 2 is a top plan view thereof;

FIG. 3 is a front elevational view thereof;

FIG. 4 is a right side elevational view thereof, the left side elevational view being identical to the right side shown;

FIG. 5 is a rear elevational view thereof;

FIG. 6 is a bottom plan view thereof; and,

FIG. 7 is a cross-sectional view thereof taken along line 7—7 of FIG. 2.

The broken line representations of holes in FIGS. 1 and 2 are for the purpose of illustration only, and form no part of the claimed design.

**1 Claim, 3 Drawing Sheets**

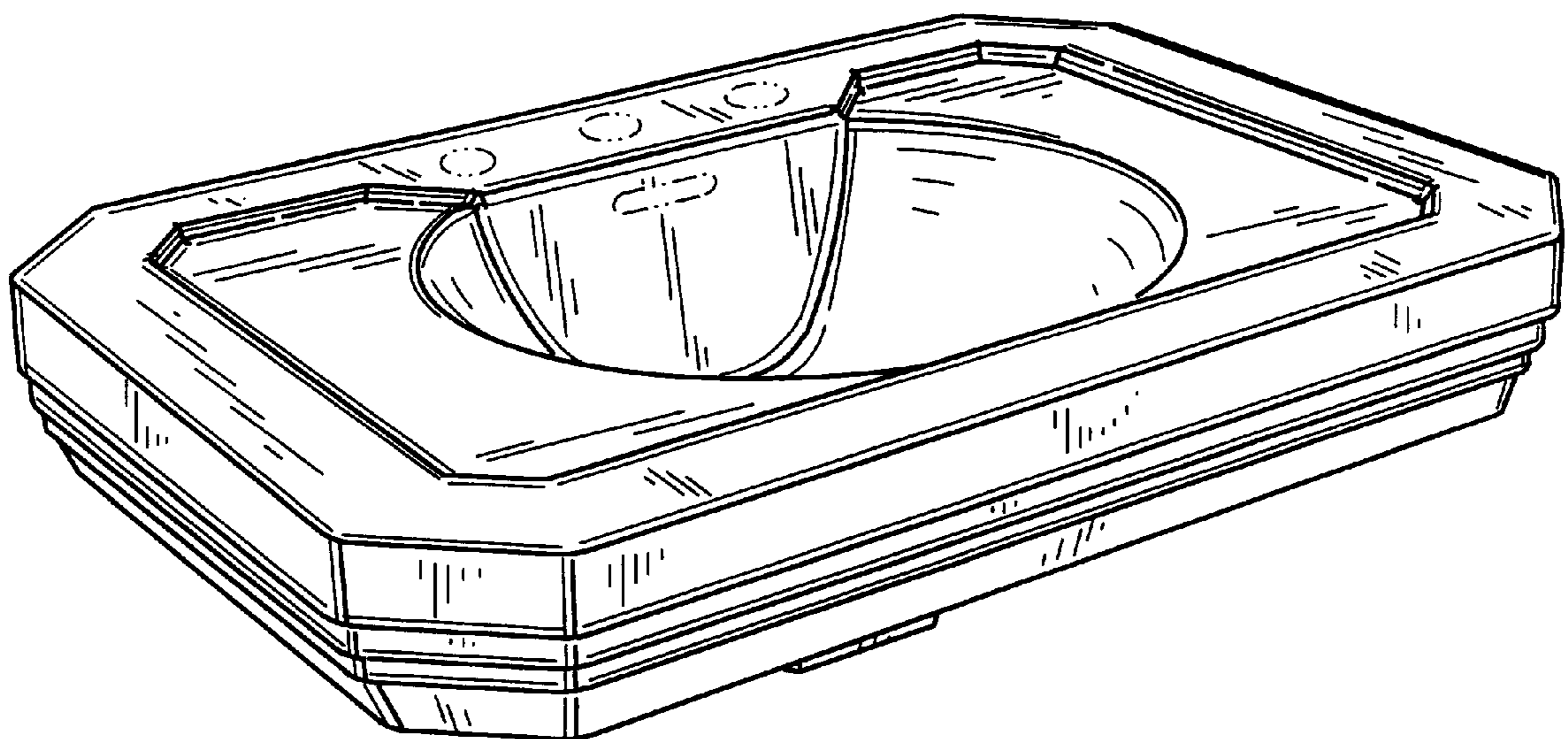

FIG. 1

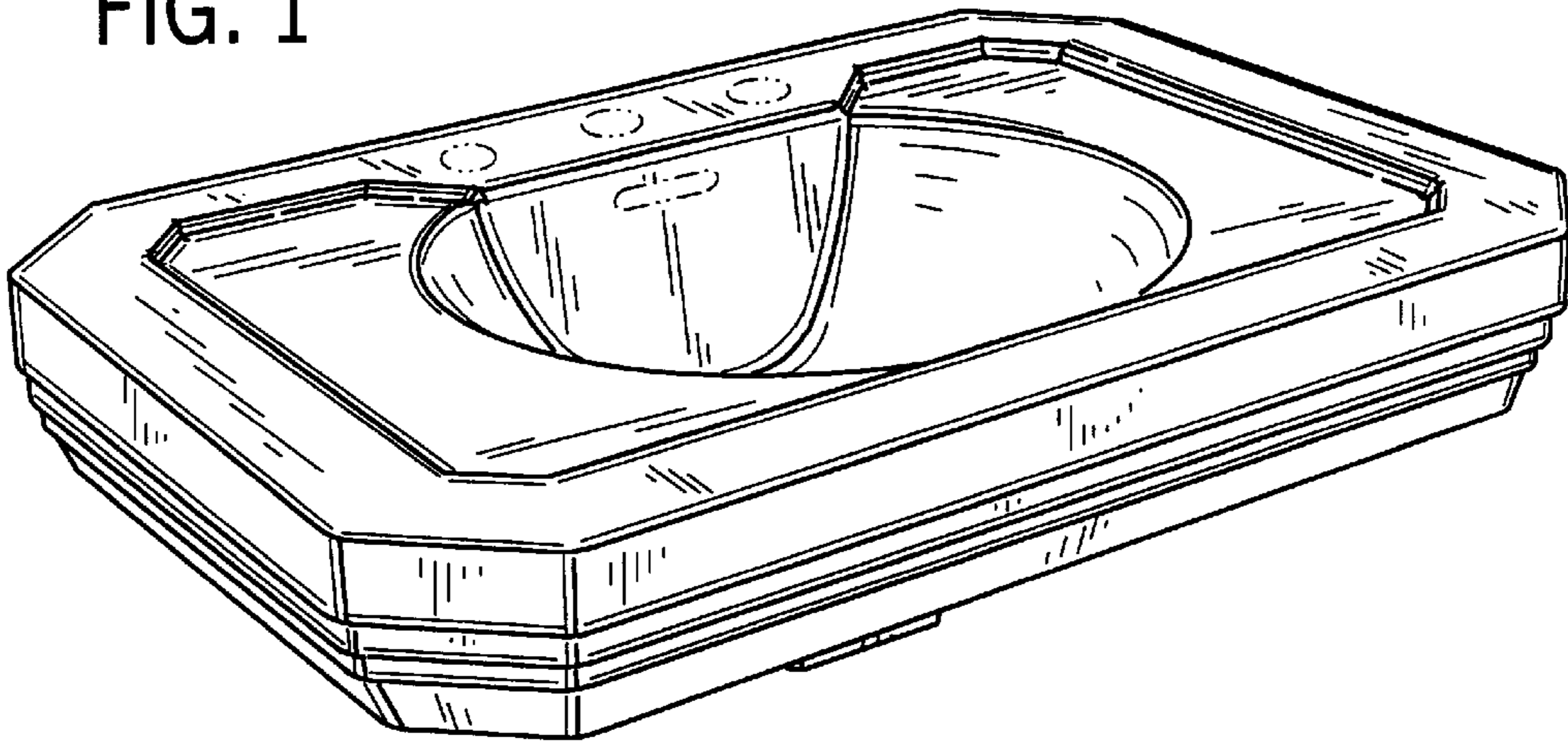

FIG. 2

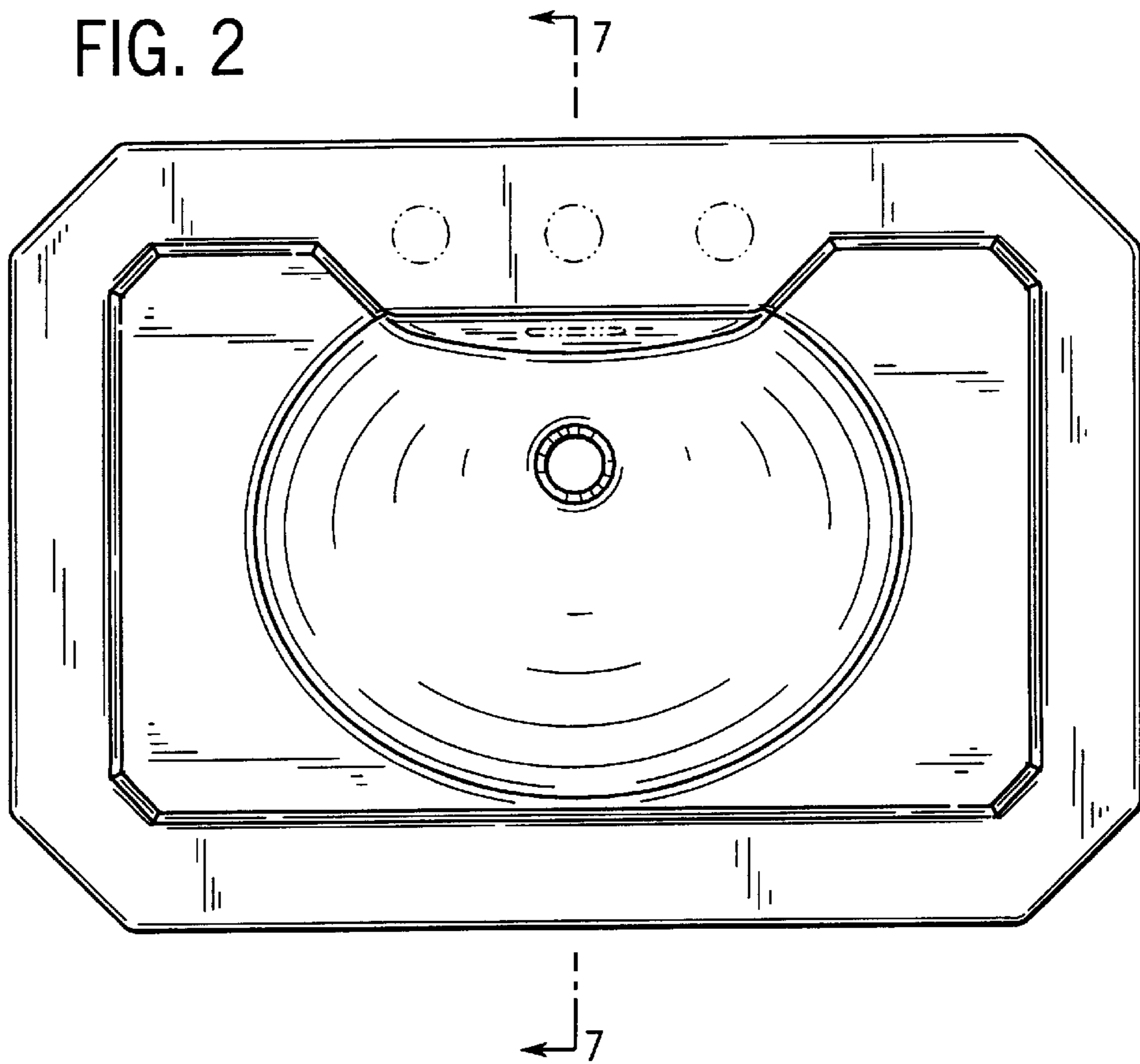

FIG. 3

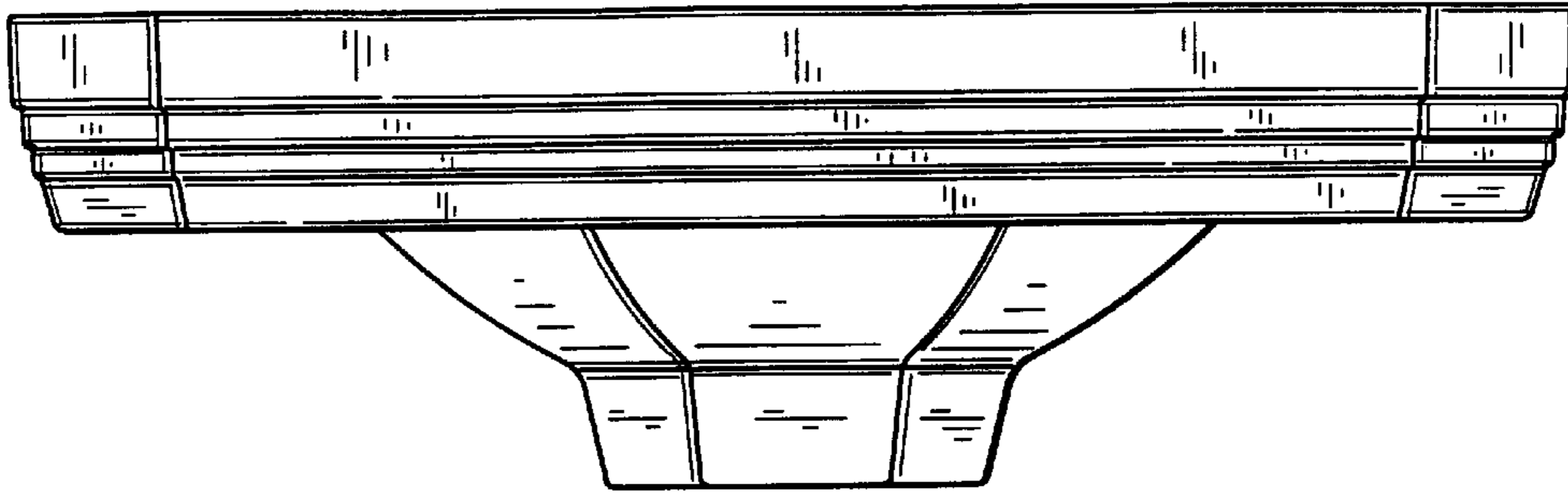

FIG. 4

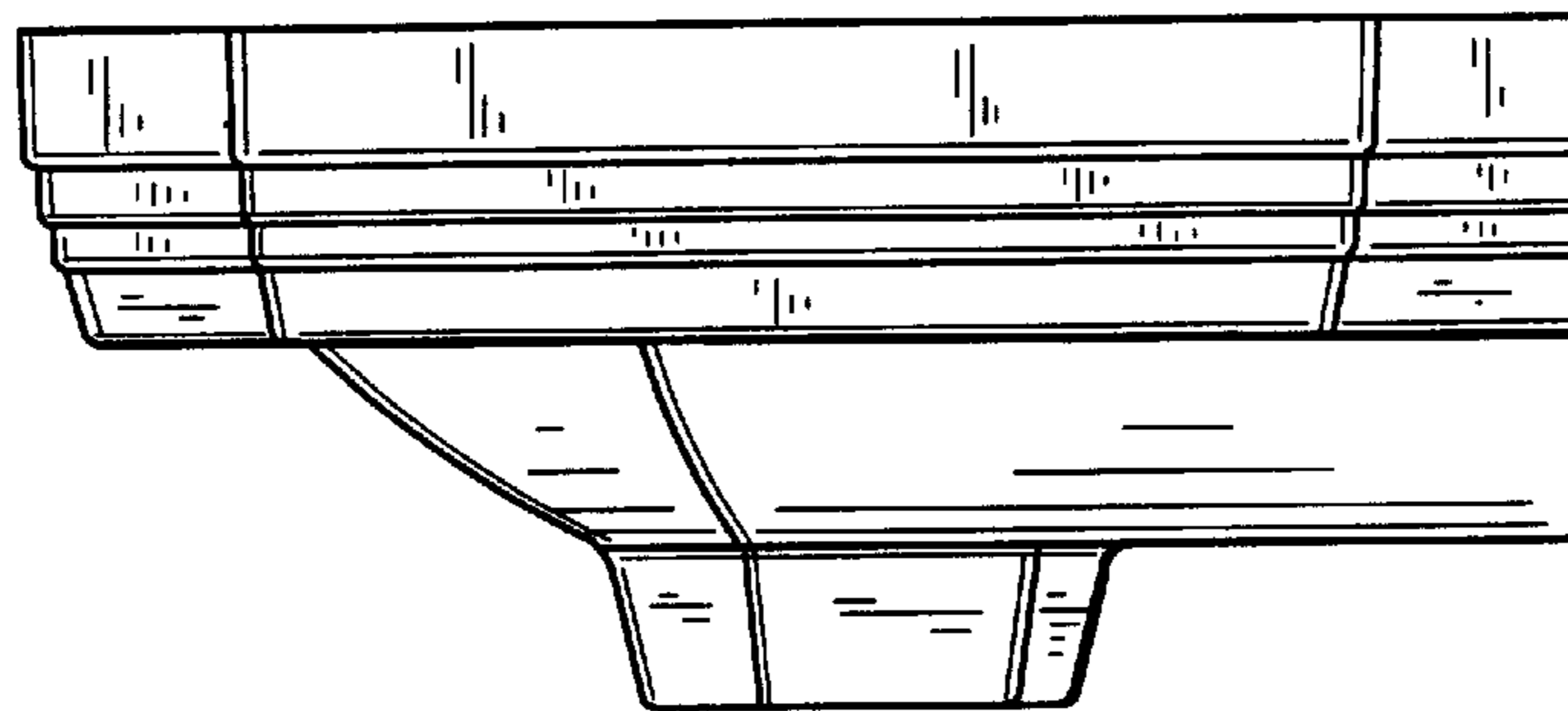

FIG. 5

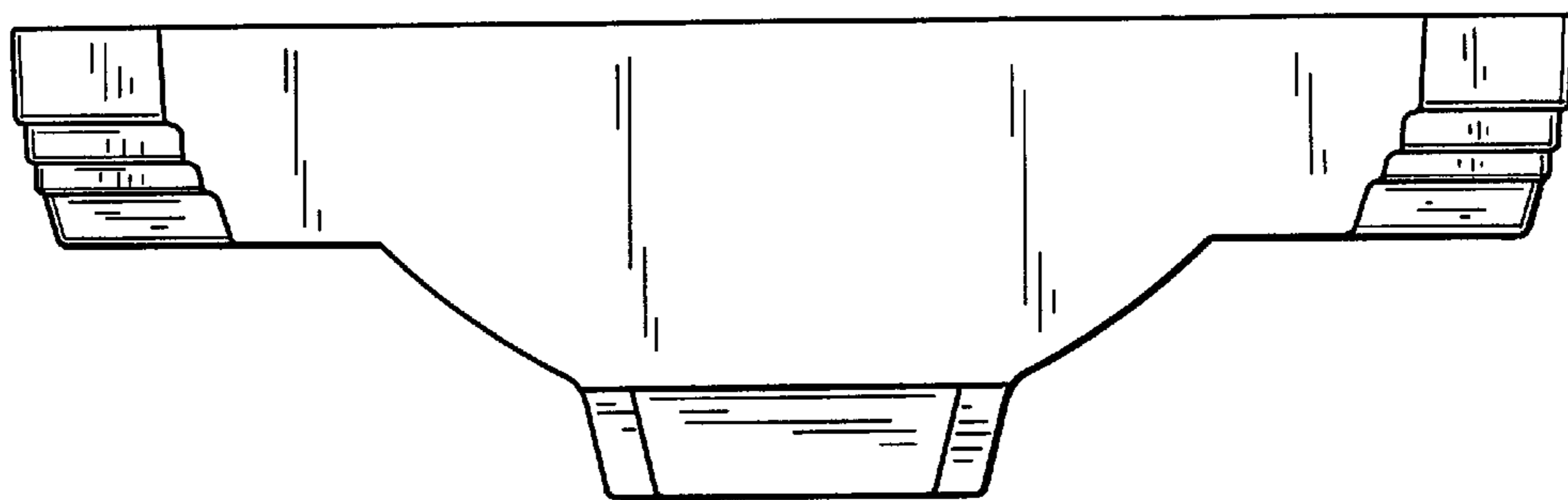

FIG. 6

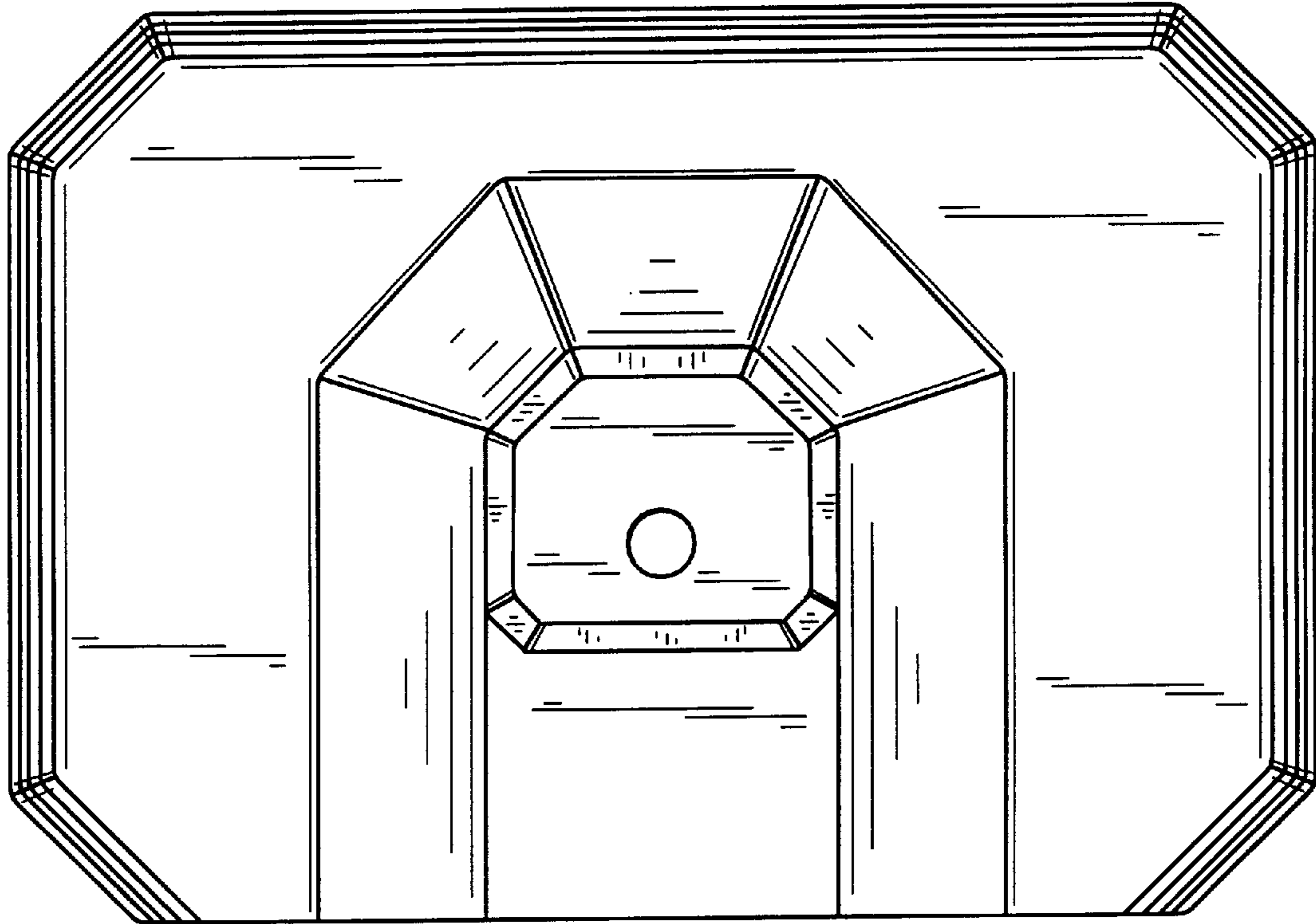

FIG. 7

