



US00D443004S

(12) **United States Design Patent**
Chan

(10) **Patent No.:** **US D443,004 S**

(45) **Date of Patent:** **** May 29, 2001**

(54) **2-PIECE UPRIGHT TOY VACUUM CLEANER**

(76) Inventor: **Shun Po Chan**, Flat C, 8/F, Tower 9,
Vista Paradiso, Ma on Shan, New
Territories (HK)

(**) Term: **14 Years**

(21) Appl. No.: **29/123,002**

(22) Filed: **May 8, 2000**

(51) **LOC (7) Cl.** **21-01**

(52) **U.S. Cl.** **D21/526; D32/22**

(58) **Field of Search** D32/21-22, 25,
D32/31-34; 15/320-322, 347, 350, 351-352,
353, 331, 334-335, 337, 379, 400, 415.1-422.1;
D21/526; 446/479, 144, 178

(56) **References Cited**

U.S. PATENT DOCUMENTS

D. 278,560	*	4/1985	Wareham	D32/22
D. 280,000	*	8/1985	Klawitter	D21/526
D. 295,770	*	5/1988	Hilton	D21/526
D. 354,593	*	1/1995	Koike	D32/22
D. 361,803	*	8/1995	Houry et al.	D21/526
D. 370,321	*	5/1996	Robinette et al.	D32/22
D. 419,730	*	1/2000	Diebel et al.	D32/22
D. 421,072	*	2/2000	Middledy	D21/526
D. 421,164	*	2/2000	Luebbering	D32/22
D. 429,776	*	8/2000	Gammack et al.	D21/526
D. 429,854	*	8/2000	Hohulin et al.	D32/22

* cited by examiner

Primary Examiner—Ruth McInroy

(74) *Attorney, Agent, or Firm*—Woodbridge & Associates,
P.C.; Richard C. Woodbridge

(57) **CLAIM**

The ornamental design for a 2-piece upright toy vacuum cleaner, as shown and described.

DESCRIPTION

FIG. 1 is a front perspective view of a 2-piece upright toy vacuum cleaner showing my new design;
 FIG. 2 is a front elevational view thereof;
 FIG. 3 is a right side elevational view thereof;
 FIG. 4 is a rear elevational view thereof;
 FIG. 5 is a top plan view thereof;
 FIG. 6 is a bottom plan view thereof;
 FIG. 7 is a front perspective view of a debris canister separated from the toy vacuum cleaner illustrated in FIGS. 1-6;
 FIG. 8 is a top plan view of FIG. 7;
 FIG. 9 is a left side elevational view of FIG. 7;
 FIG. 10 is a front perspective view of FIG. 7;
 FIG. 11 is a rear view of FIG. 7;
 FIG. 12 is a perspective view of an extension nozzle separated from the toy vacuum cleaner shown in FIGS. 1-6;
 FIG. 13 is a side elevational view thereof;
 FIG. 14 is a top plan view thereof; and,
 FIG. 15 is a front elevational view thereof.
 FIGS. 7-11 (hand-held vacuum cleaner) and FIGS. 12-15 (extension nozzle) are shown separate for clarity of illustration.

1 Claim, 5 Drawing Sheets

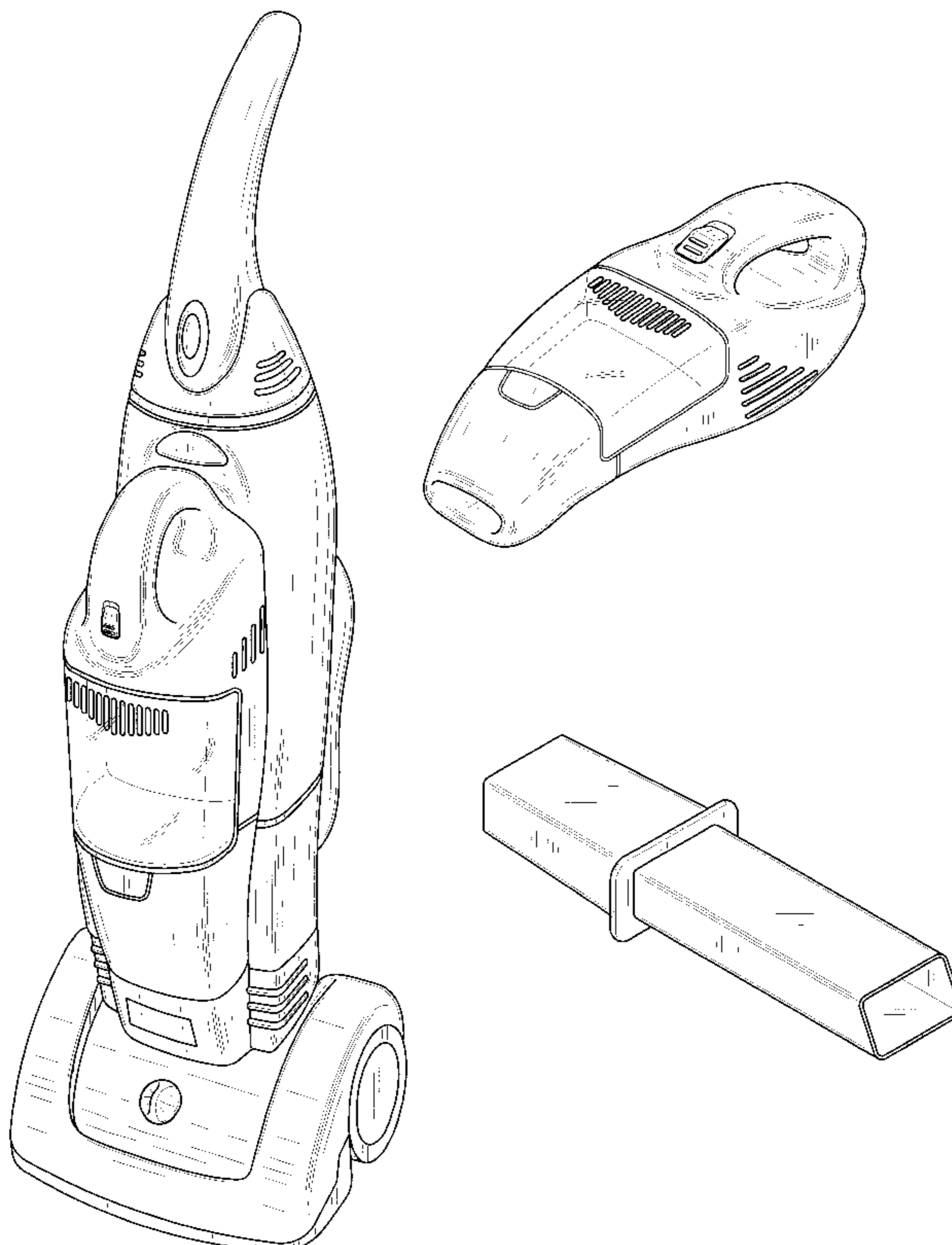

FIG. 1

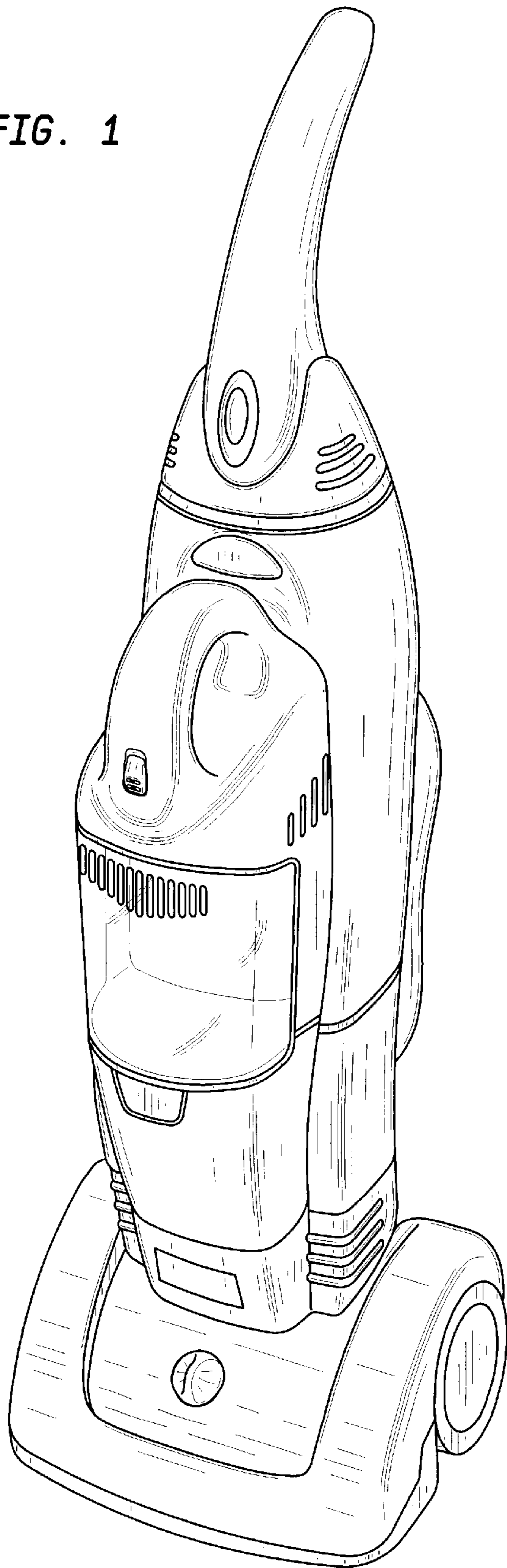

FIG. 2

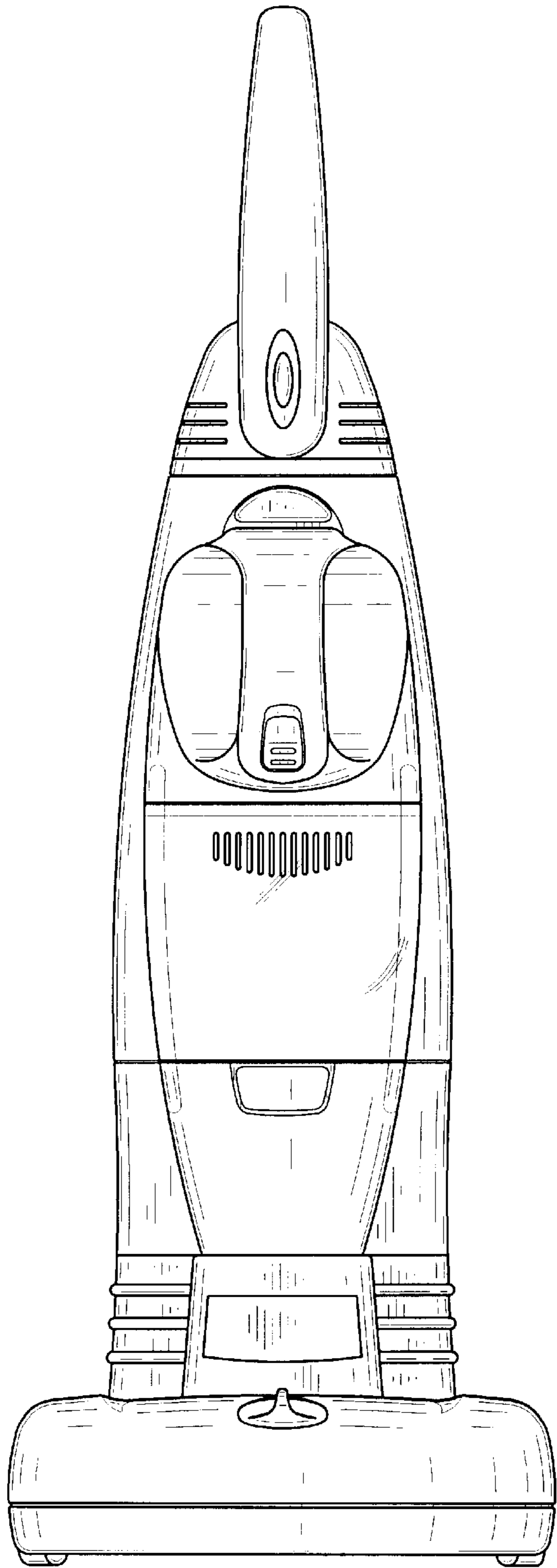

FIG. 3

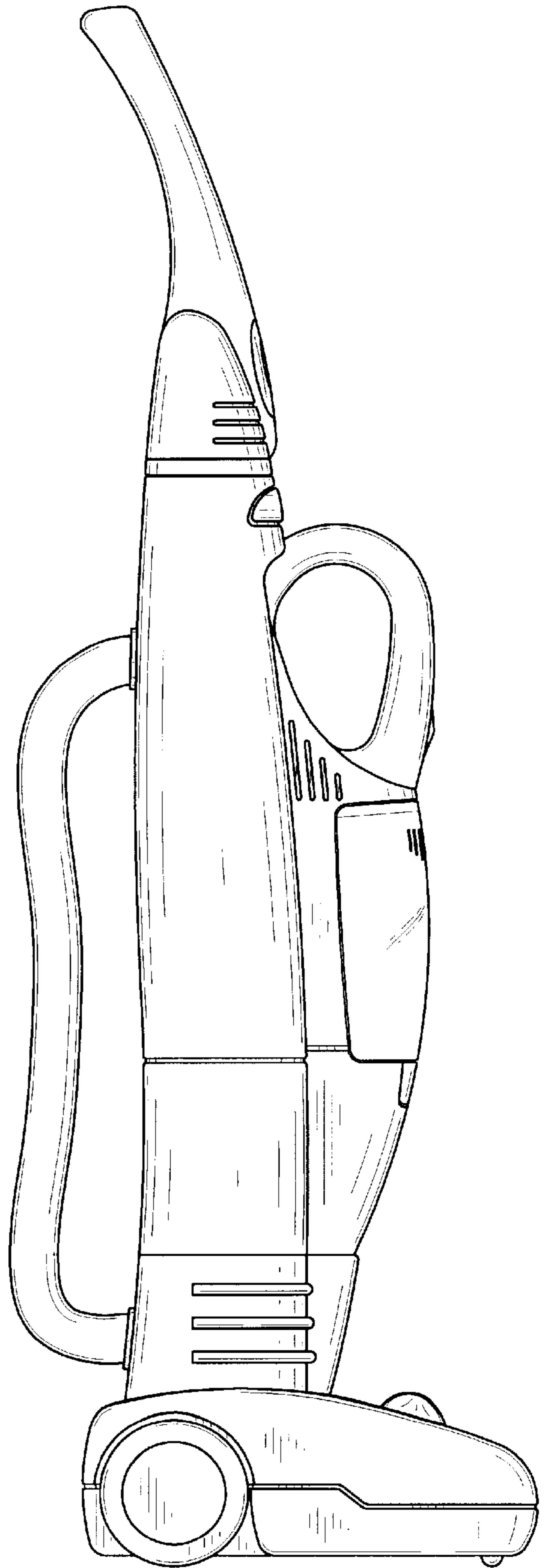

FIG. 4

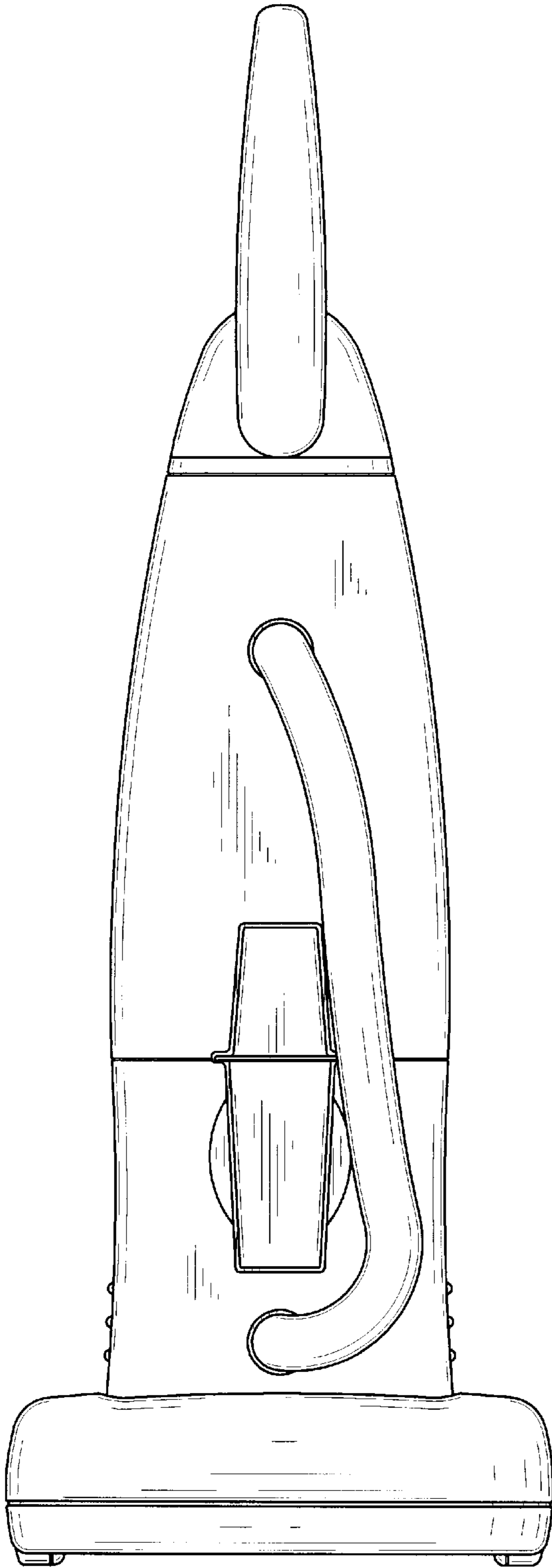

FIG. 5

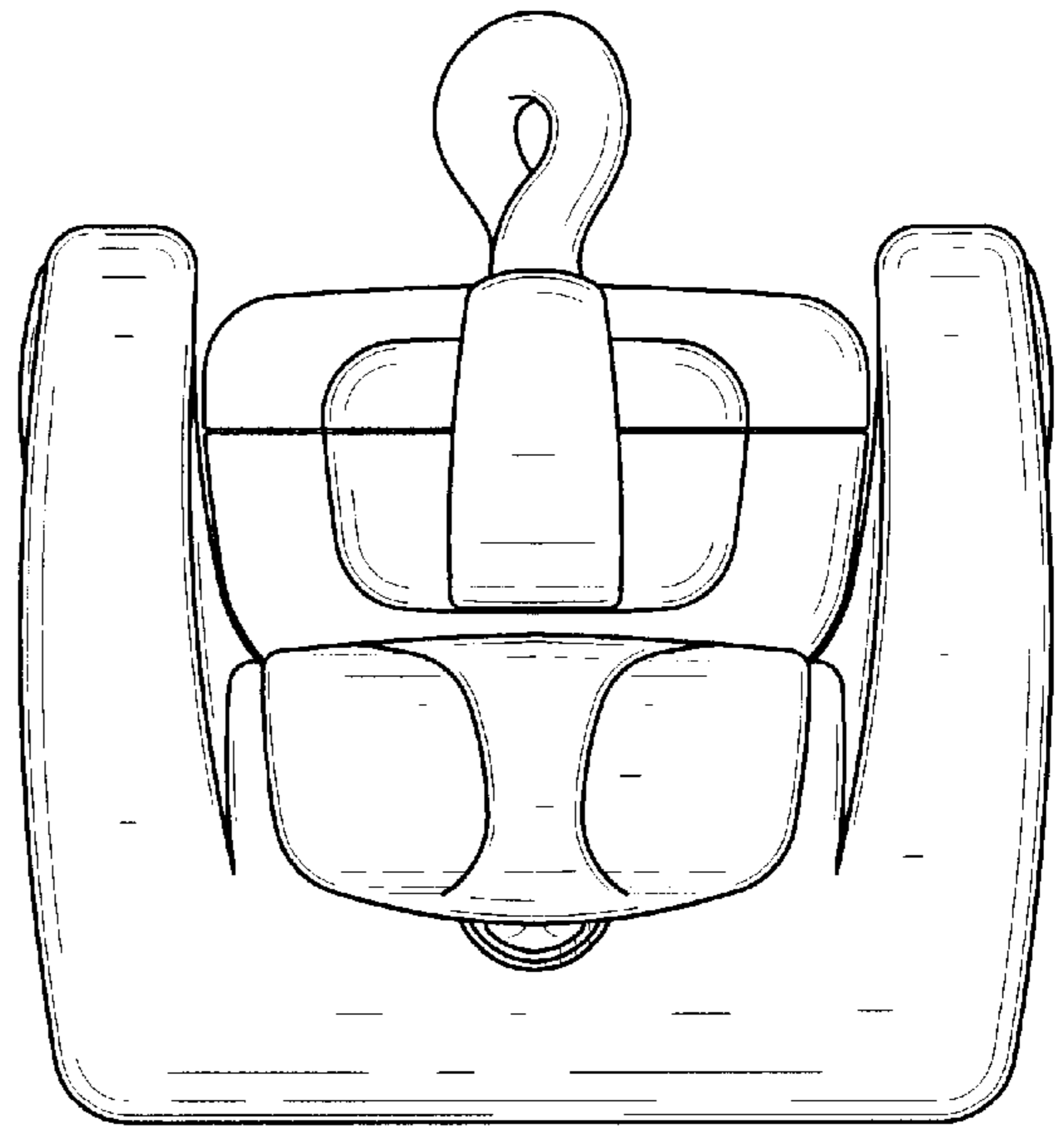

FIG. 6

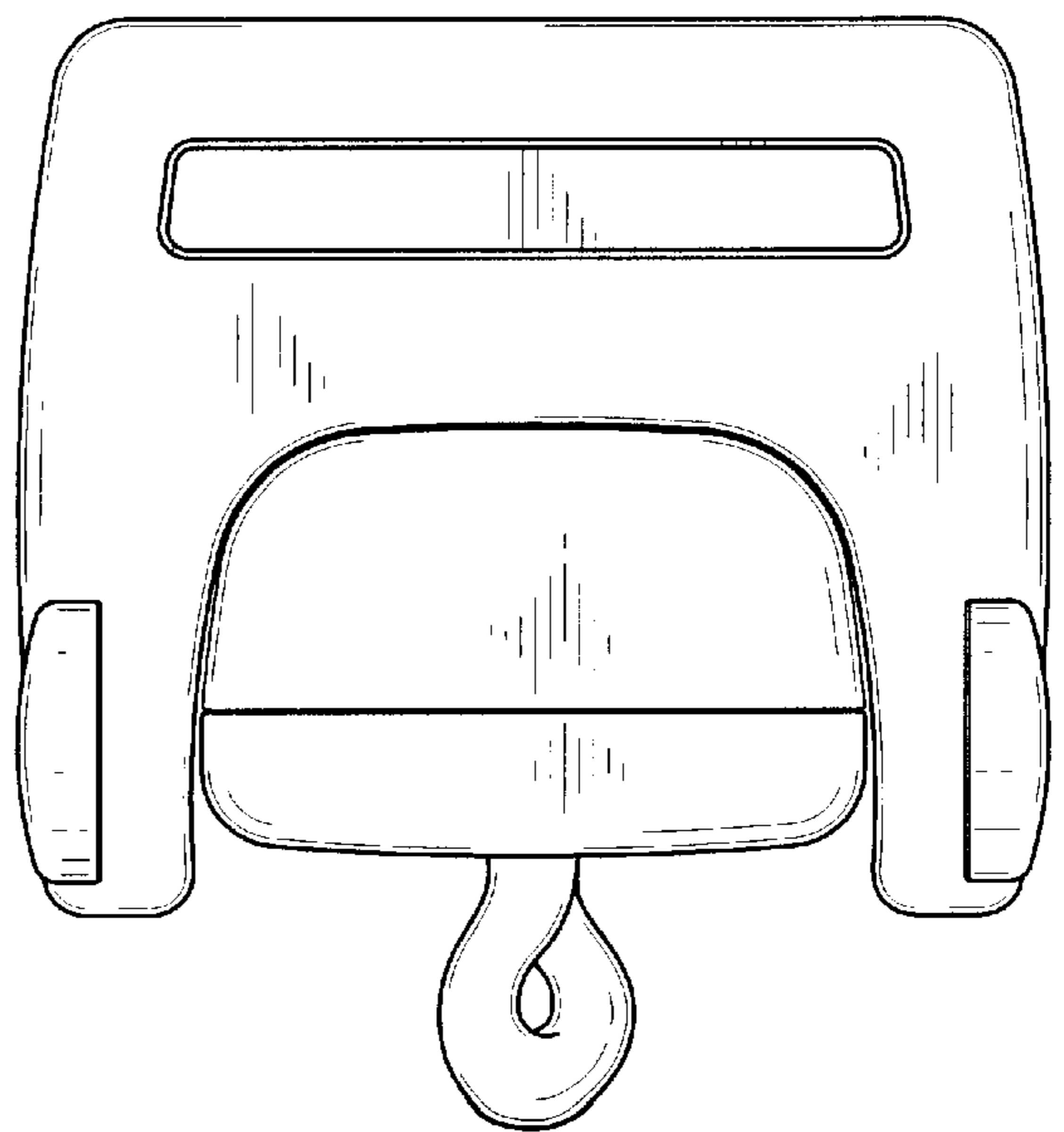

FIG. 7

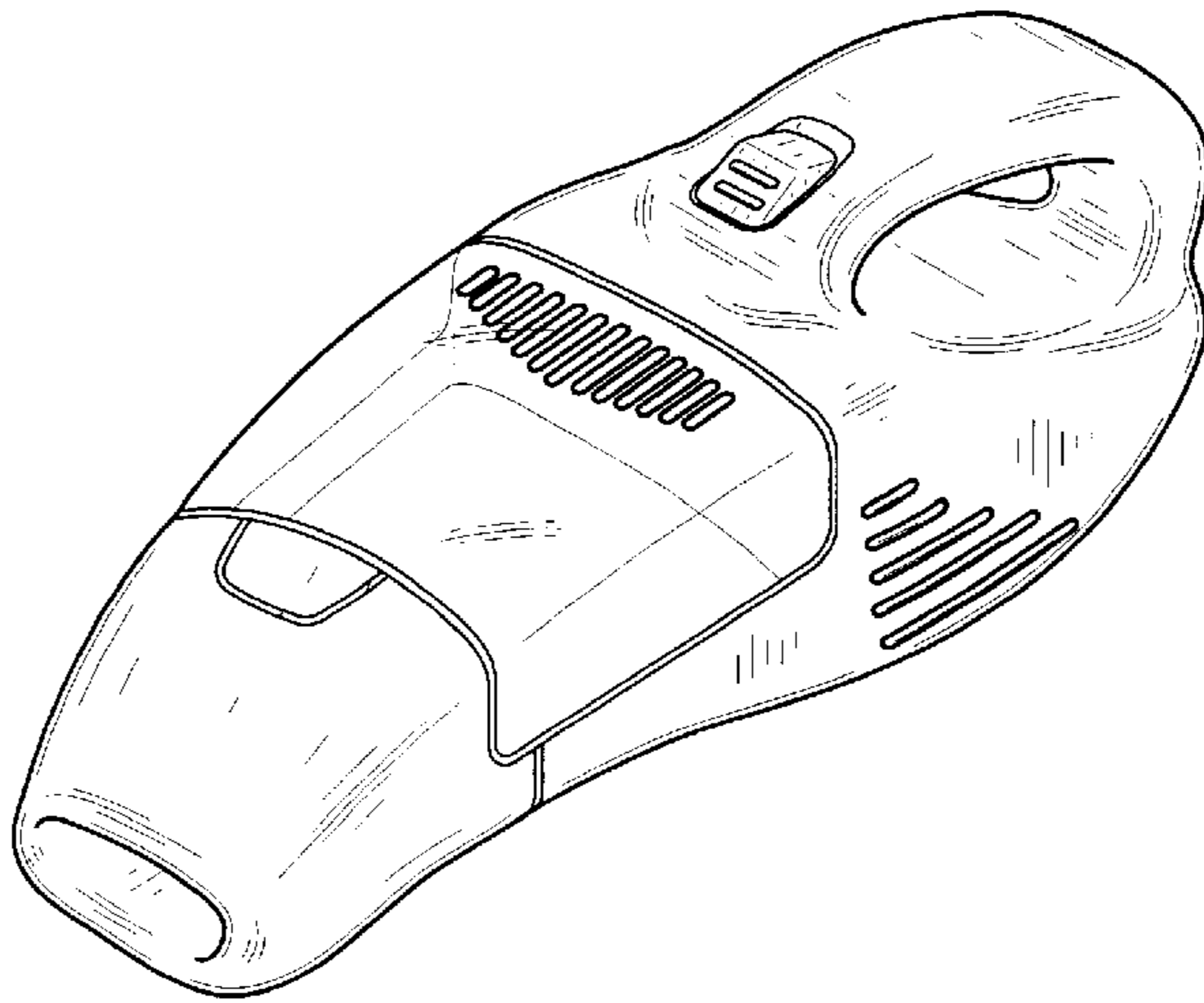

FIG. 8

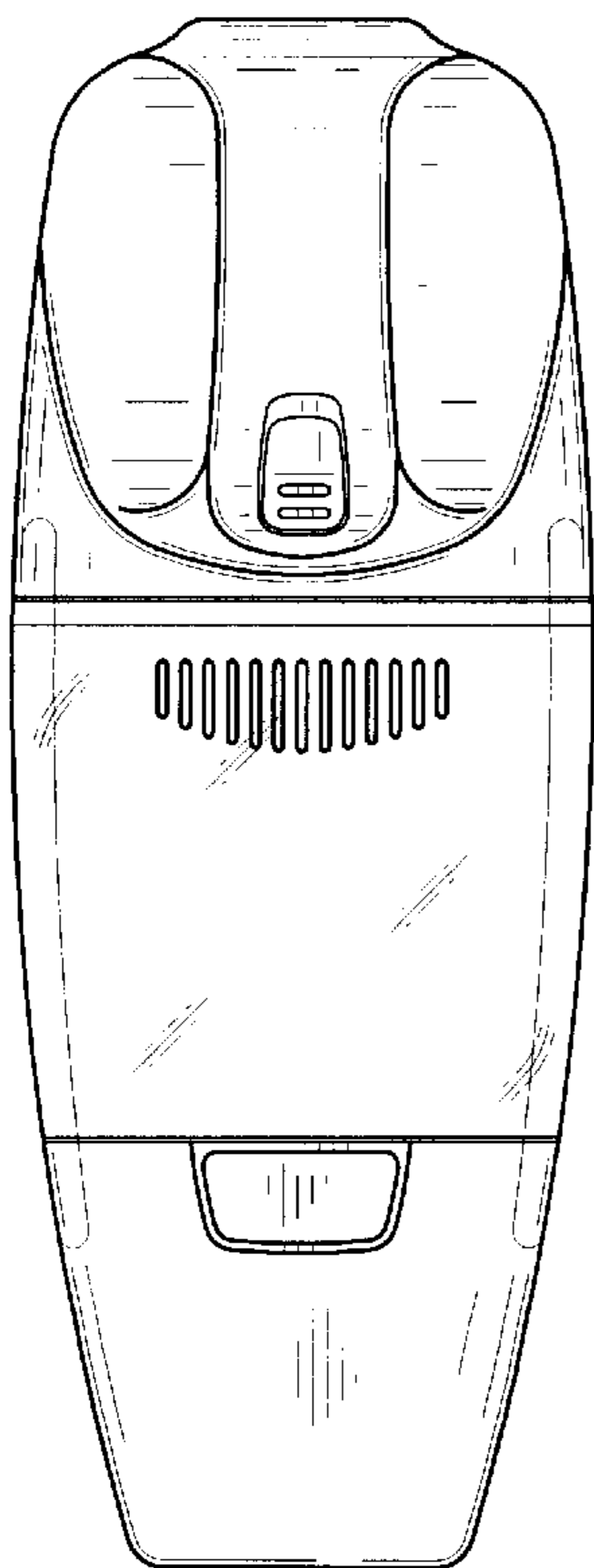

FIG. 9

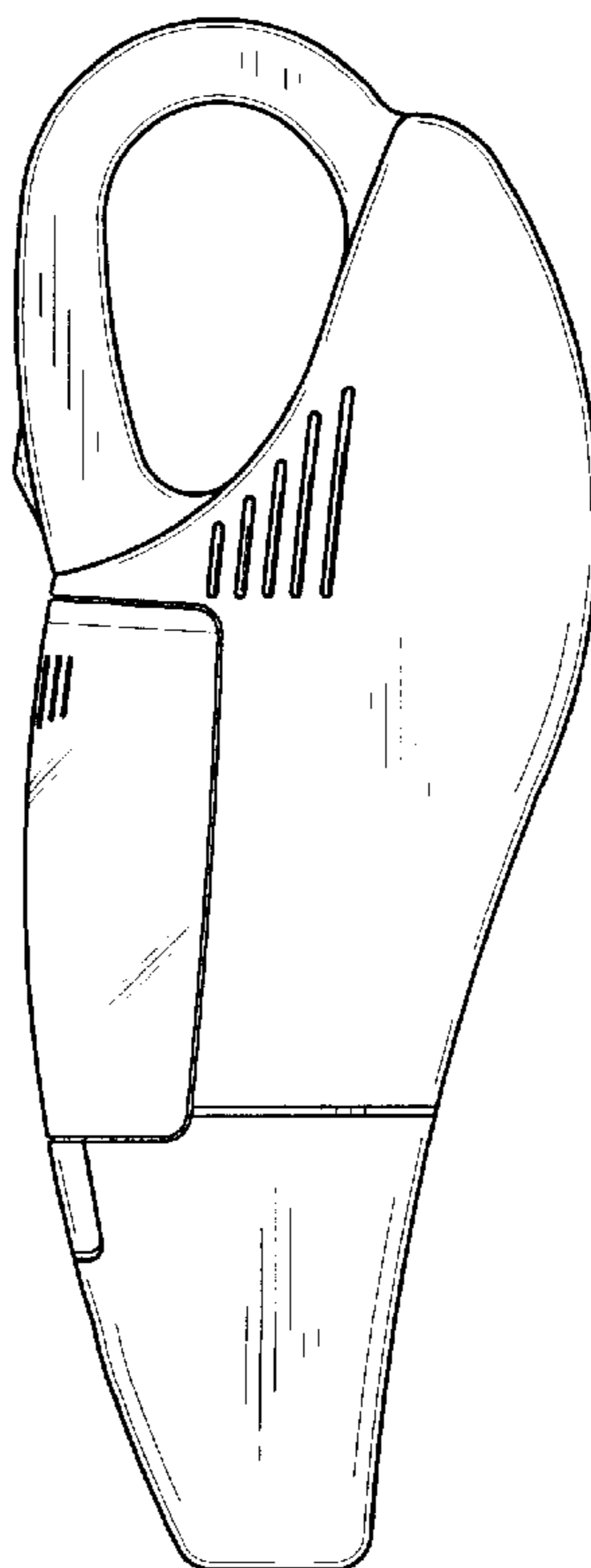

FIG. 10

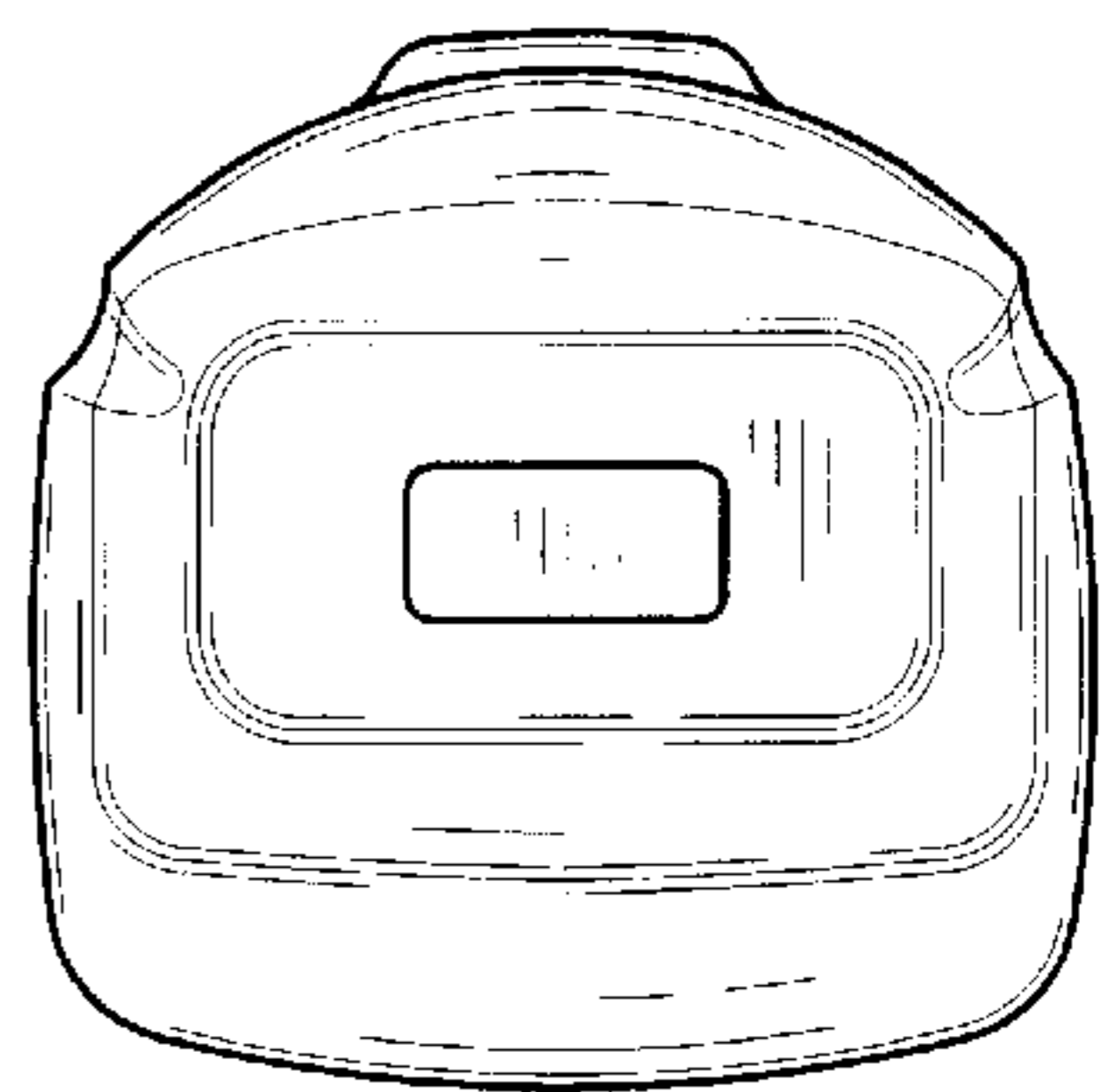

FIG. 11

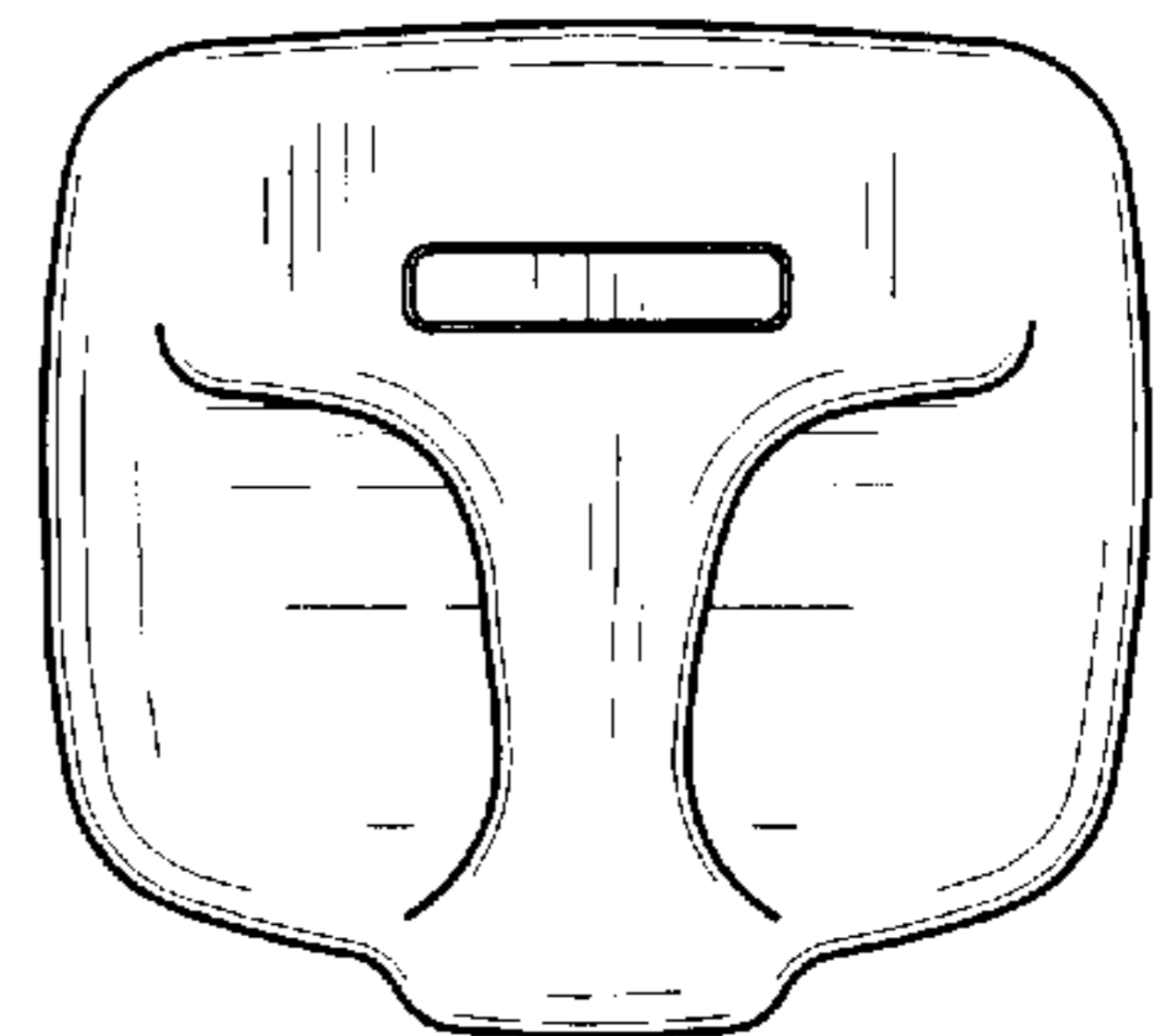

FIG. 12

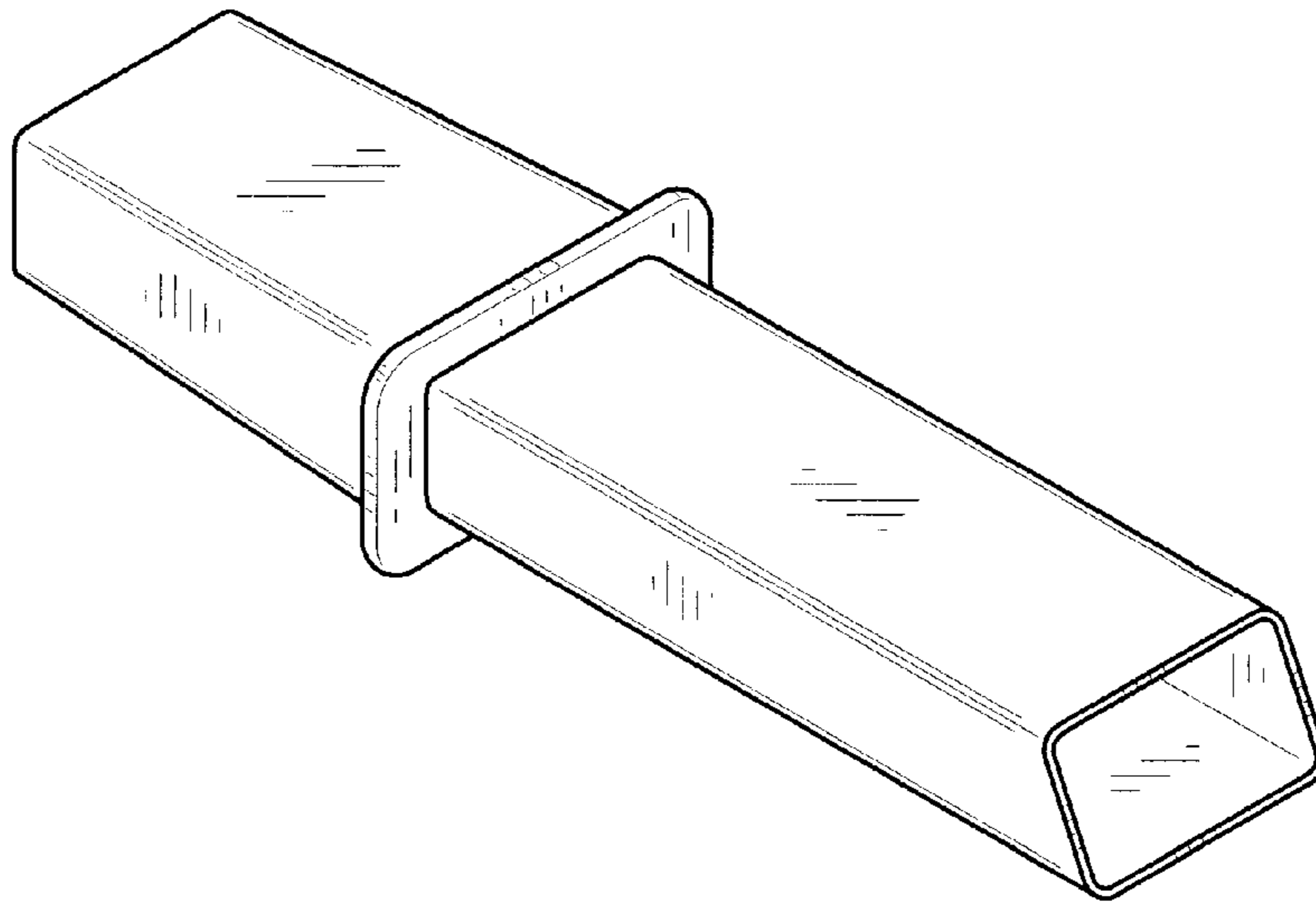

FIG. 13

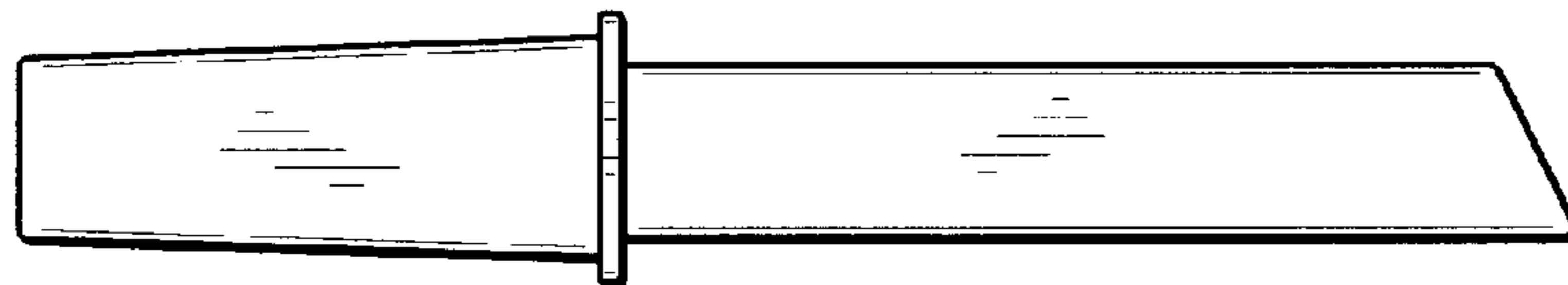

FIG. 14

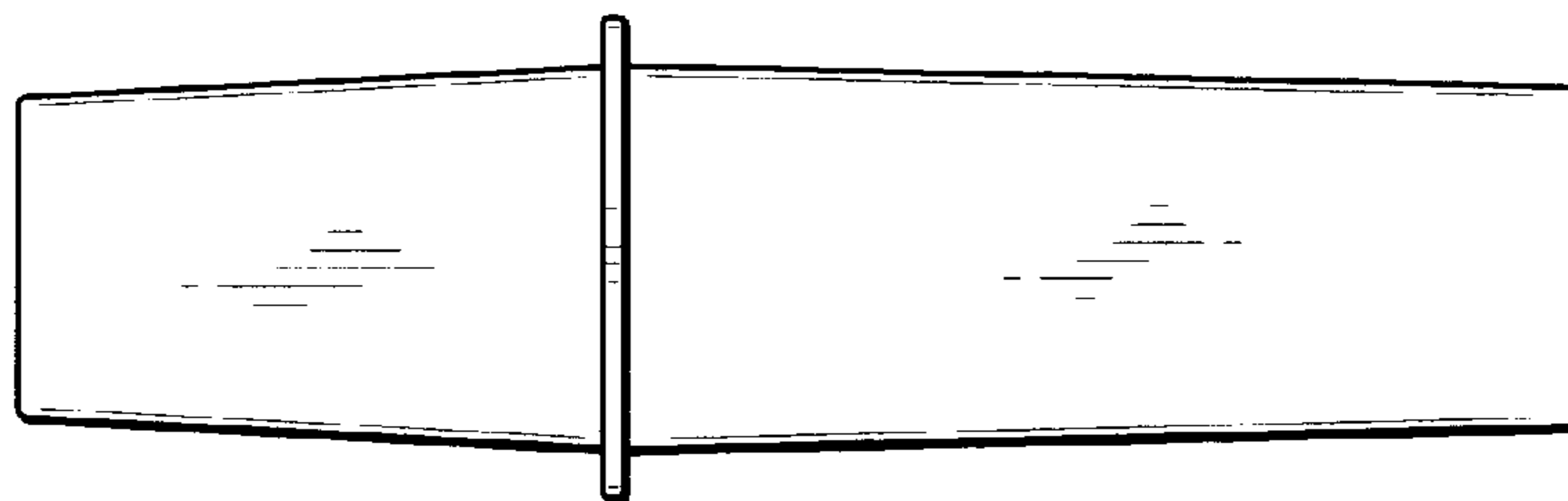

FIG. 15

