



US00D442988S

(12) **United States Design Patent**
Yoshida et al.

(10) **Patent No.:** **US D442,988 S**

(45) **Date of Patent:** **** May 29, 2001**

(54) **PRINTER**

D. 424,101 * 5/2000 Takeuchi D18/53
D. 425,551 * 5/2000 Shiozaki et al. D18/53

(75) Inventors: **Kenzoh Yoshida; Takaaki Kuwabara;**
Keiichi Takao, all of Nara-ken (JP)

* cited by examiner

(73) Assignee: **Sharp Kabushiki Kaisha**, Osaka (JP)

Primary Examiner—Melody N. Brown
(74) *Attorney, Agent, or Firm*—Nixon & Vanderhye

(**) Term: **14 Years**

(21) Appl. No.: **29/122,948**

(57) **CLAIM**

The ornamental design for a printer, as shown and described.

(22) Filed: **May 8, 2000**

(30) **Foreign Application Priority Data**

DESCRIPTION

Nov. 12, 1999 (JP) 11-31273

FIG. 1 is a top, front and right side perspective view of a printer according to our design;

(51) **LOC (7) Cl.** **18-02**

FIG. 2 is a top plan view thereof;

(52) **U.S. Cl.** **D18/53**

FIG. 3 is a bottom plan view thereof;

(58) **Field of Search** D18/50, 53-55,
D18/36; 400/613, 613.1-613.4, 690, 690.1-690.4,
691-694

FIG. 4 is a front elevational view thereof;

FIG. 5 is a rear elevational view thereof;

FIG. 6 is a right side elevational view thereof; and,

FIG. 7 is a left side elevational view thereof.

(56) **References Cited**

U.S. PATENT DOCUMENTS

D. 399,250 * 10/1998 Kawai D18/50

1 Claim, 7 Drawing Sheets

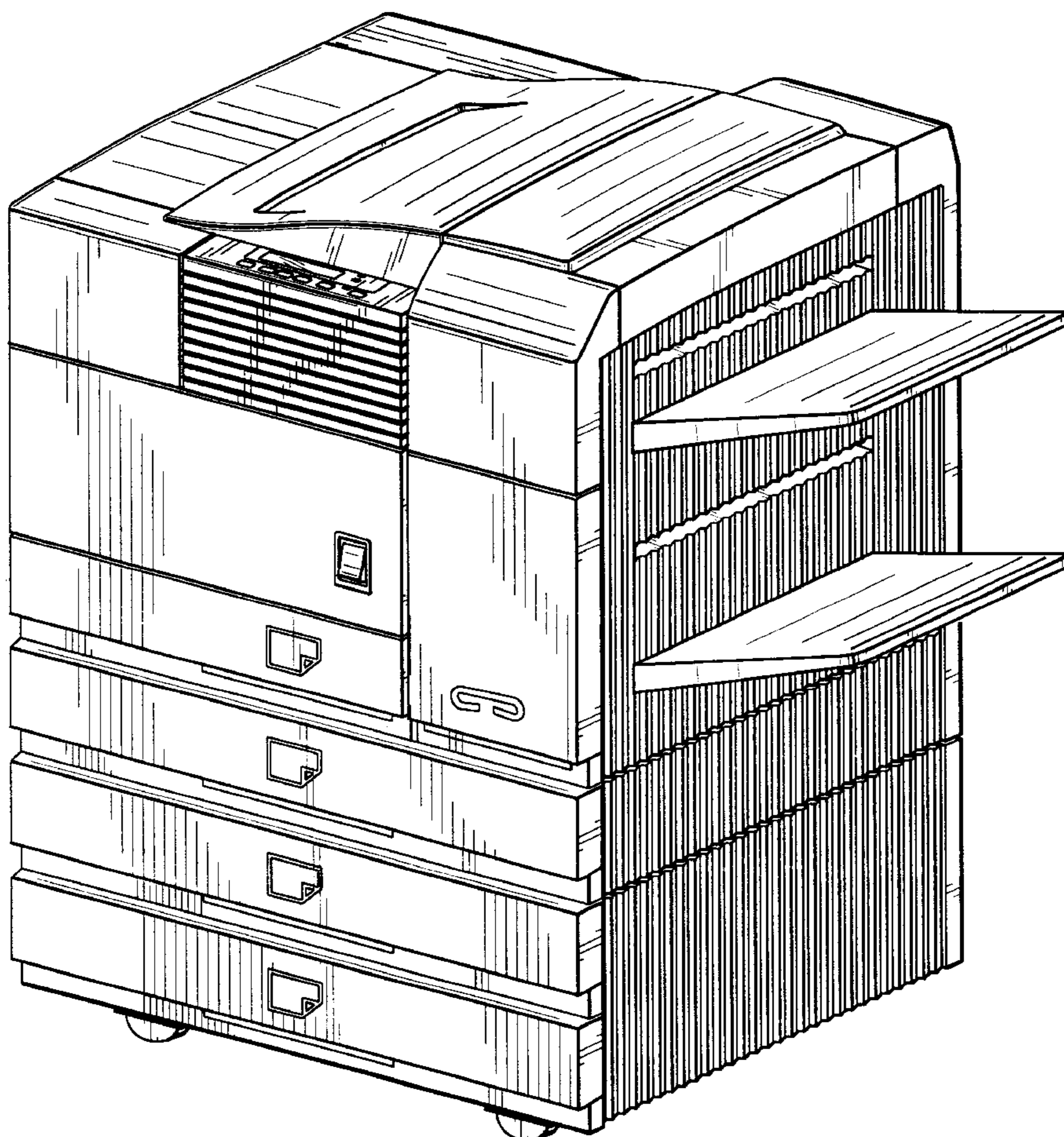

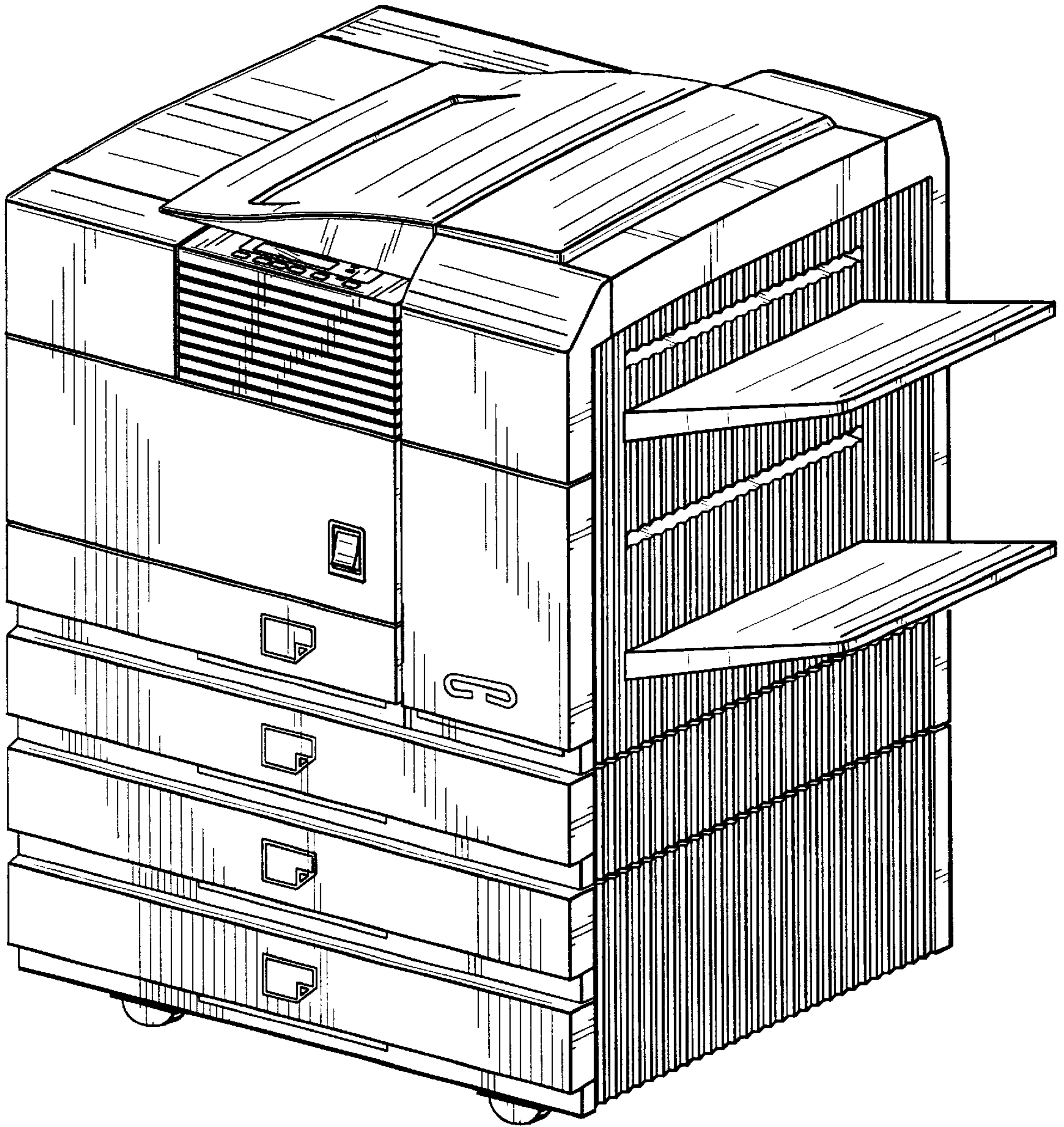

Fig.1

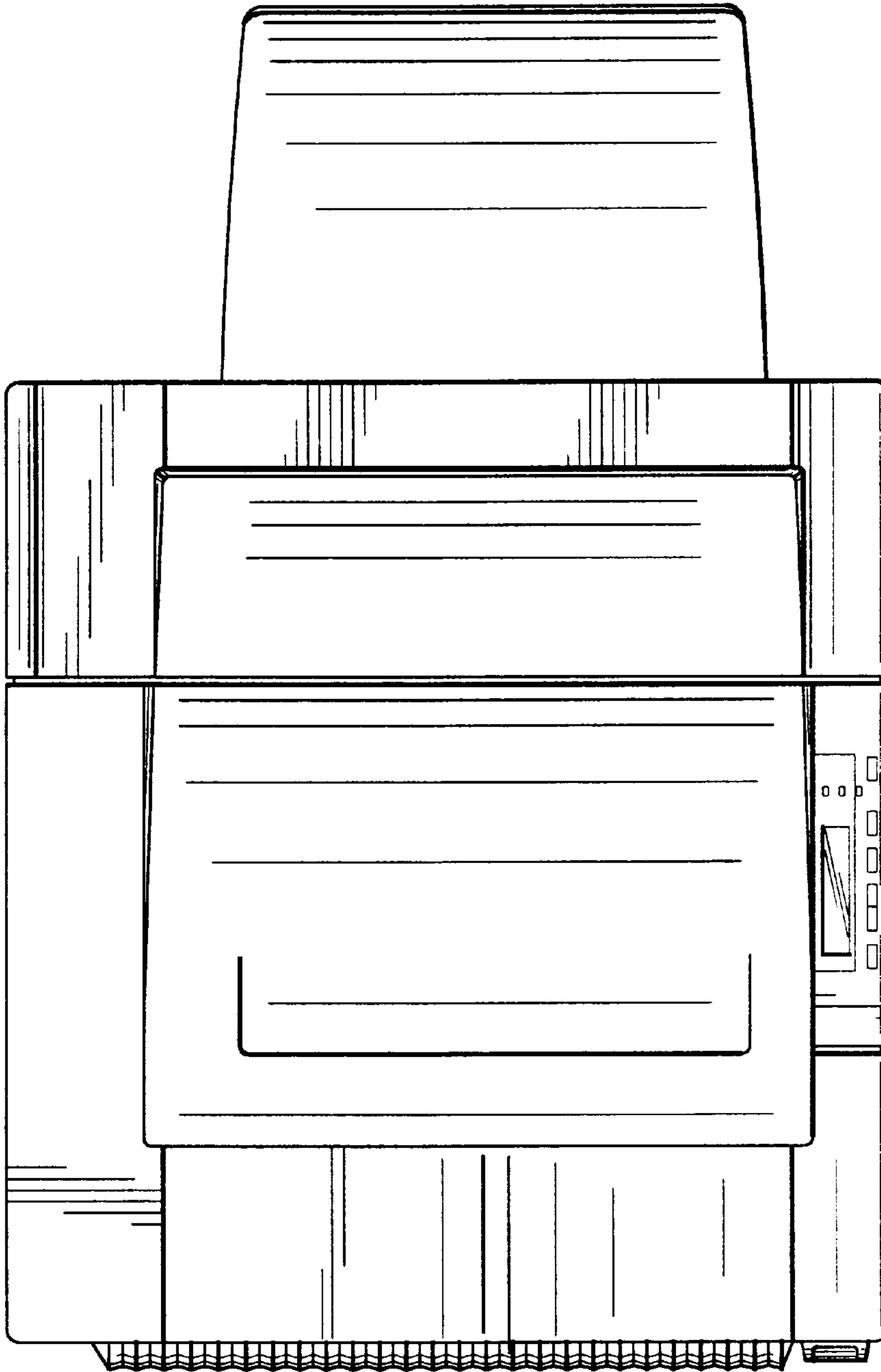

Fig.2

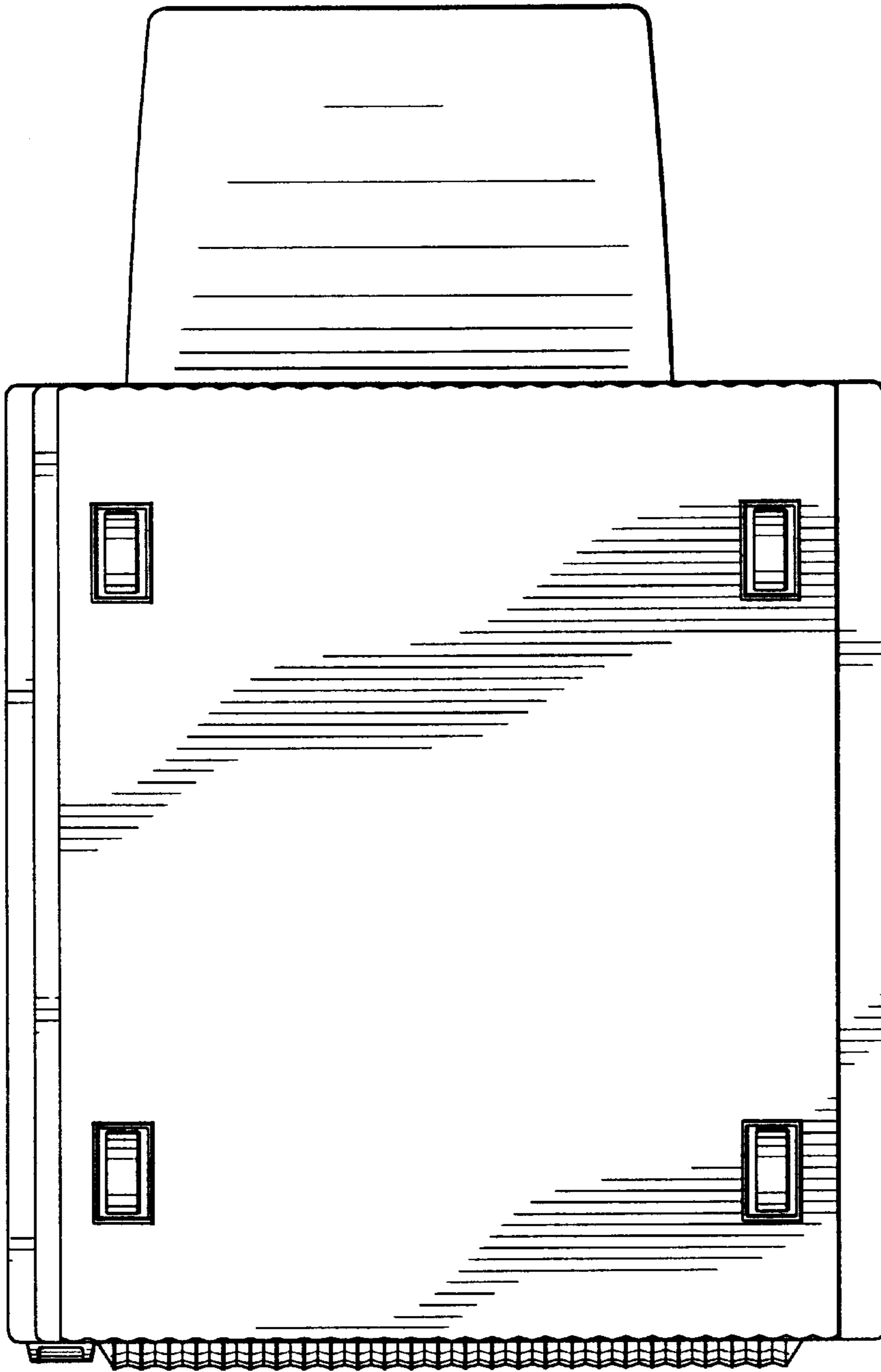

Fig.3

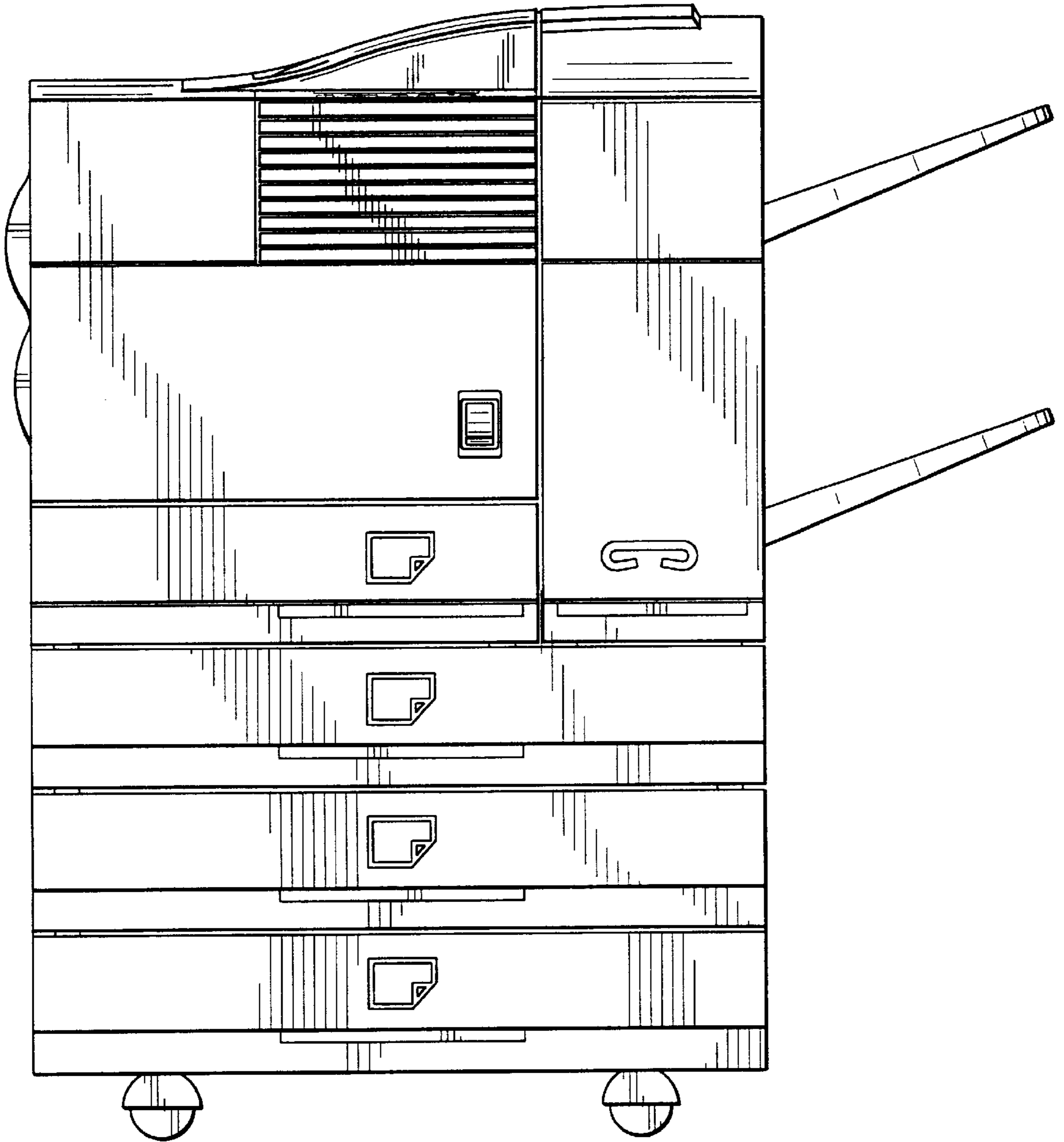

Fig.4

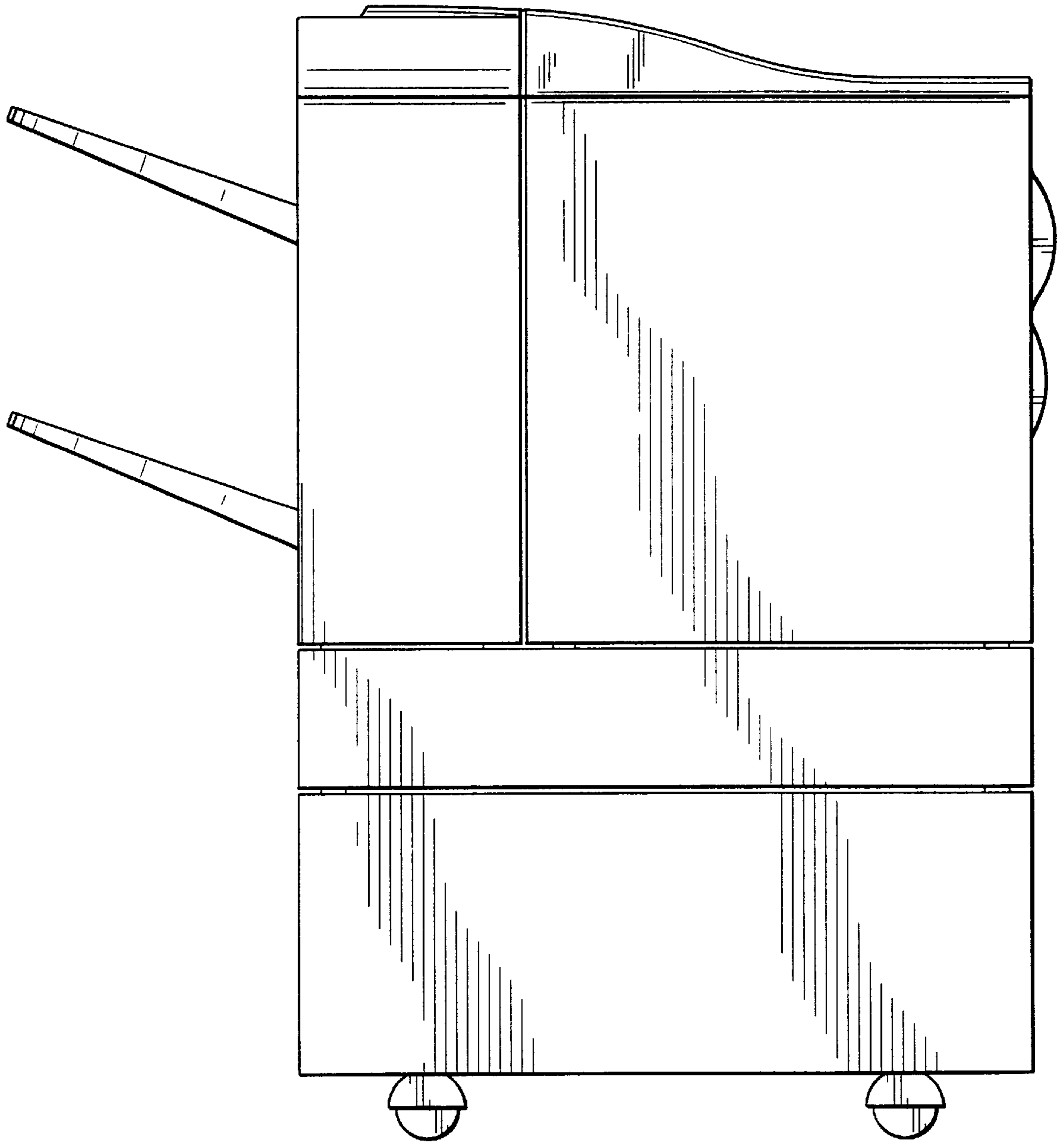

Fig.5

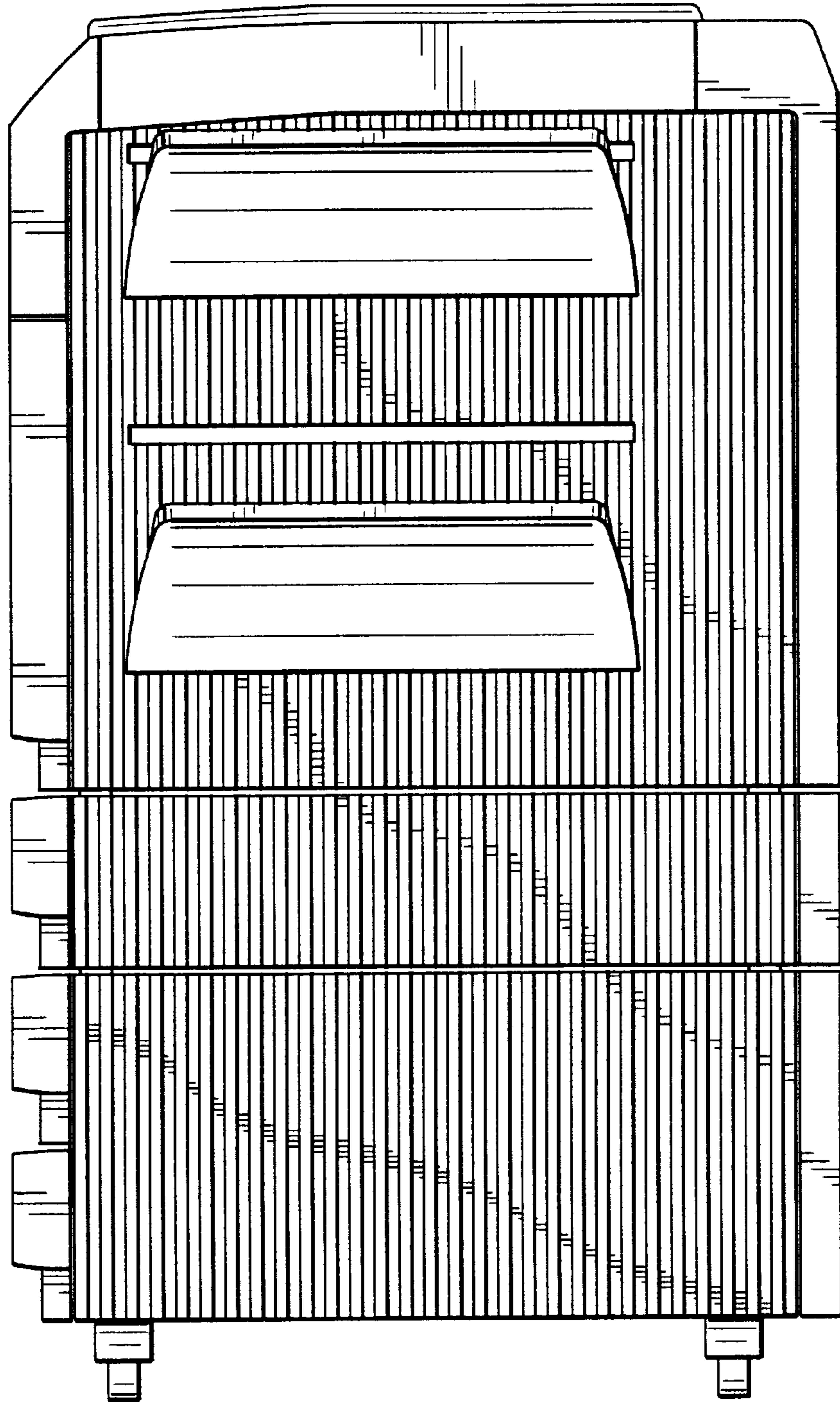

Fig.6

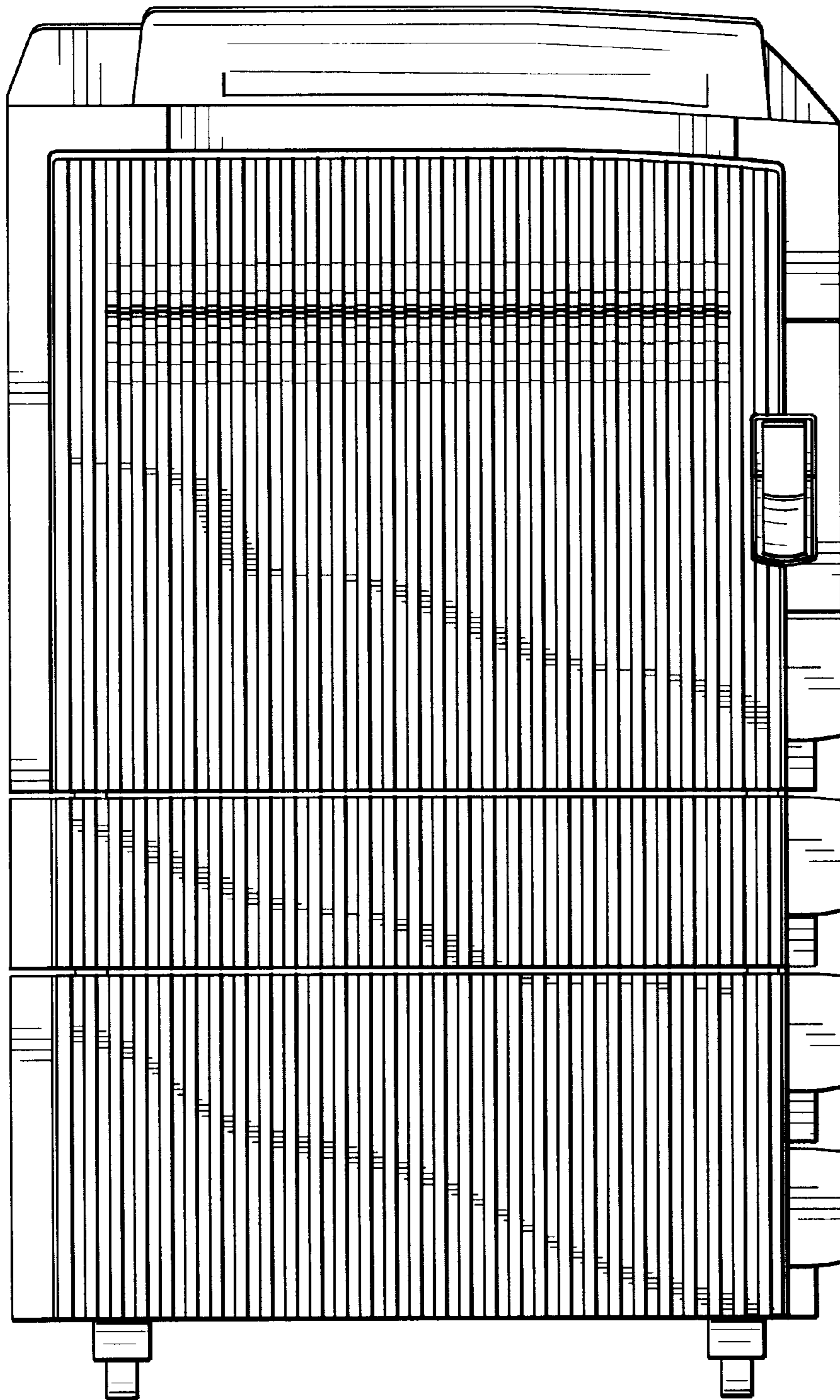

Fig.7