



US00D442946S

(12) **United States Design Patent**
Pohl et al.

(10) **Patent No.:** **US D442,946 S**

(45) **Date of Patent:** **** May 29, 2001**

(54) **MICROPHONE**

D. 395,893 * 7/1998 Hern et al. D14/228 X
D. 418,512 * 1/2000 Lin et al. D14/227

(75) Inventors: **John Phillip Pohl**, Lakes Forest;
Robert Edward Mudra, Glenview;
William Chamberlain, Palatine;
Jeffery Patrick Heuel, Elmhurst, all of
IL (US)

OTHER PUBLICATIONS

Catalog sheet of Turner Road King 56 and Road King 56B
Microphone.

* cited by examiner

(73) Assignee: **Cobra Electronics Corporation**,
Chicago, IL (US)

Primary Examiner—Nanda Bondade

(74) *Attorney, Agent, or Firm*—Wallenstein & Wagner, Ltd

(**) Term: **14 Years**

(57) **CLAIM**

(21) Appl. No.: **29/121,287**

The ornamental design for a microphone, as shown and
described.

(22) Filed: **Apr. 4, 2000**

DESCRIPTION

(51) **LOC (7) Cl.** **14-01**

(52) **U.S. Cl.** **D14/225**

(58) **Field of Search** D14/225-229;
181/158, 242; 381/26, 91, 111, 122, 189,
338, 353, 369

FIG. 1 is a top and front perspective view of a microphone
showing our new design;

FIG. 2 is a bottom and front perspective view thereof;

FIG. 3 is a top and rear perspective view thereof;

FIG. 4 is a bottom and rear perspective view thereof;

FIG. 5 is a bottom and front perspective view thereof;

FIG. 6 is a bottom and right perspective view thereof;

FIG. 7 is a bottom and left perspective view thereof; and,

FIG. 8 is a bottom and right perspective view thereof.

(56) **References Cited**

U.S. PATENT DOCUMENTS

D. 195,960 * 8/1963 Spilman D14/225
D. 355,915 * 2/1995 Chan D14/229 X
D. 385,281 * 10/1997 Volan et al. D14/227

1 Claim, 1 Drawing Sheet

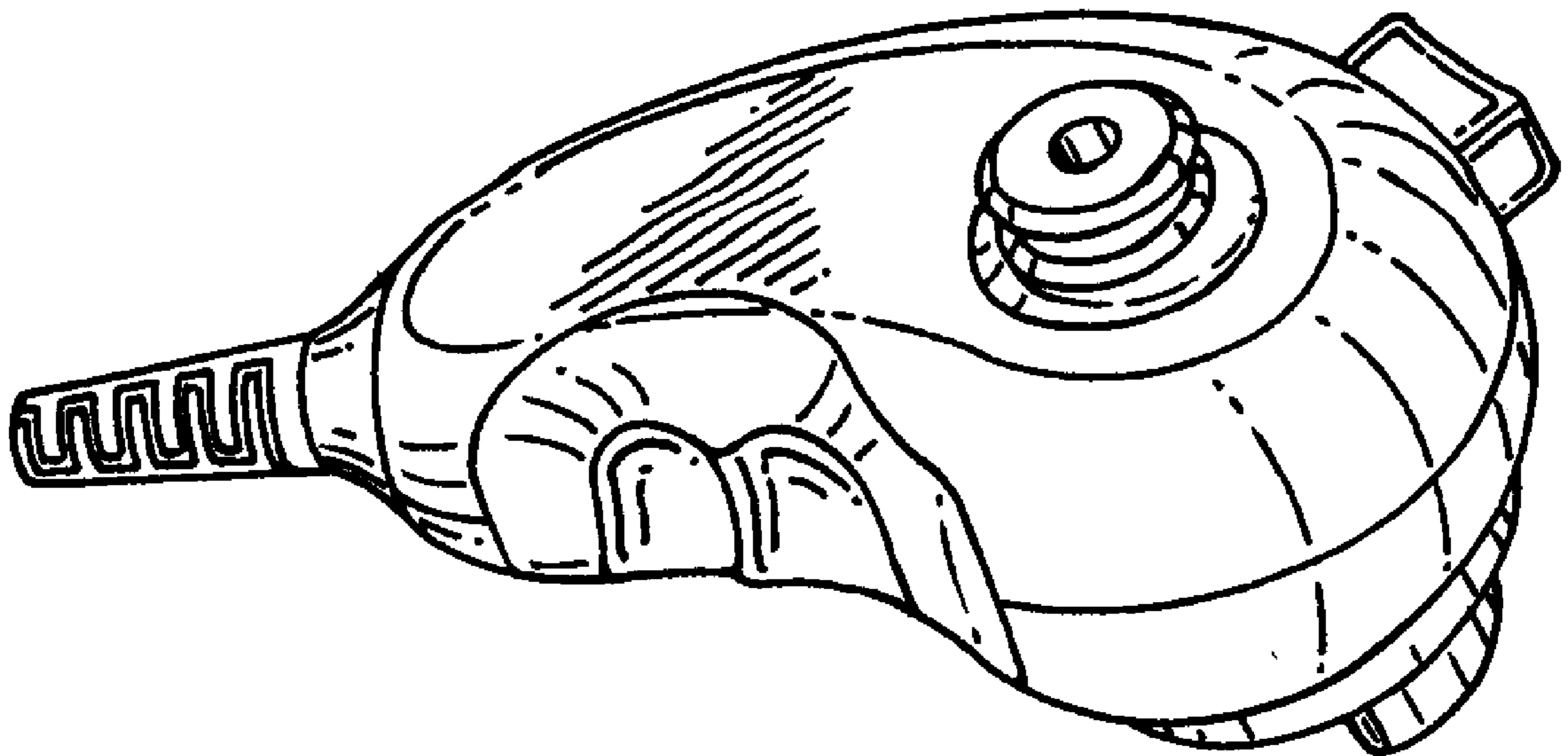

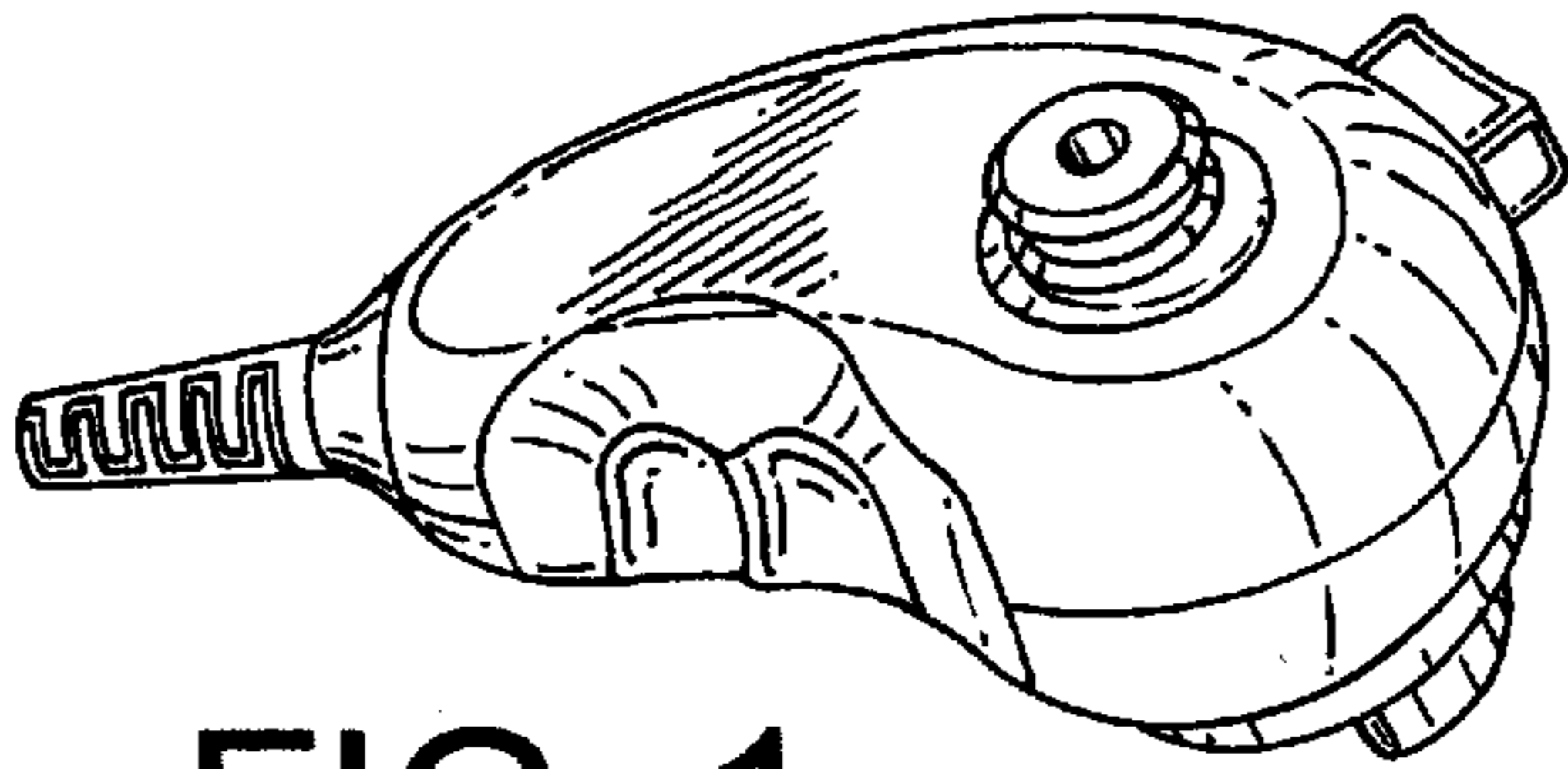

FIG. 1

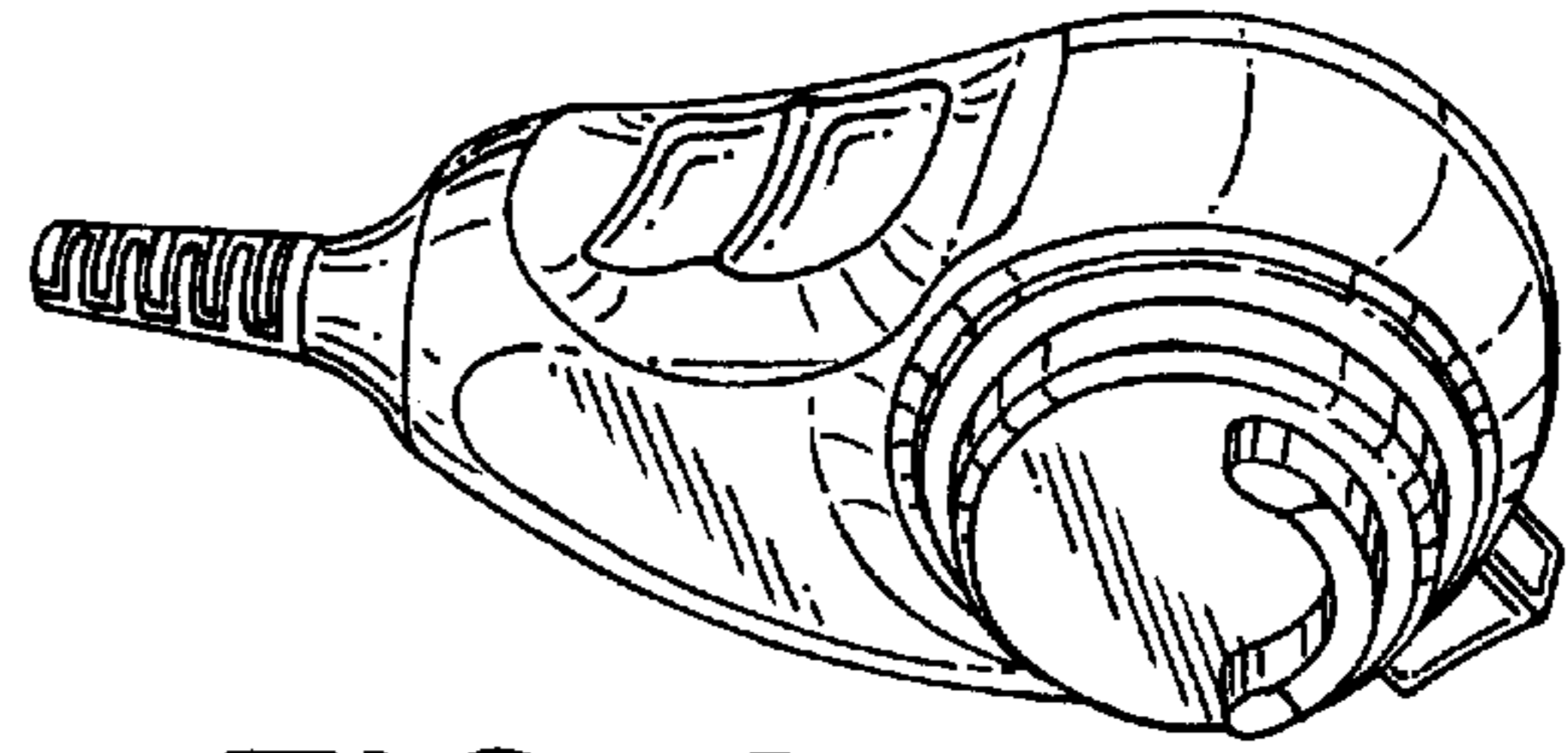

FIG. 2

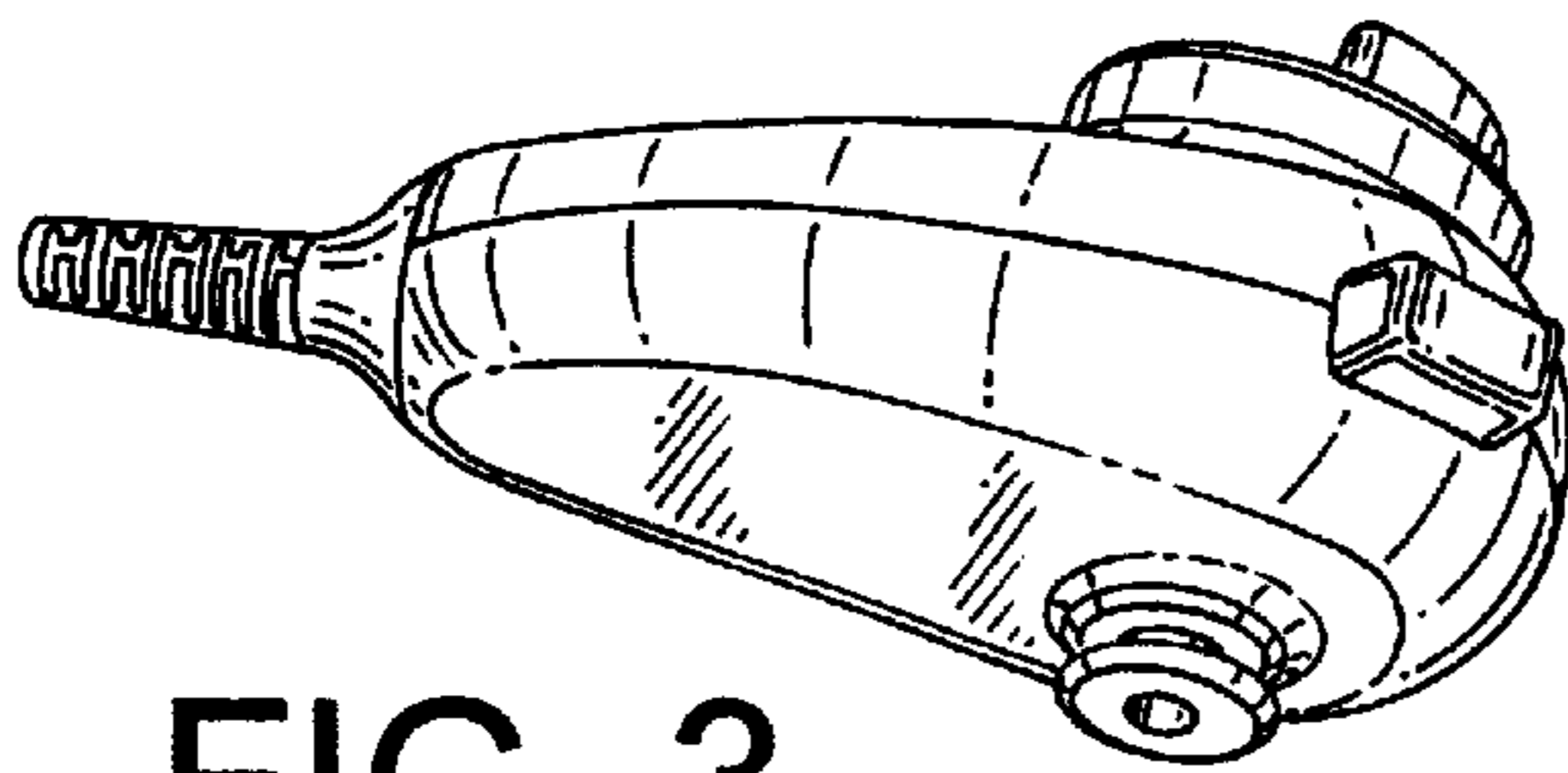

FIG. 3

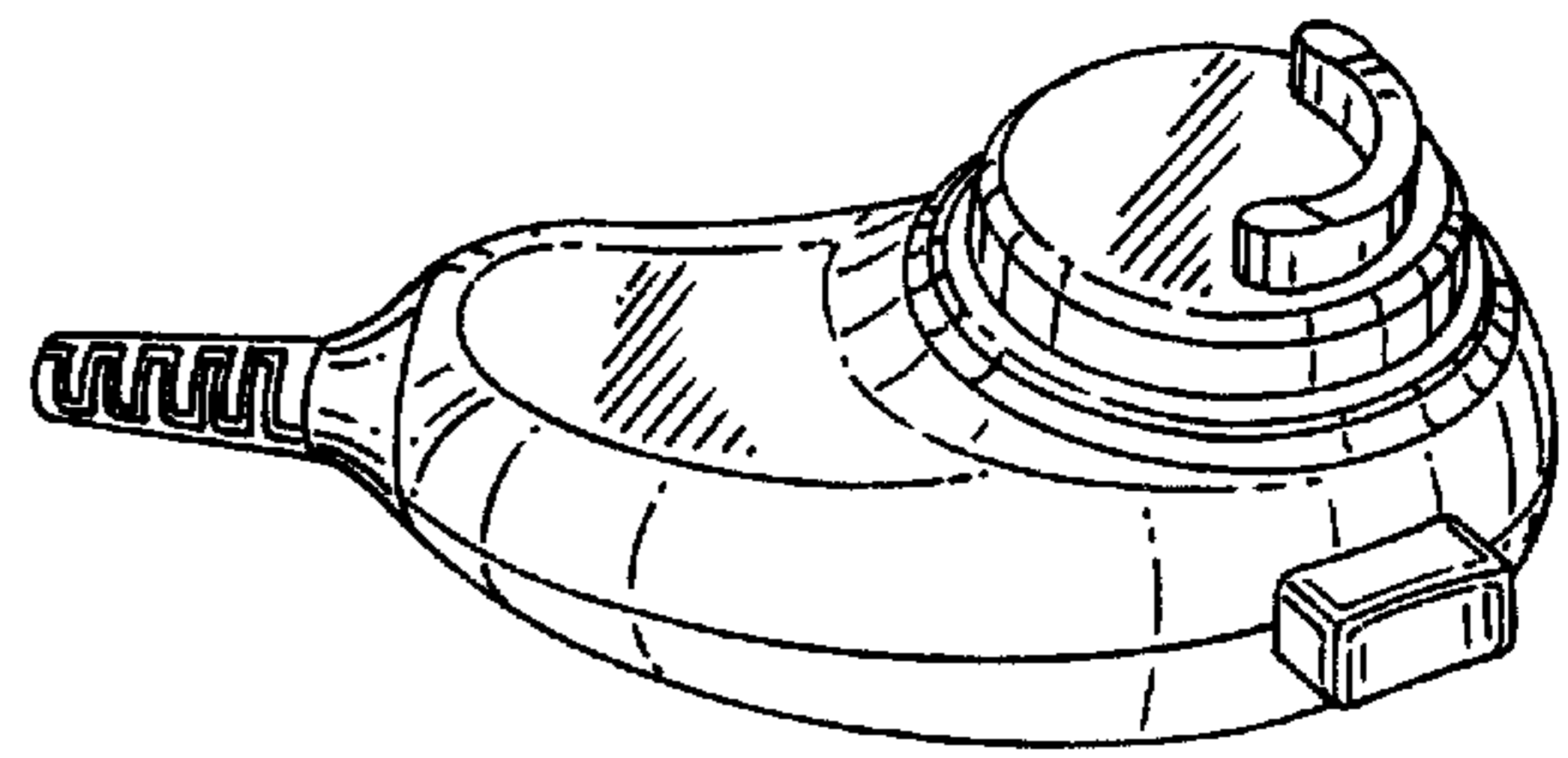

FIG. 4

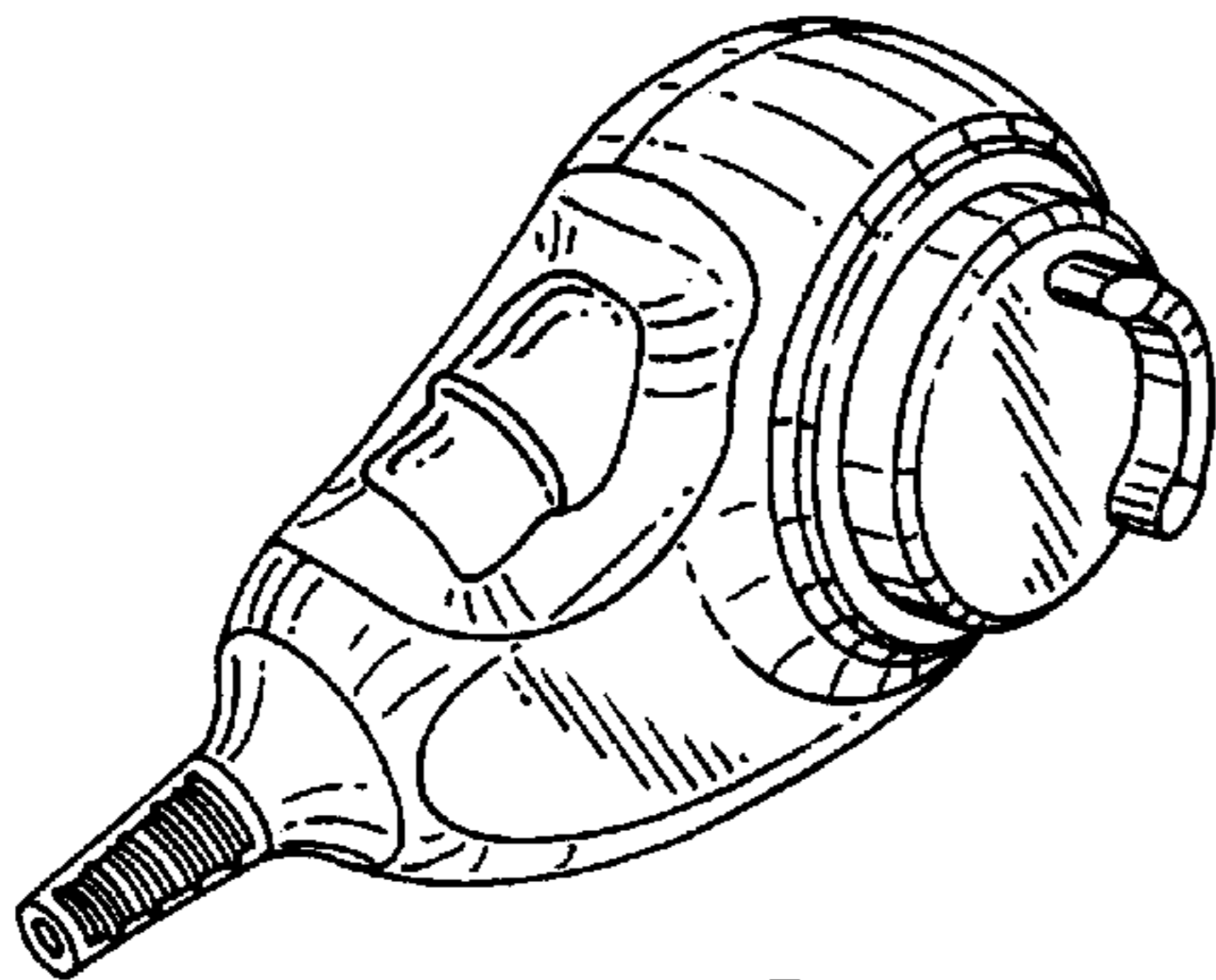

FIG. 5

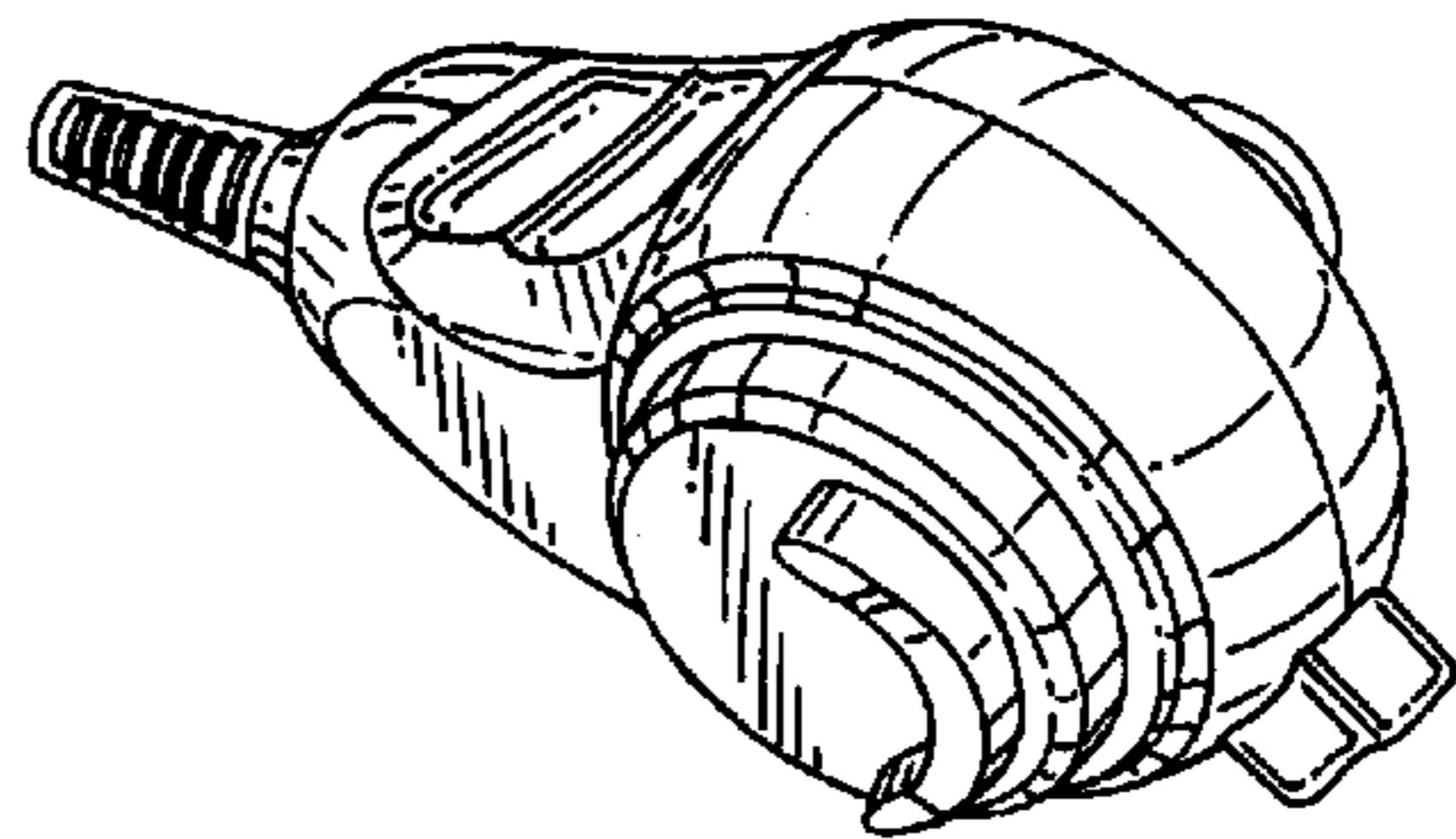

FIG. 6

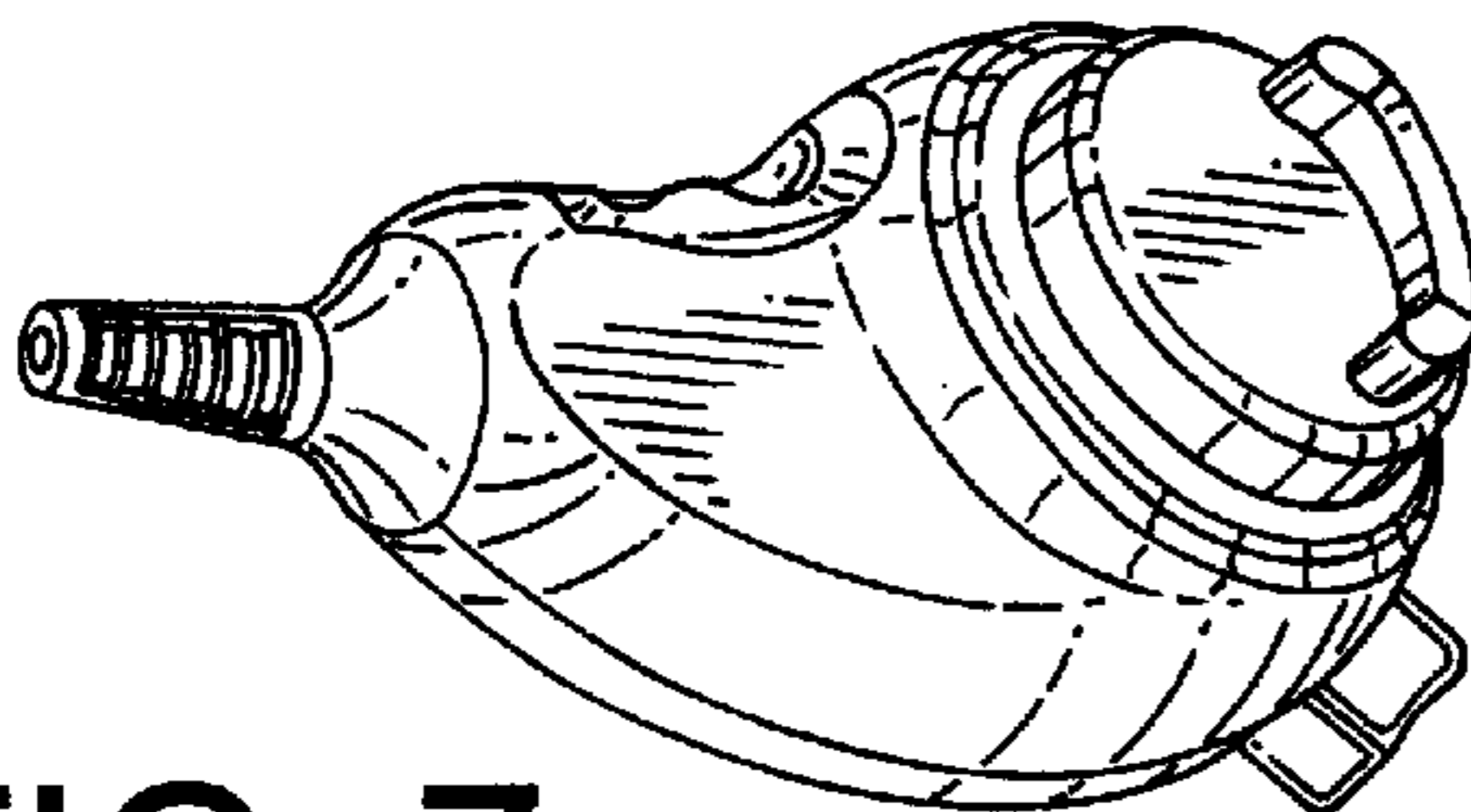

FIG. 7

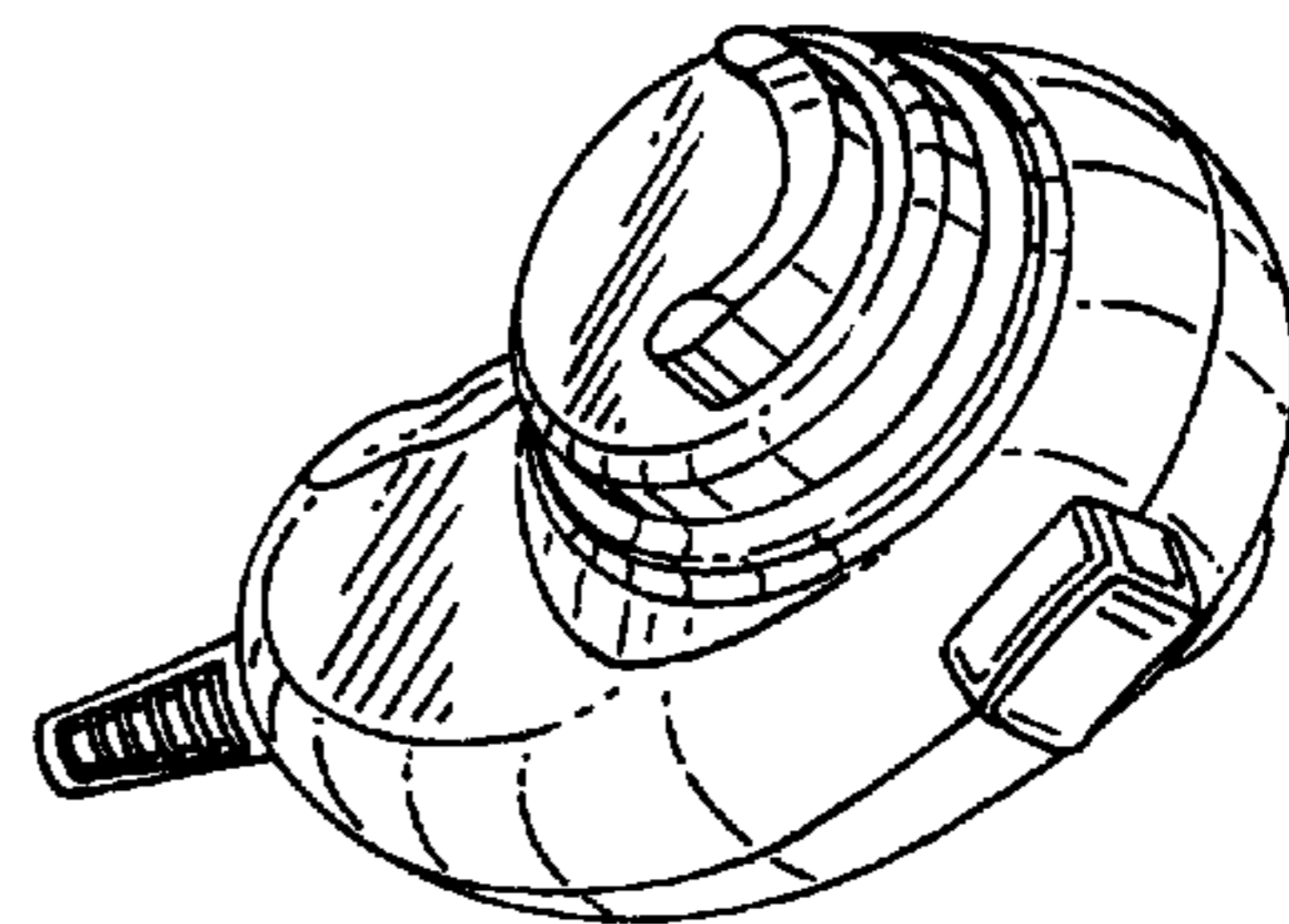

FIG. 8