



US00D442922S

(12) **United States Design Patent**  
**Sato**

(10) **Patent No.:** **US D442,922 S**

(45) **Date of Patent:** **\*\* May 29, 2001**

(54) **PORTION OF A FREQUENCY CHANGER**

**FOREIGN PATENT DOCUMENTS**

(75) Inventor: **Atsushi Sato**, Ibaraki-ken (JP)

924629 5/1995 (JP) .  
1006918 4/1998 (JP) .

(73) Assignee: **Kabushiki Kaisha Toshiba**, Kawasaki (JP)

**OTHER PUBLICATIONS**

(\*\*) Term: **14 Years**

9600 USY, Nihon Alcatel Kabushiki Kaisha, (Prior to Oct. 19, 1999).

(21) Appl. No.: **29/121,911**

\* cited by examiner

(22) Filed: **Apr. 18, 2000**

*Primary Examiner*—Brian N. Vinson

(30) **Foreign Application Priority Data**

(74) *Attorney, Agent, or Firm*—Banner & Witcoff, Ltd.

Oct. 19, 1999 (JP) ..... 11-28662

(51) **LOC (7) Cl.** ..... **13-03**

(52) **U.S. Cl.** ..... **D13/177; D13/156; D13/152**

(58) **Field of Search** ..... D13/177, 158,  
D13/162, 184, 123, 133, 147, 146, 156,  
152; 361/686; 307/147, 115, 116, 125;  
439/578, 579, 639; 333/100, 101, 105

(57) **CLAIM**

The ornamental design for a portion of a frequency changer, as shown and described.

(56) **References Cited**

**DESCRIPTION**

**U.S. PATENT DOCUMENTS**

- D. 358,753 \* 5/1995 Yoshida et al. .... D13/123
- D. 400,506 \* 11/1998 Mahoney ..... D13/146
- D. 400,512 \* 11/1998 Korhonen ..... D13/184
- D. 401,568 \* 11/1998 Alden et al. .... D13/184
- D. 416,232 \* 11/1999 Einck ..... D13/152
- D. 421,598 \* 3/2000 Berusha et al. .... D13/184
- 5,677,578 10/1997 Tang .
- 5,814,905 9/1998 Tang .
- 6,133,939 \* 10/2000 Gresko et al. .... 439/579 X

FIG. 1 is a top, front and right side perspective view of a portion of a frequency changer showing my new design, FIG. 2 is a front elevational view thereof, FIG. 3 is a top plan view thereof, FIG. 4 is a bottom plan view thereof, FIG. 5 is a left side elevational view thereof, FIG. 6 is a right side elevational view thereof; and, FIG. 7 is a reference view showing the article in use thereof. The broken line showing of the remainder of the frequency changer is for illustrative purposes only and forms no part of the claimed design. Also, the broken line showing of reference environment in FIG. 7 is for illustrative purposes only and forms no part of the claimed design.

**1 Claim, 3 Drawing Sheets**

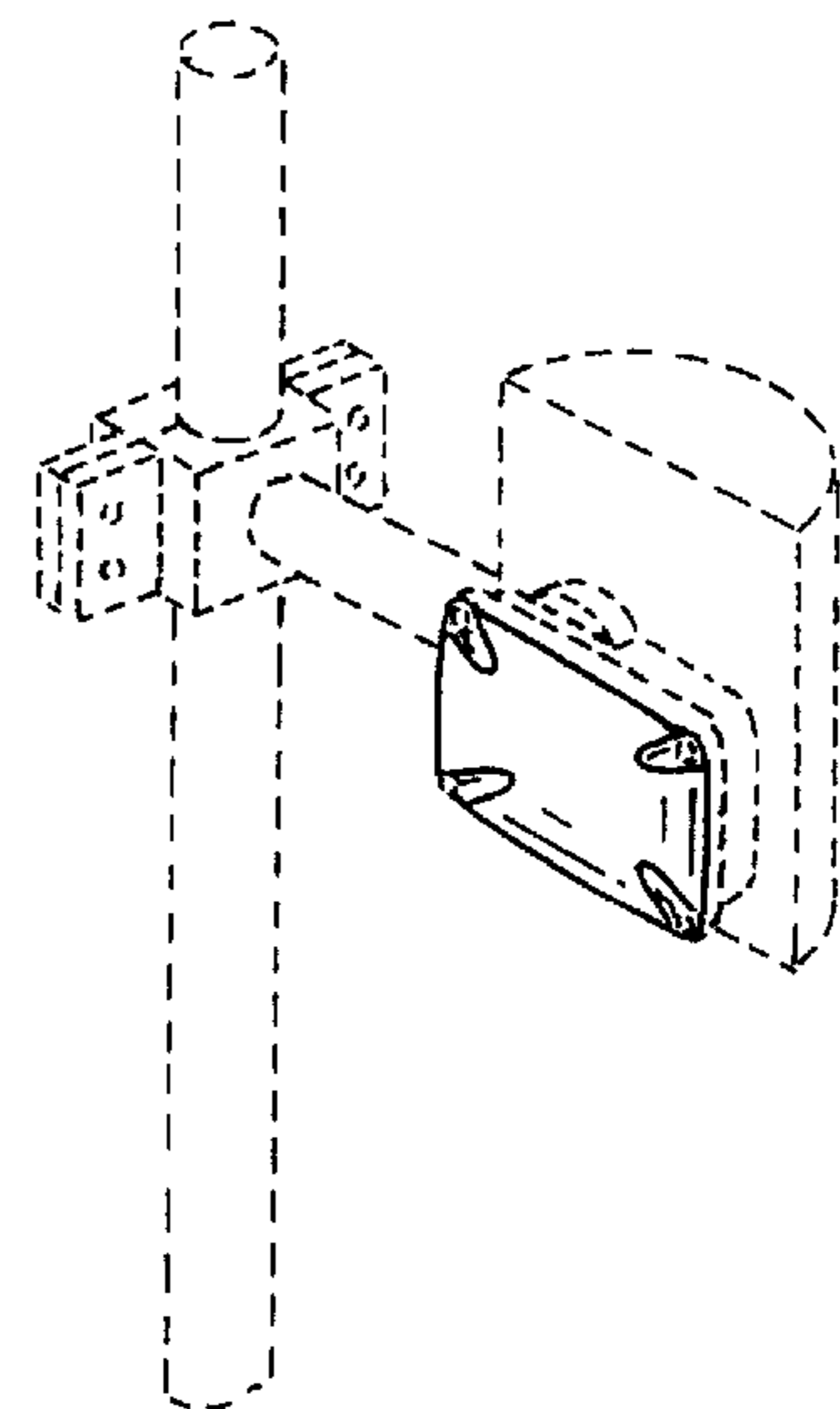
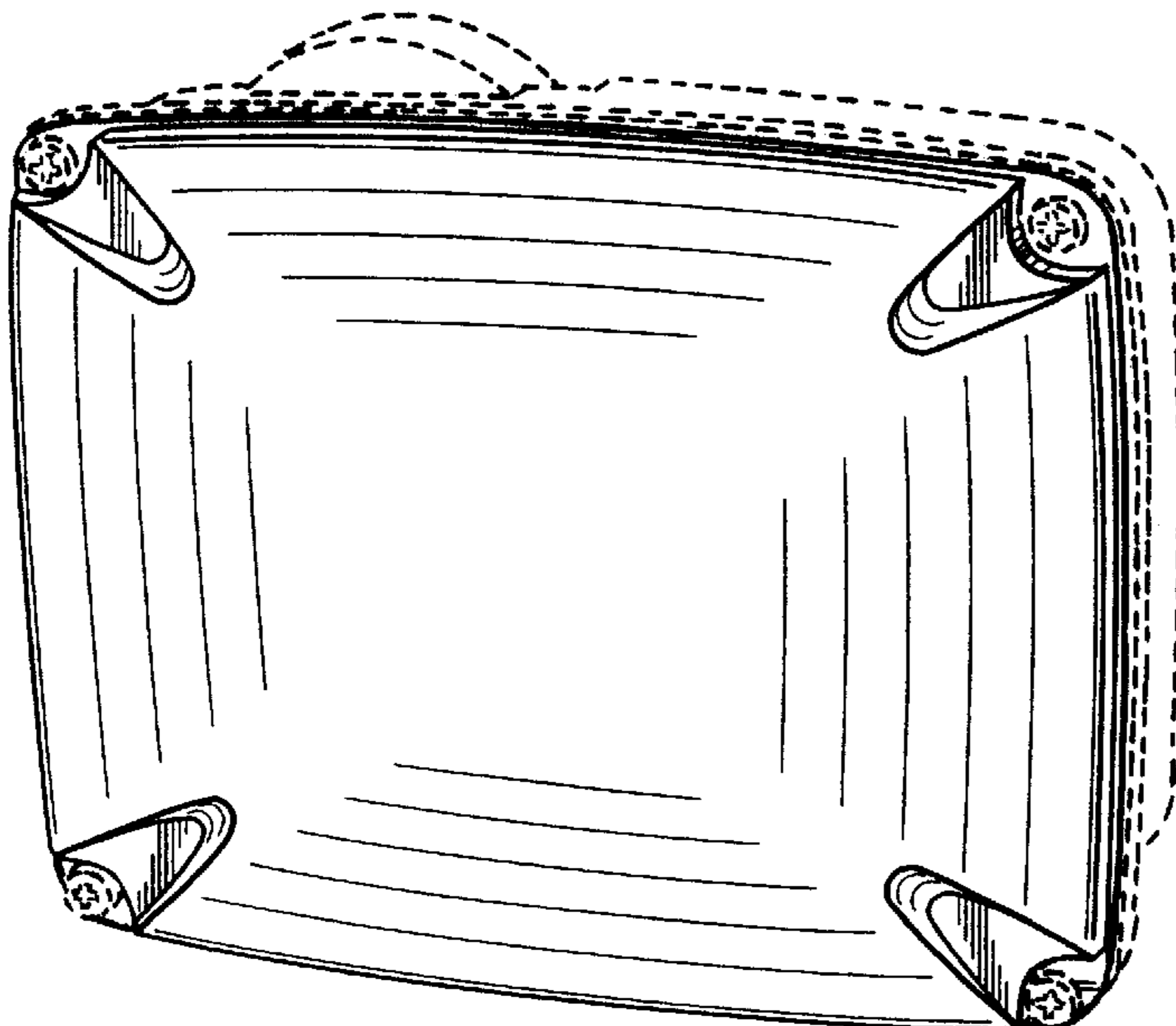

FIG. 1

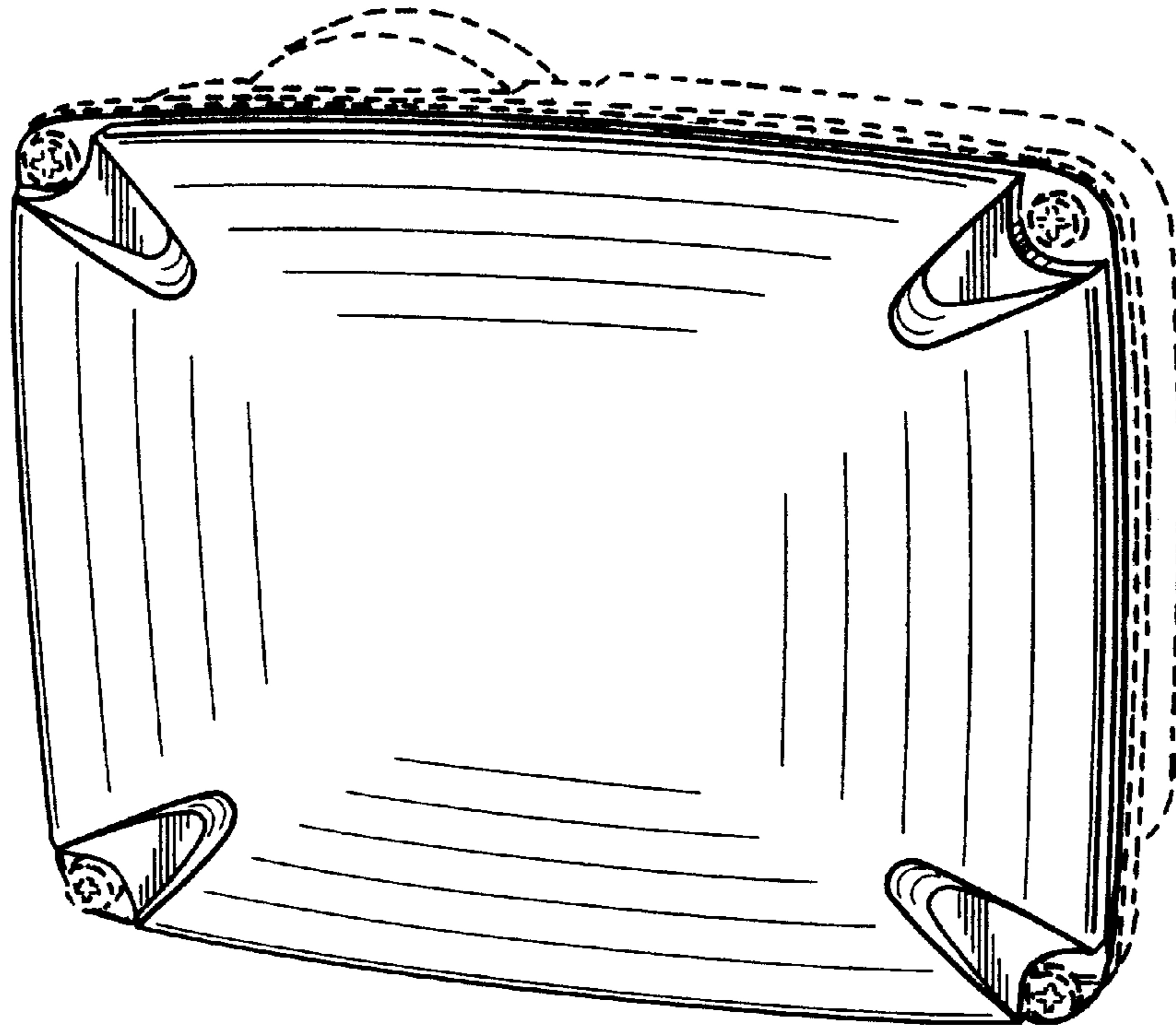

FIG. 2

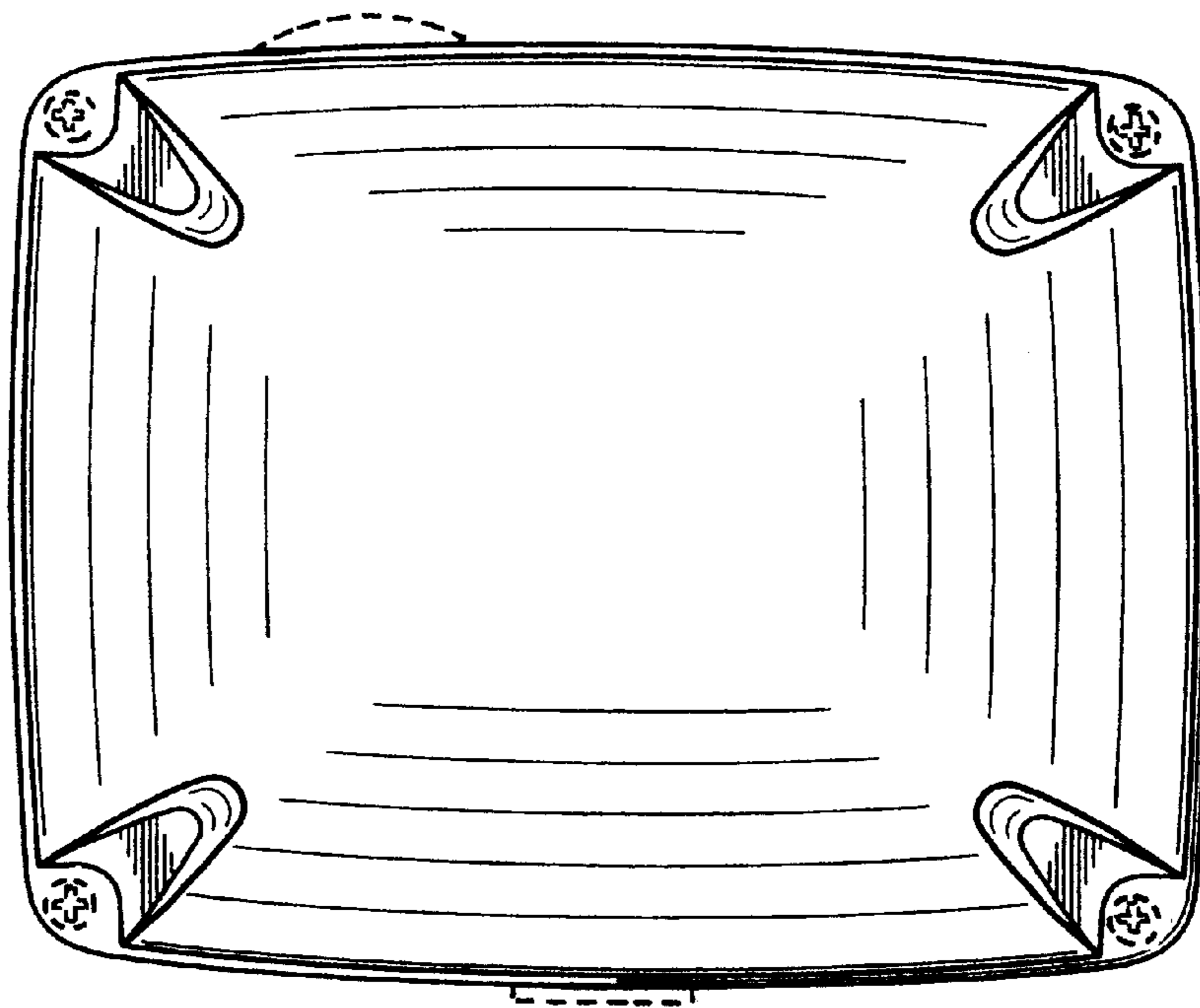

FIG. 3

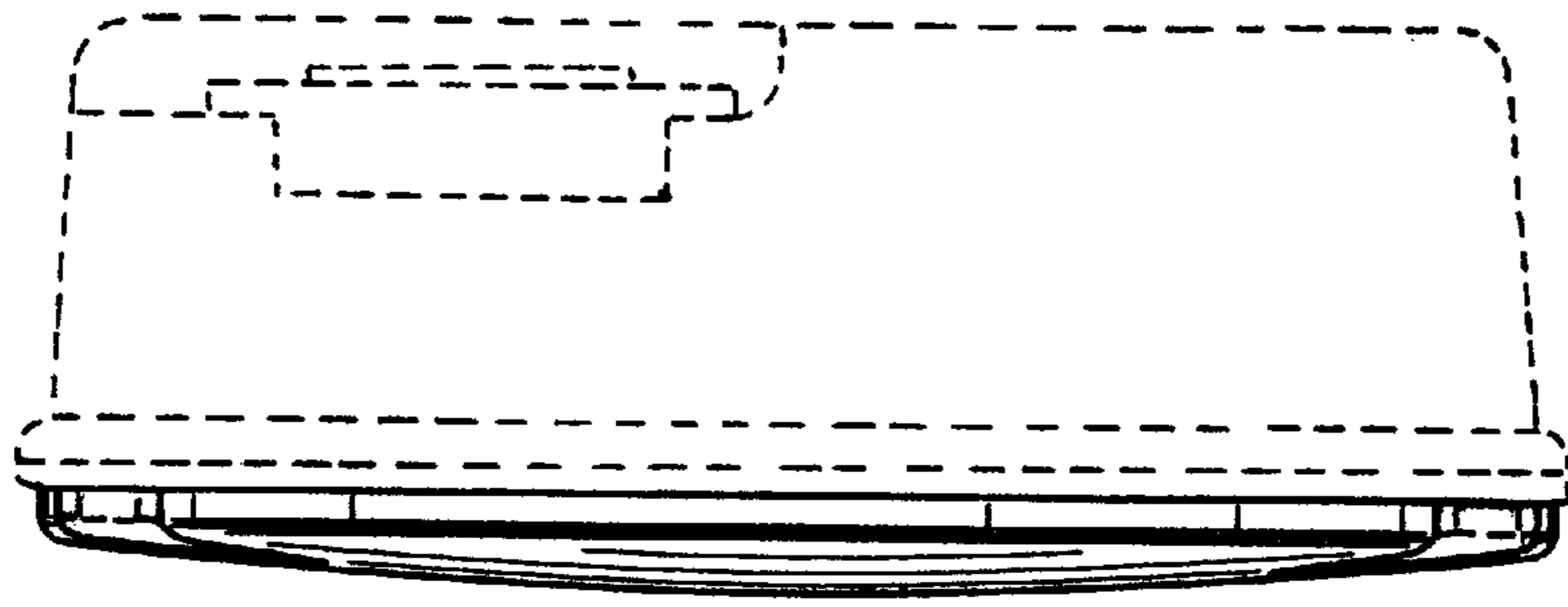

FIG. 4

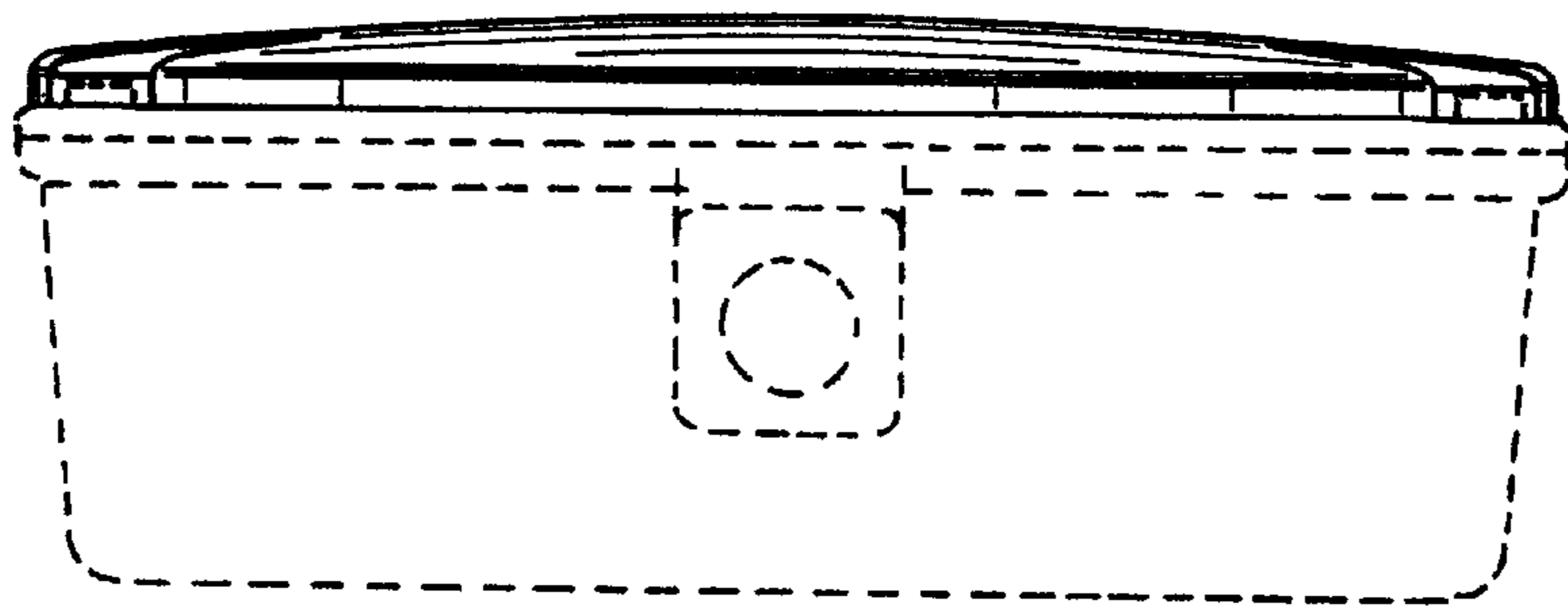

FIG. 5

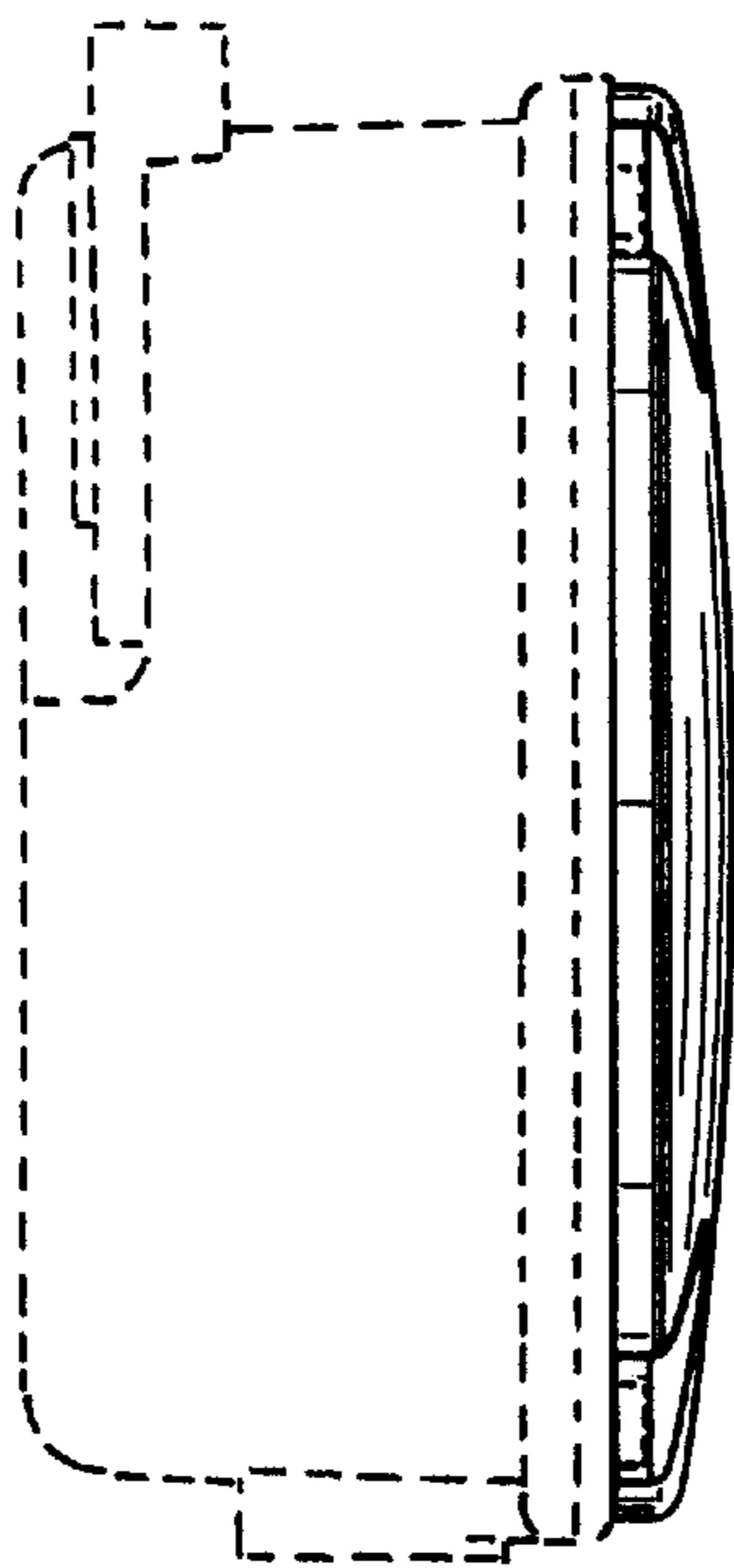
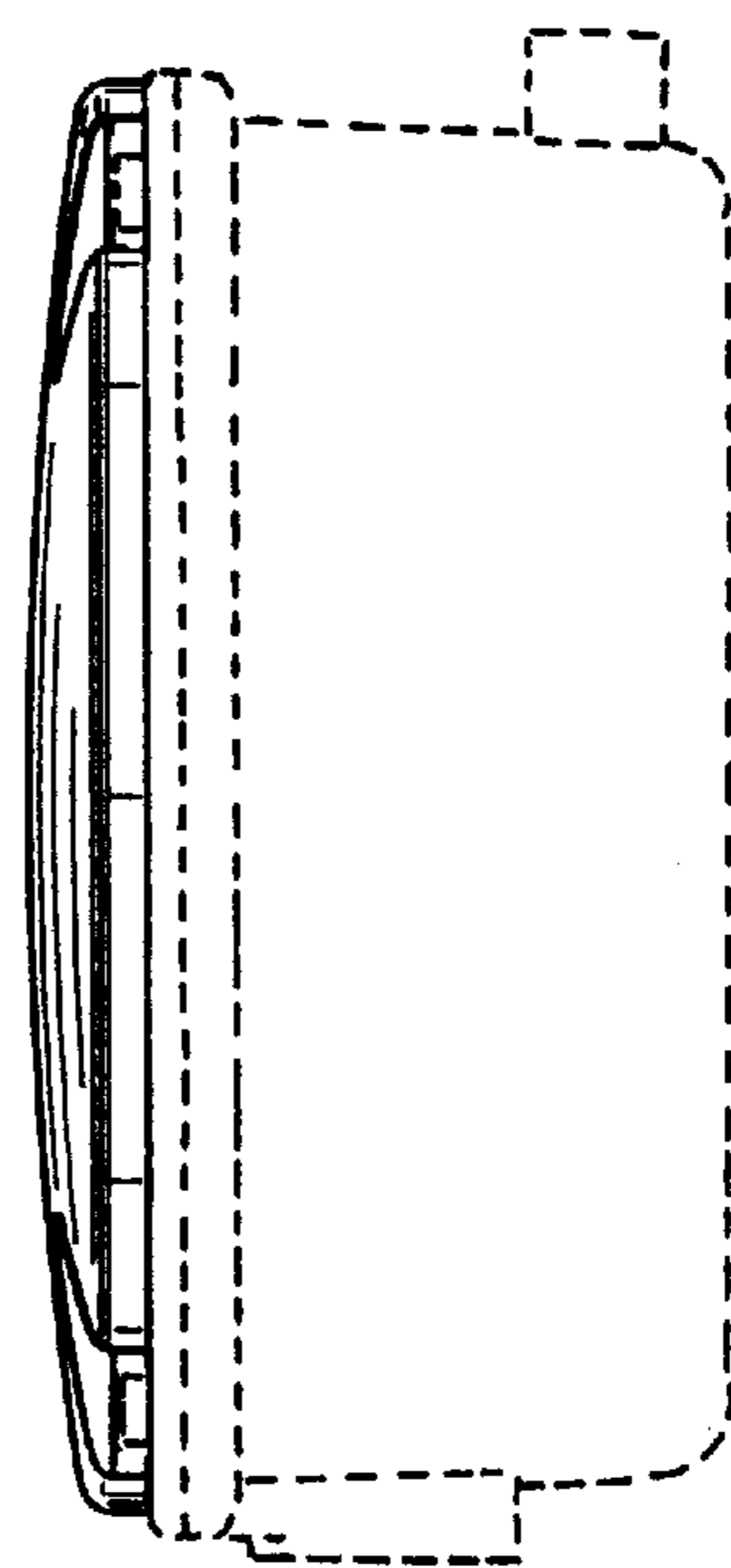

FIG. 6



# FIG. 7

