



US00D442806S

(12) **United States Design Patent**
Stravitz

(10) **Patent No.:** **US D442,806 S**

(45) **Date of Patent:** **** May 29, 2001**

(54) **ORGANIZER RACK**

(76) **Inventor:** **David M. Stravitz**, 16 Park Ave. -
Suite 14A, New York, NY (US) 10016

(**) **Term:** **14 Years**

(21) **Appl. No.:** **29/115,131**

(22) **Filed:** **Dec. 8, 1999**

(51) **LOC (7) Cl.** **06-04**

(52) **U.S. Cl.** **D6/479; D6/477; D6/509**

(58) **Field of Search** D6/396, 397, 418,
D6/449, 462, 475-477, 479, 509-511, 567,
569-572, 574, 512; D19/75, 77, 86, 90-92,
95; D28/73; D3/304, 313, 314, 319; 211/10,
11, 50, 45, 51, 40, 87.01, 88.01, 119.003,
119.005, 119.009, 134, 135, 186, 188, 189,
194; 108/59, 60, 64, 91, 180, 158, 12; 206/214,
215, 557, 561, 577, 504, 509; 220/23.4,
23.83, 553-555; 312/107, 108, 111, 257.1,
263, 264

(56) **References Cited**

U.S. PATENT DOCUMENTS

- D. 283,957 * 5/1986 Stravitz D6/407
- D. 289,833 * 5/1987 Stravitz D6/407

- D. 297,189 * 8/1988 Stravitz D6/407
- D. 408,858 * 4/1999 Stravitz D19/75
- D. 413,749 * 9/1999 Stravitz D6/567
- 3,807,572 * 4/1974 Luvara et al. 211/10
- 3,827,570 * 8/1974 Betts 211/10
- 4,440,299 * 4/1984 Peinecke 206/387.1

* cited by examiner

Primary Examiner—Catherine Tuttle
(74) *Attorney, Agent, or Firm*—Frishauf, Holtz, Goodman,
Langer & Chick, P.C.

(57) **CLAIM**

The ornamental design for an organizer rack, as shown and described.

DESCRIPTION

FIG. 1 is a top, front, right-side perspective view of an organizer rack showing my new design;
FIG. 2 is a front elevational view thereof;
FIG. 3 is a right side elevational view thereof, the left side elevational view being a mirror image thereof;
FIG. 4 is a rear elevational view thereof;
FIG. 5 is a top plan view thereof; and,
FIG. 6 is a bottom plan view thereof.

1 Claim, 2 Drawing Sheets

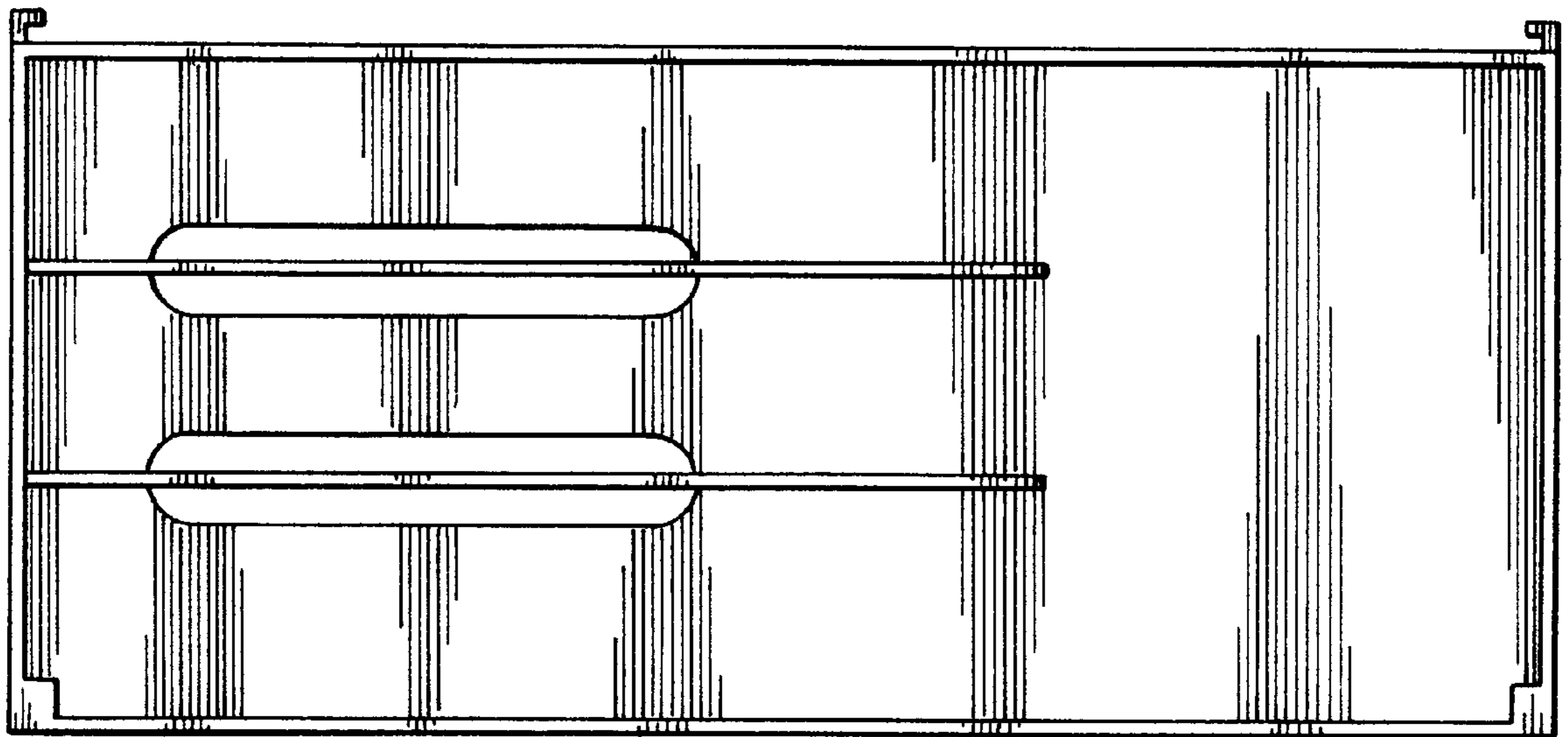

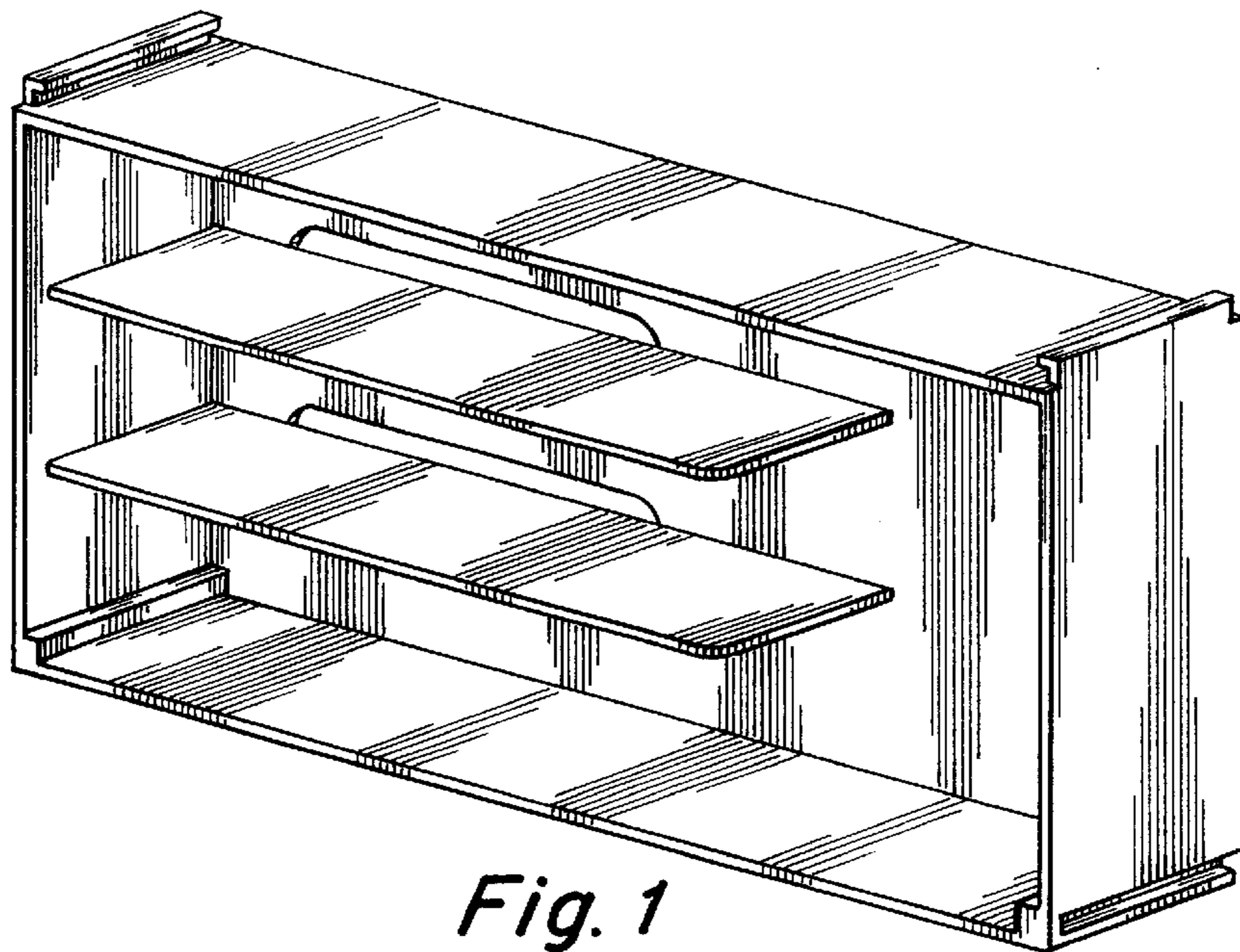

Fig. 1

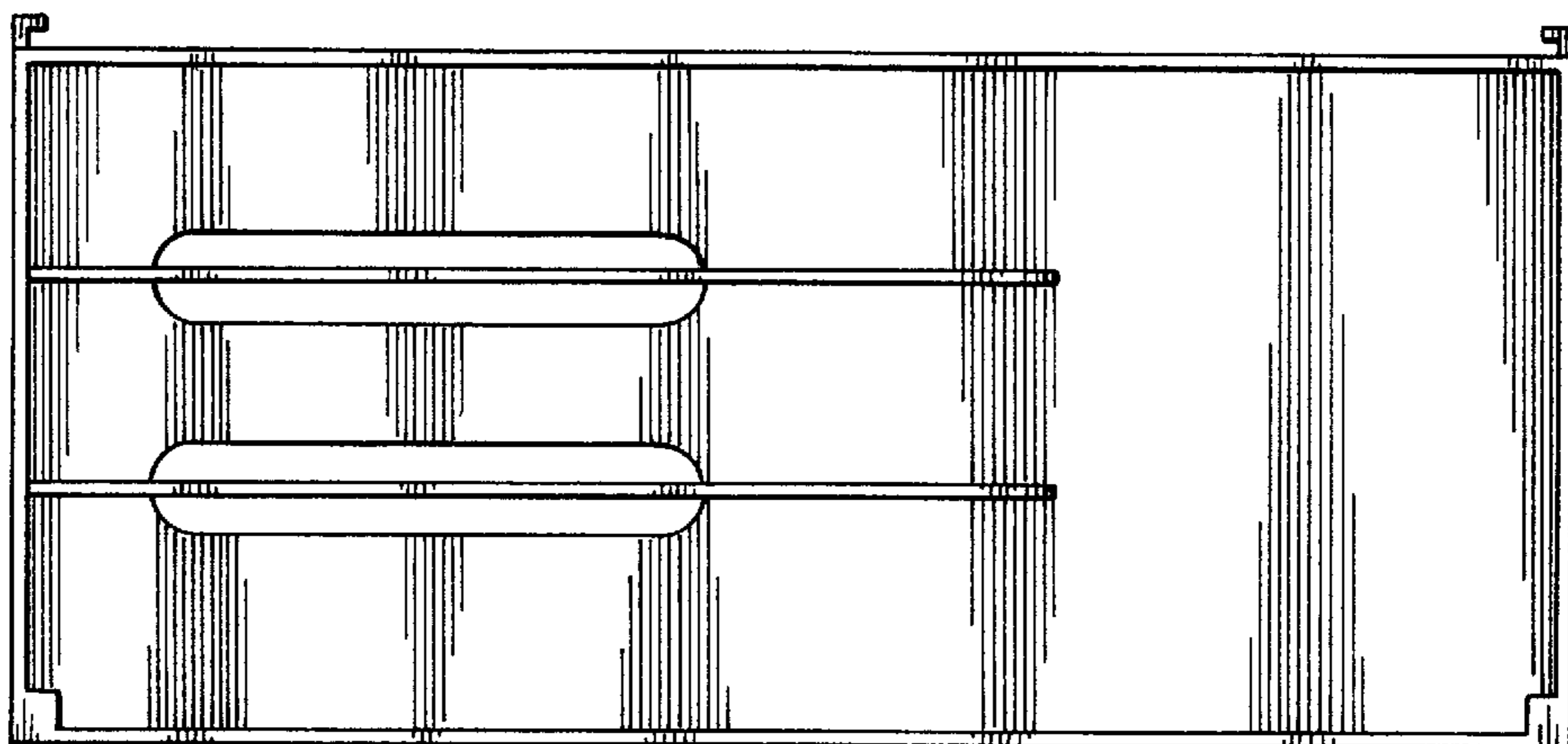

Fig. 2

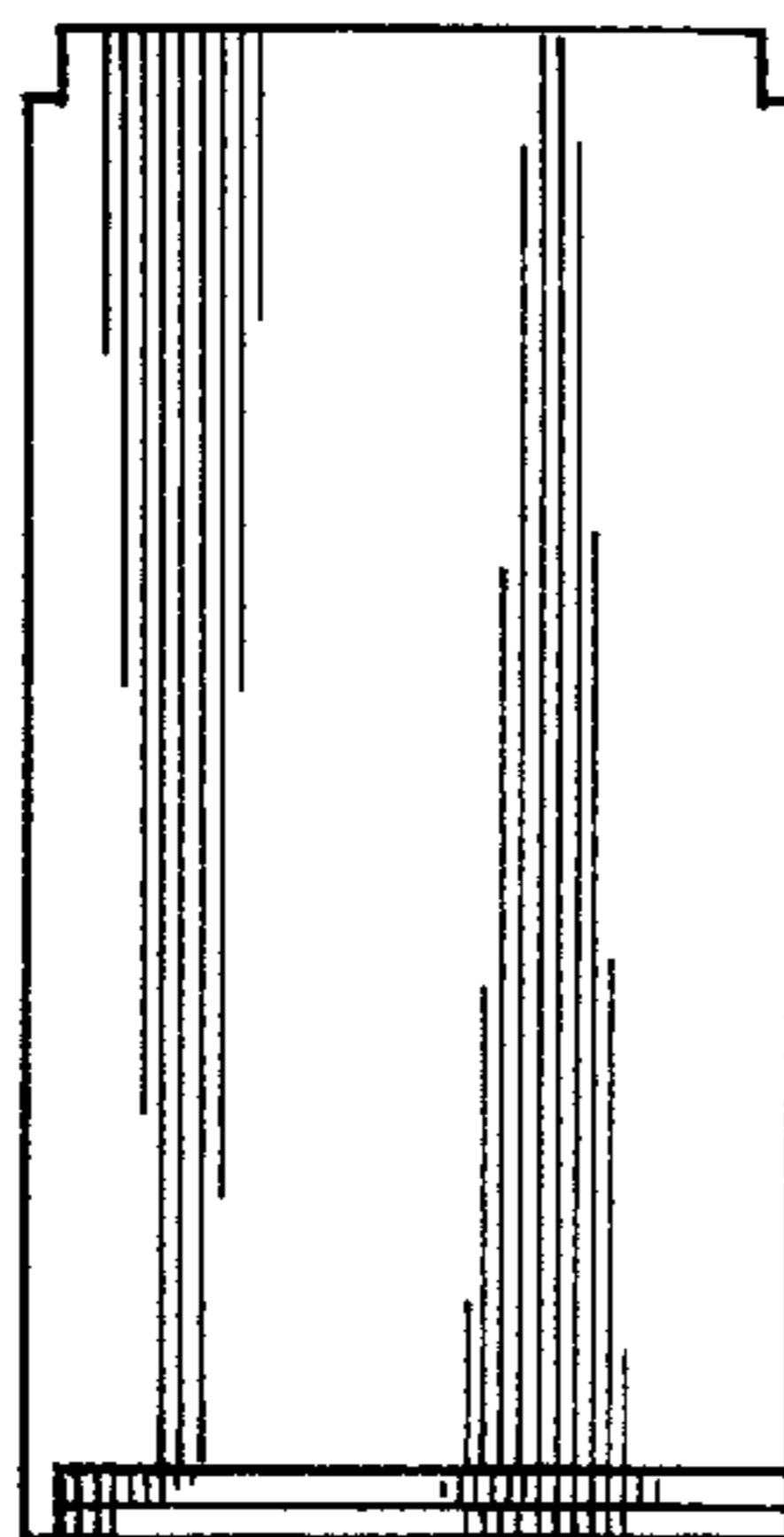

Fig. 3

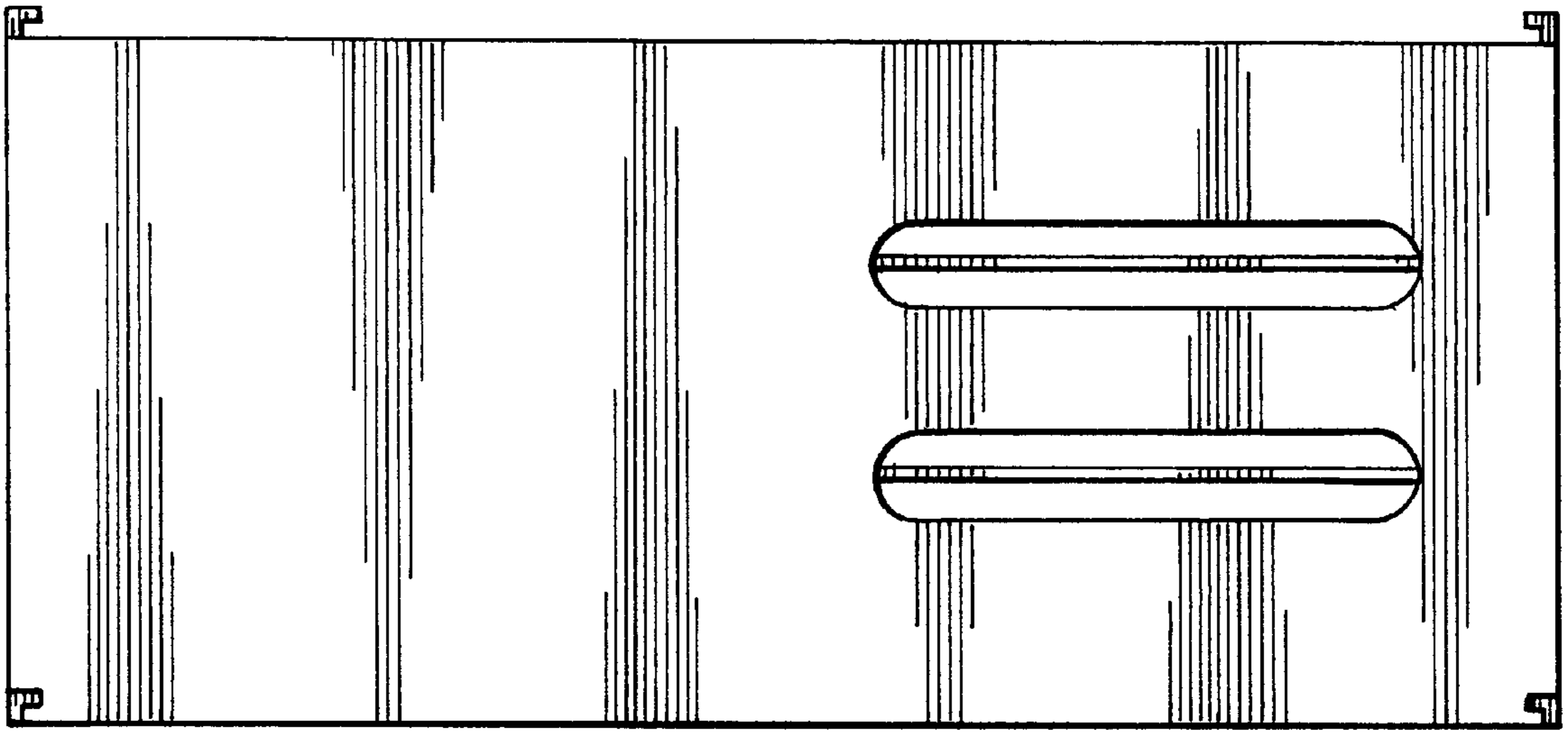

Fig. 4

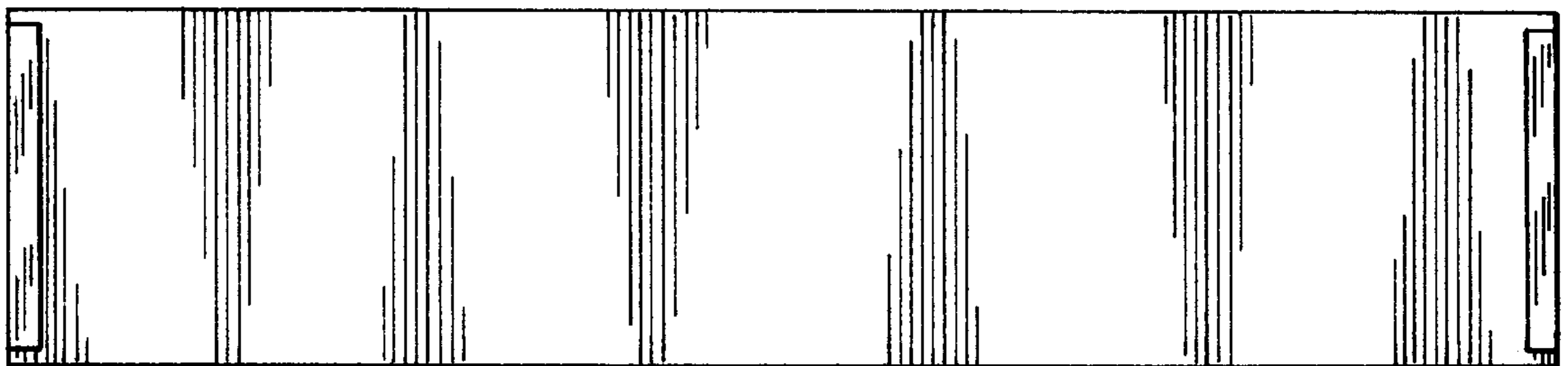

Fig. 5

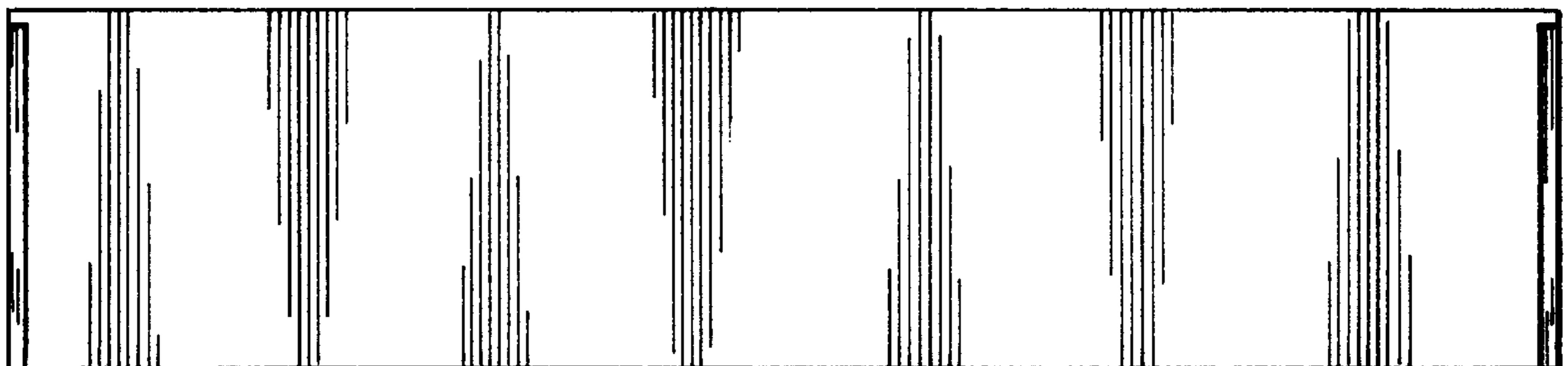

Fig. 6