



US00D442640S

(12) **United States Design Patent**
Hayashi

(10) **Patent No.:** **US D442,640 S**

(45) **Date of Patent:** **** May 22, 2001**

(54) **GAME MACHINE**

(75) Inventor: **Ryoji Hayashi**, Kanagawa-ken (JP)

(73) Assignee: **Konami Co., Ltd.**, Hyogo-ken (JP)

(**) Term: **14 Years**

(21) Appl. No.: **29/112,998**

(22) Filed: **Oct. 27, 1999**

Related U.S. Application Data

(62) Division of application No. 29/083,266, filed on Feb. 6, 1998.

(30) **Foreign Application Priority Data**

Aug. 8, 1997	(JP)	9-64462
Aug. 8, 1997	(JP)	9-64463
Aug. 8, 1997	(JP)	9-64464
Aug. 8, 1997	(JP)	9-64465
Aug. 8, 1997	(JP)	9-64466
Aug. 8, 1997	(JP)	9-64467

(51) **LOC (7) Cl.** **21-01**

(52) **U.S. Cl.** **D21/305**

(58) **Field of Search** D21/324-327;
273/148 B, 454, 455, 456, 460, 461, 440;
463/1, 2, 5, 13, 46, 47, 49-57

(56) **References Cited**

U.S. PATENT DOCUMENTS

D. 293,120	*	12/1987	De Prins	D21/325
D. 297,655	*	9/1988	Daugherty	D21/325
D. 325,420	*	4/1992	Mirando et al.	D21/325
D. 327,508	*	6/1992	Mirando et al.	D21/325
4,643,421	*	2/1987	Meyer et al.	463/1
5,411,257	*	5/1995	Fulton	463/13
5,591,081	*	1/1997	Suzuki	463/17
5,820,460	*	10/1998	Fulton	463/26 X
5,855,374	*	1/1999	Shoemaker, Jr.	273/447

FOREIGN PATENT DOCUMENTS

769209	9/1989	(JP)	.
864642	3/1993	(JP)	.

OTHER PUBLICATIONS

P. 88 of the monthly magazine "Game Machine in Taiwan" published Jul. 1997.

The cover of the monthly magazine Game Machine in Taiwan published Jul. 1997.

* cited by examiner

Primary Examiner—Prabhakar Deshmukh

(74) *Attorney, Agent, or Firm*—Jordan and Hamburg LLP

(57) **CLAIM**

The ornamental design for a game machine, as shown and described.

DESCRIPTION

FIG. 1 is a front elevational view of a first embodiment of a game machine showing my new design;

FIG. 2 is a rear elevational view of the first embodiment;

FIG. 3 is a top plan view of the first embodiment;

FIG. 4 is a bottom plan view of the first embodiment;

FIG. 5 is a left side elevational view of the first embodiment;

FIG. 6 is a right side elevational view of the first embodiment;

FIG. 7 is a sectional view of the first embodiment taken along line 7—7 of FIG. 1;

FIG. 8 is a perspective view of the first embodiment;

FIG. 9 is a front elevational view of a second embodiment;

FIG. 10 is a rear elevational view of the second embodiment;

FIG. 11 is a top plan view of the second embodiment;

FIG. 12 is a bottom plan view of the second embodiment;

FIG. 13 is a left side elevational view of the second embodiment;

FIG. 14 is a right side elevational view of the second embodiment;

FIG. 15 is a sectional view of the second embodiment taken along line 15—15 of FIG. 9;

FIG. 16 is a perspective view of the second embodiment;

FIG. 17 is a front elevational view of a third embodiment;

FIG. 18 is a rear elevational view of the third embodiment;

FIG. 19 is a top plan view of the third embodiment;

FIG. 20 is a bottom plan view of the third embodiment;

FIG. 21 is a left side elevational view of the third embodiment;

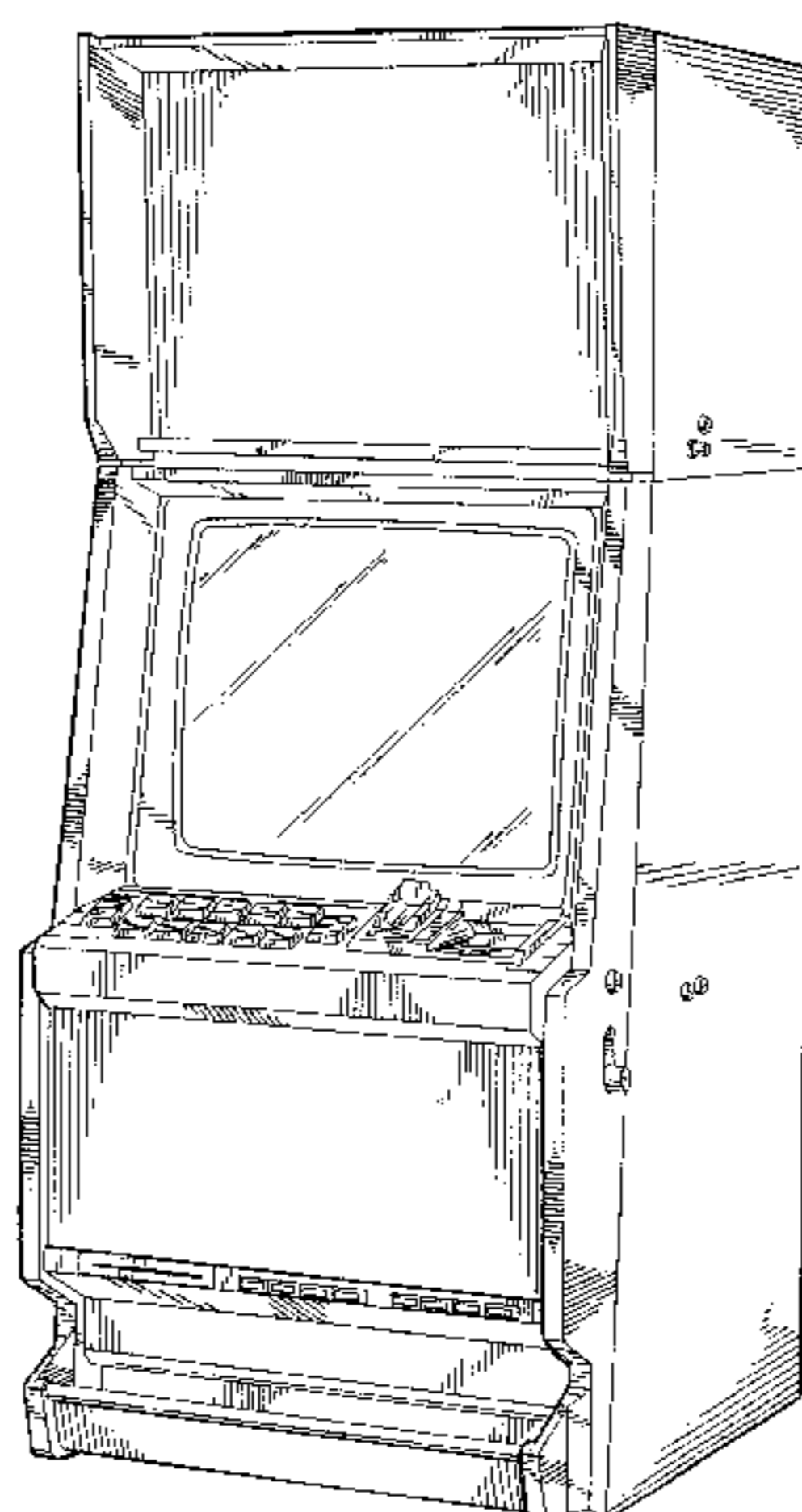

FIG. 22 is a right side elevational view of the third embodiment;

FIG. 23 is a sectional view of the third embodiment taken along line 23—23 of FIG. 17;

FIG. 24 is a perspective view of the third embodiment;

FIG. 25 is a front elevational view of a fourth embodiment;

FIG. 26 is a rear elevational view of the fourth embodiment;

FIG. 27 is a top plan view of the fourth embodiment;

FIG. 28 is a bottom plan view of the fourth embodiment;

FIG. 29 is a left side elevational view of the fourth embodiment;

FIG. 30 is a right side elevational view of the fourth embodiment;

FIG. 31 is a sectional view of the fourth embodiment taken along line 31—31 of FIG. 25; and,

FIG. 32 is a perspective view of the fourth embodiment.

1 Claim, 32 Drawing Sheets

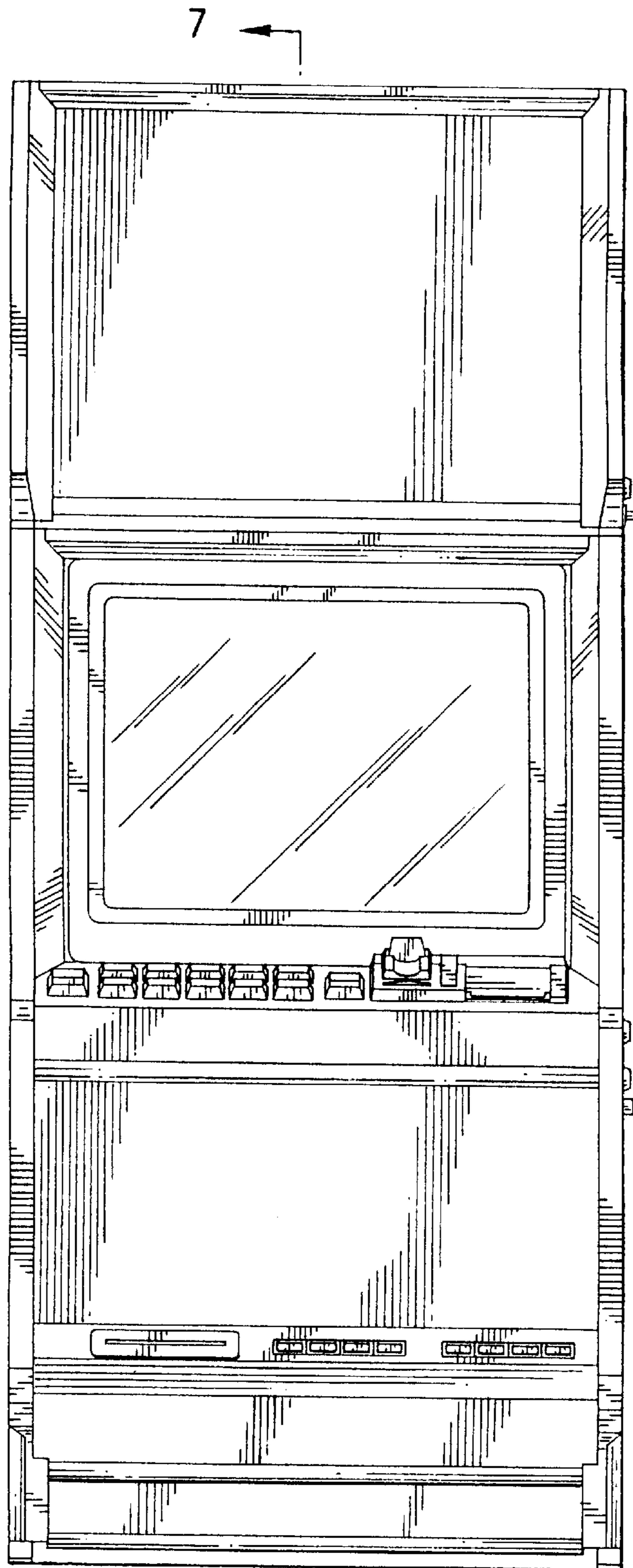

FIG. 1

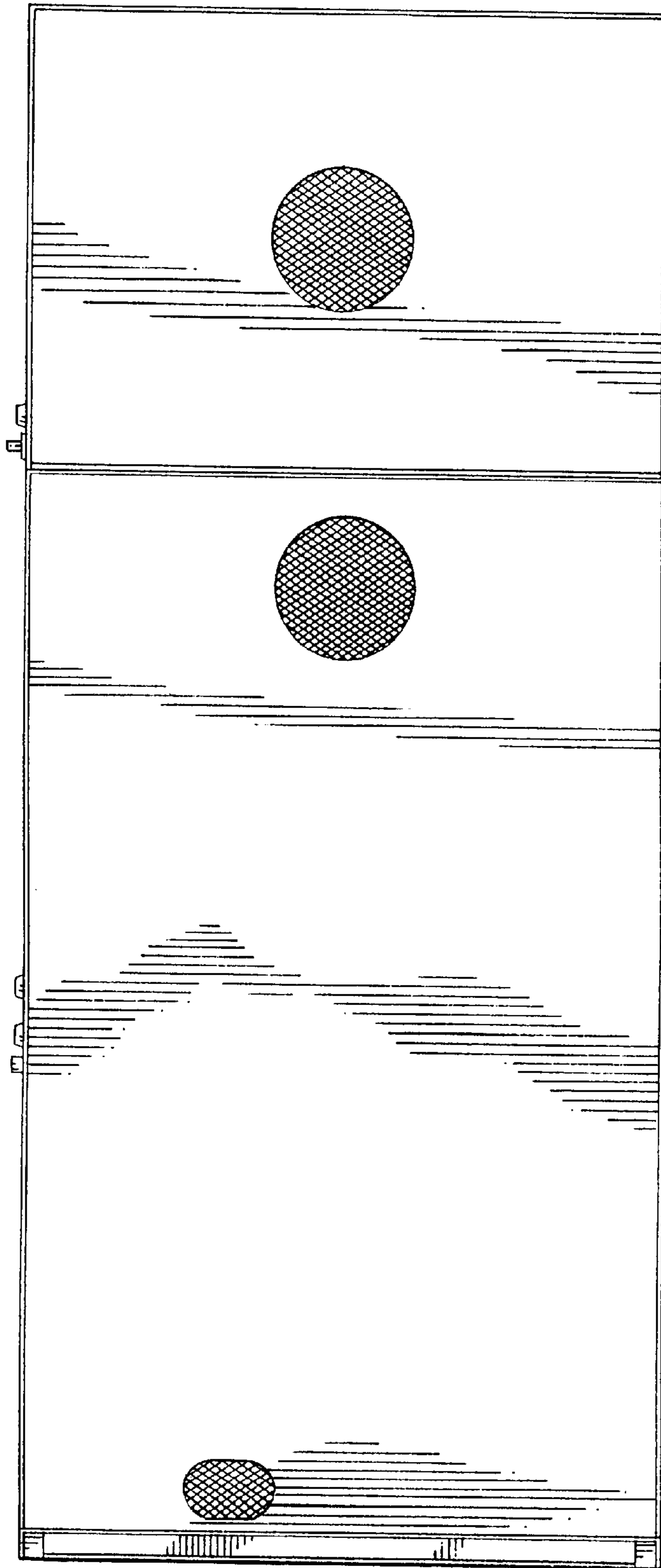

FIG.2

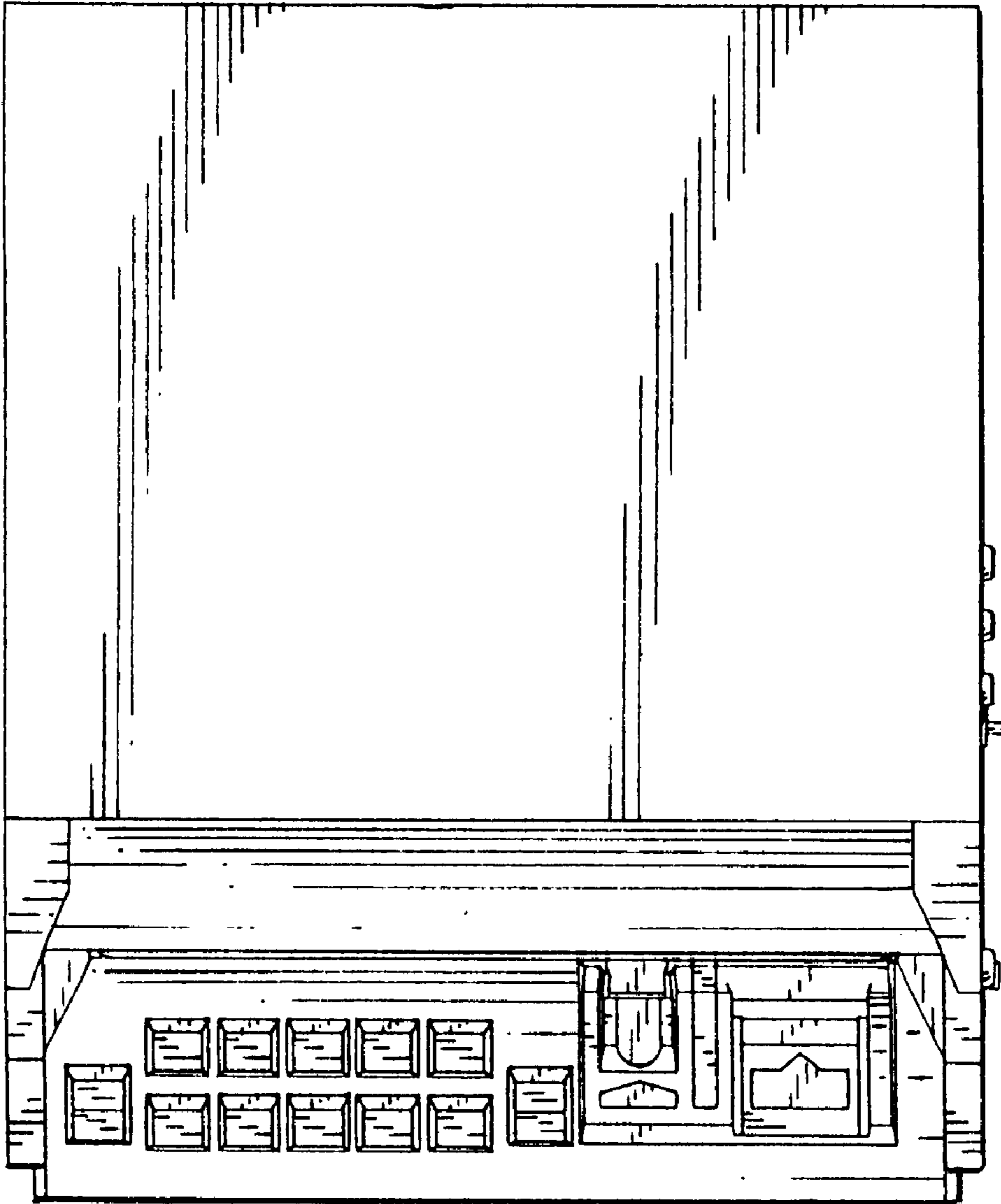

FIG.3

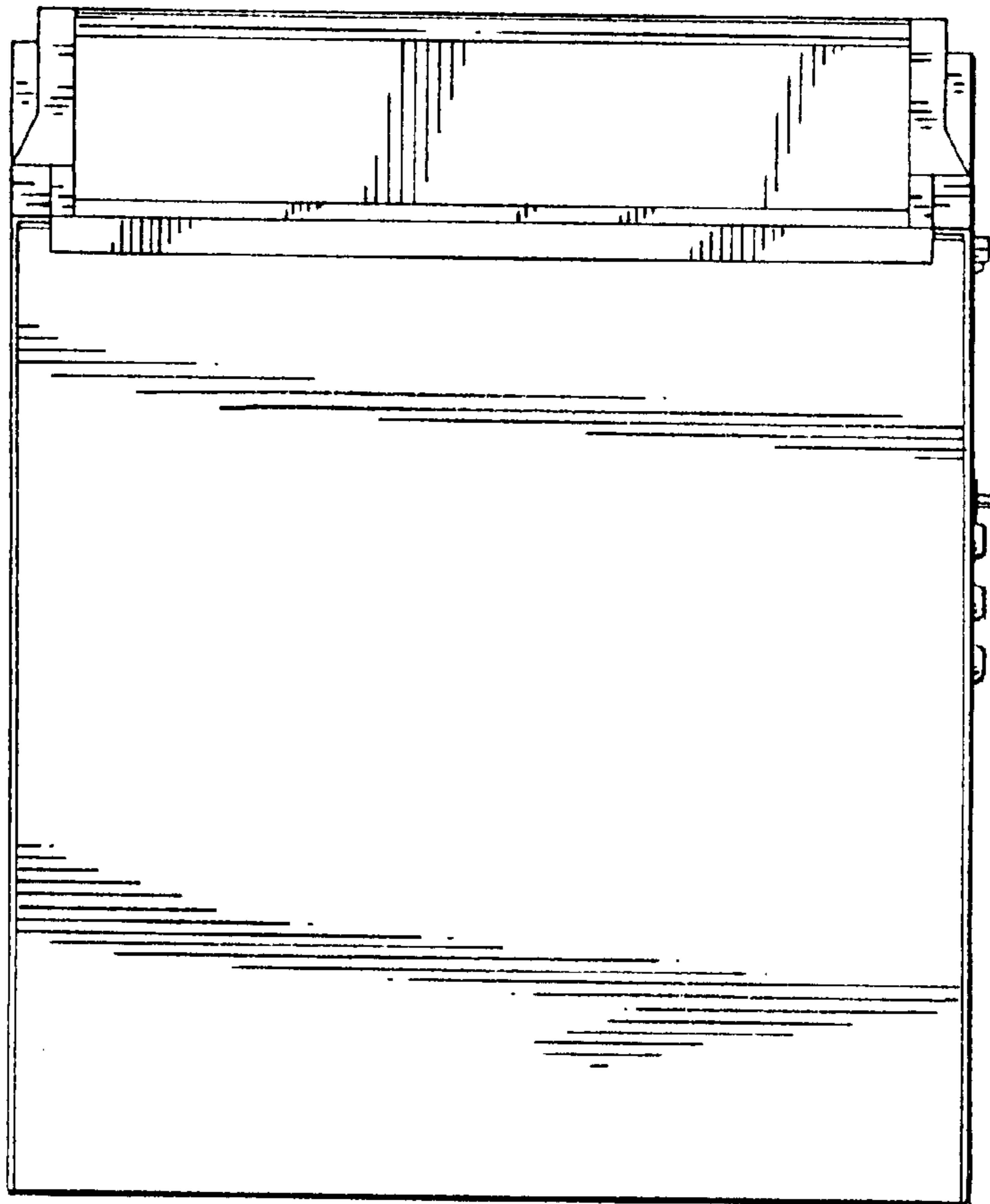

FIG. 4

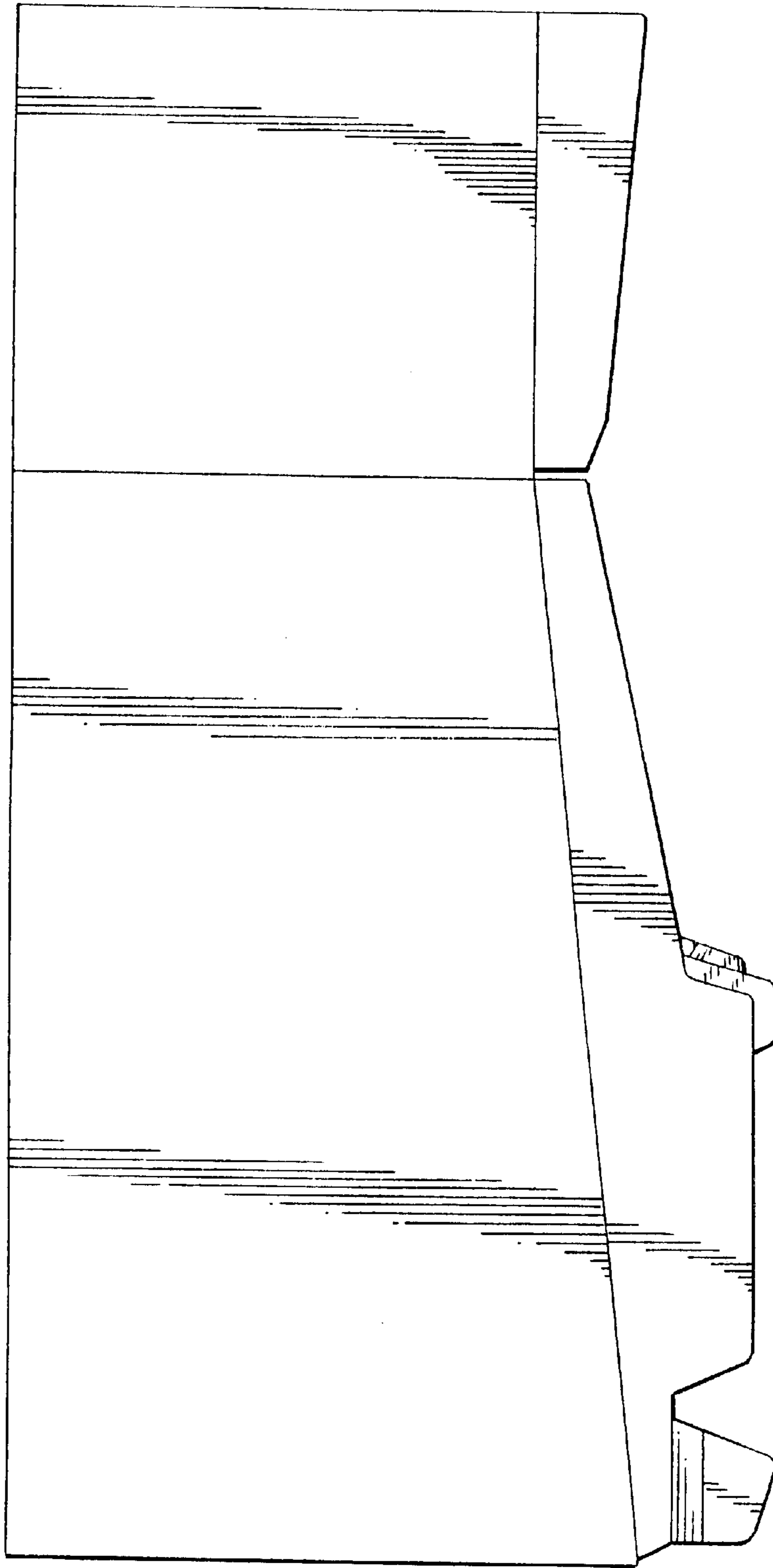

FIG.5

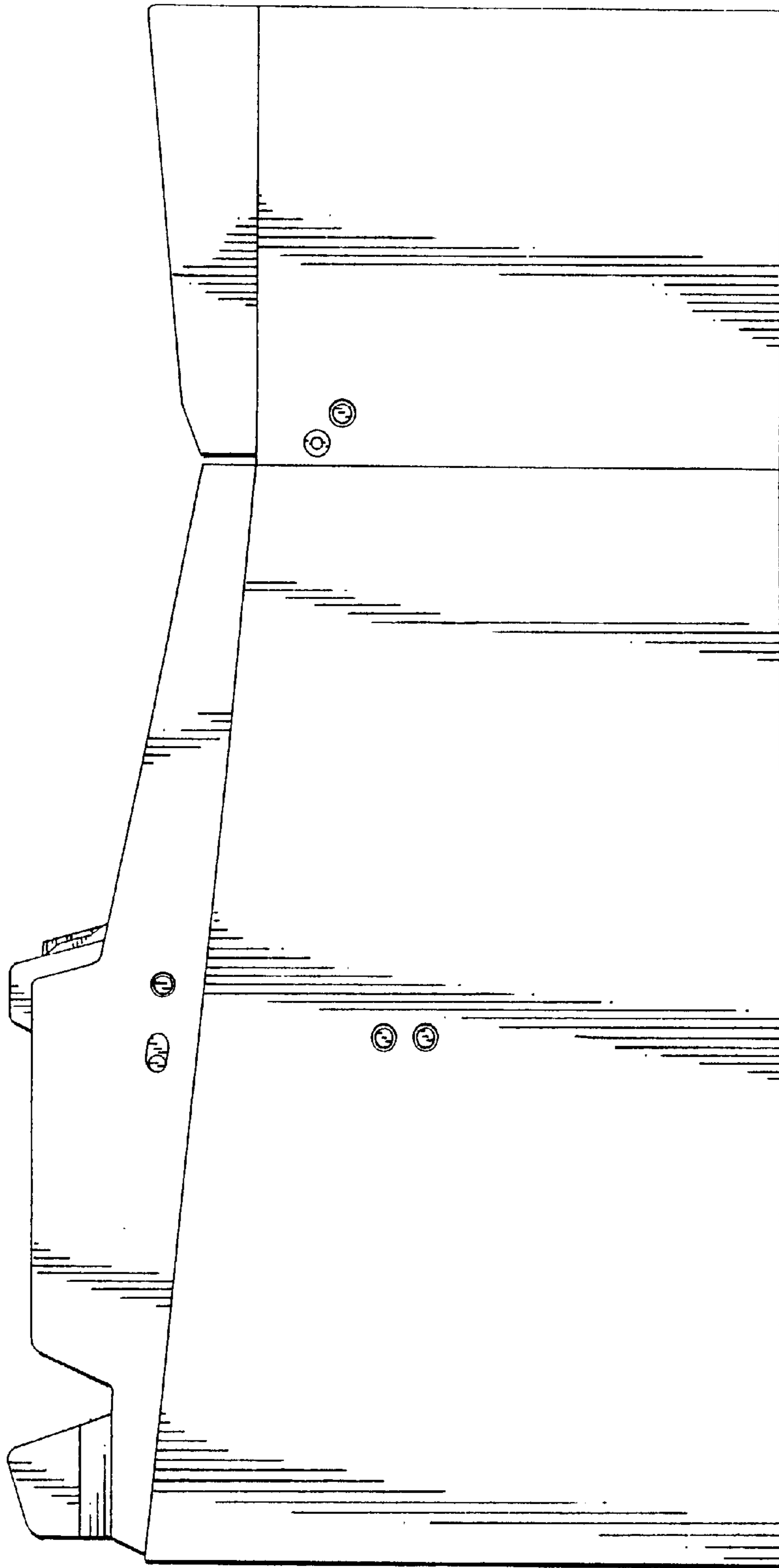

FIG. 6

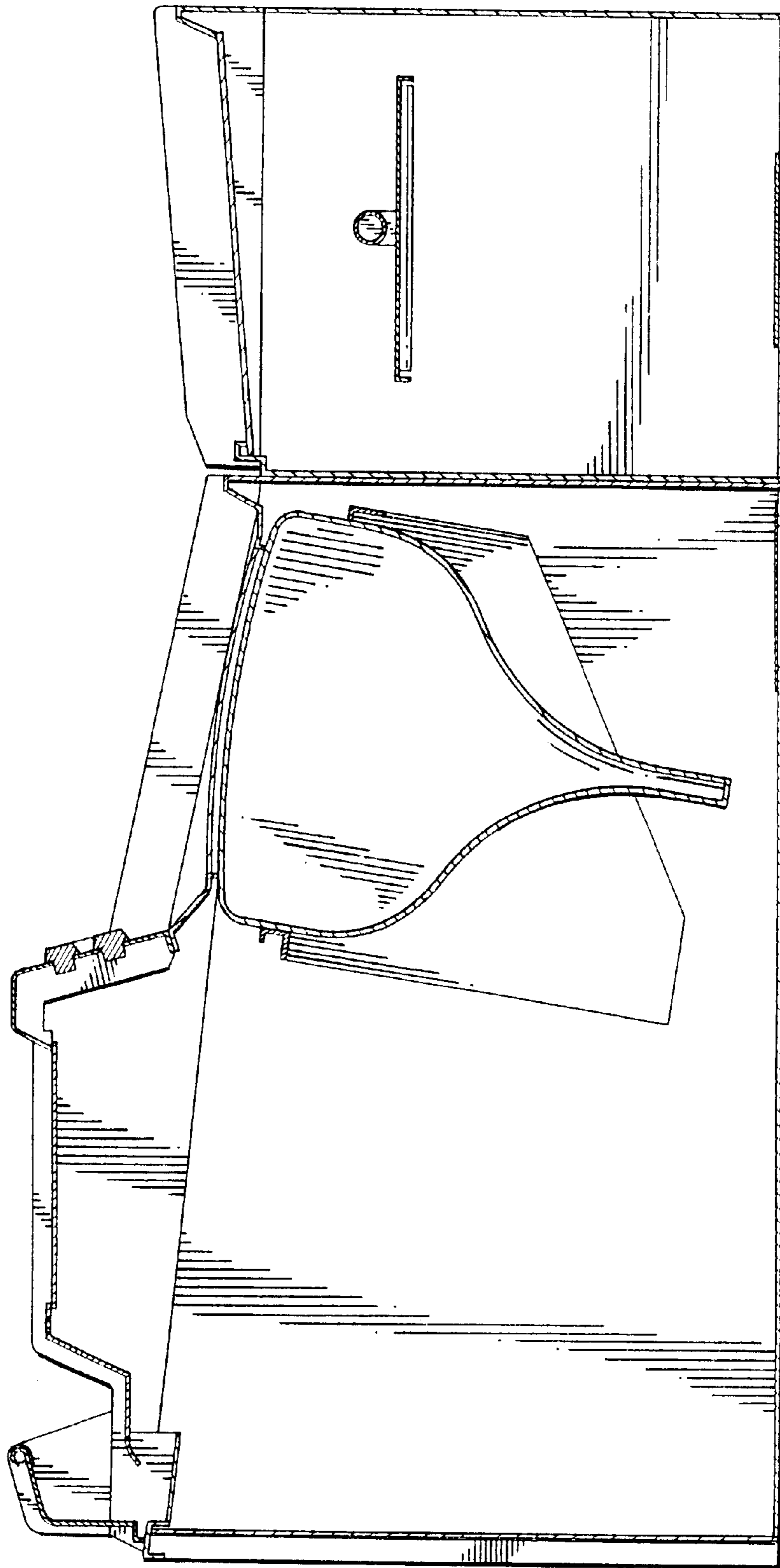

FIG.7

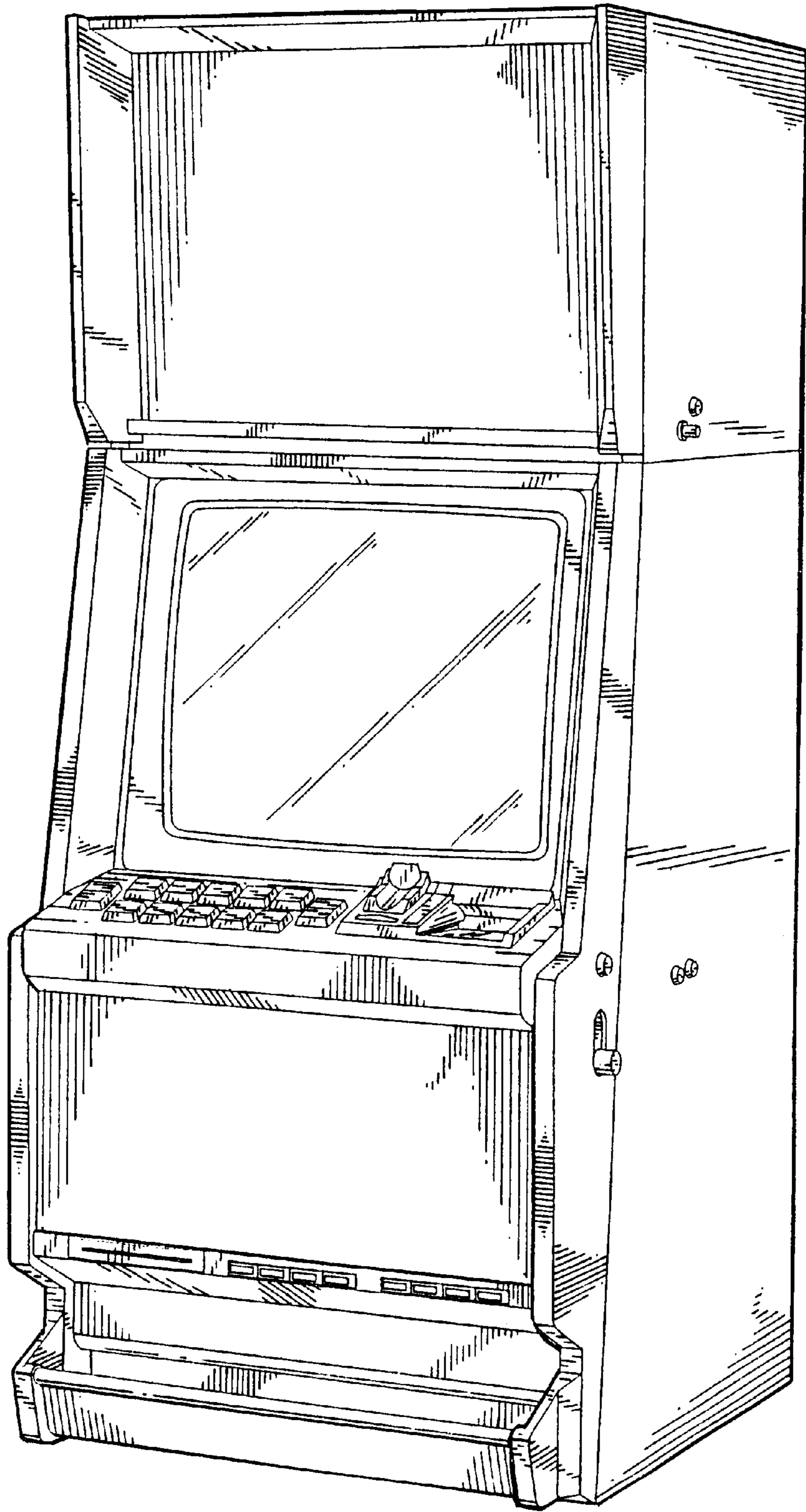
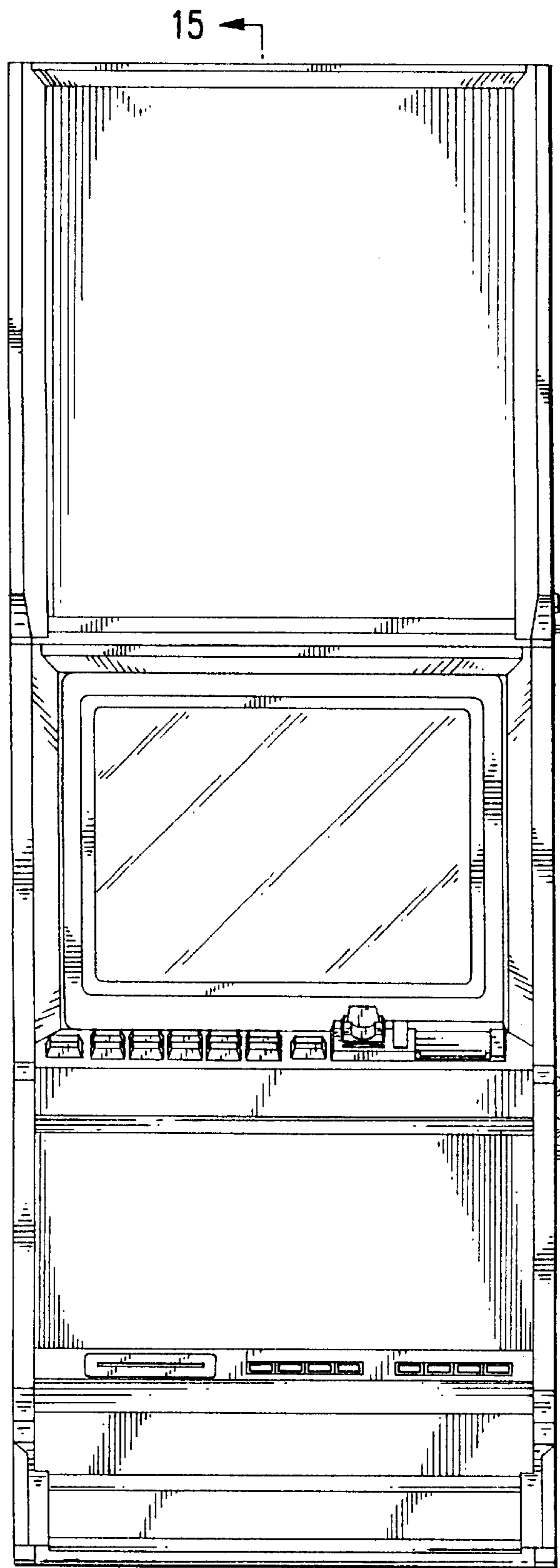

FIG.8



15 ←
FIG. 9

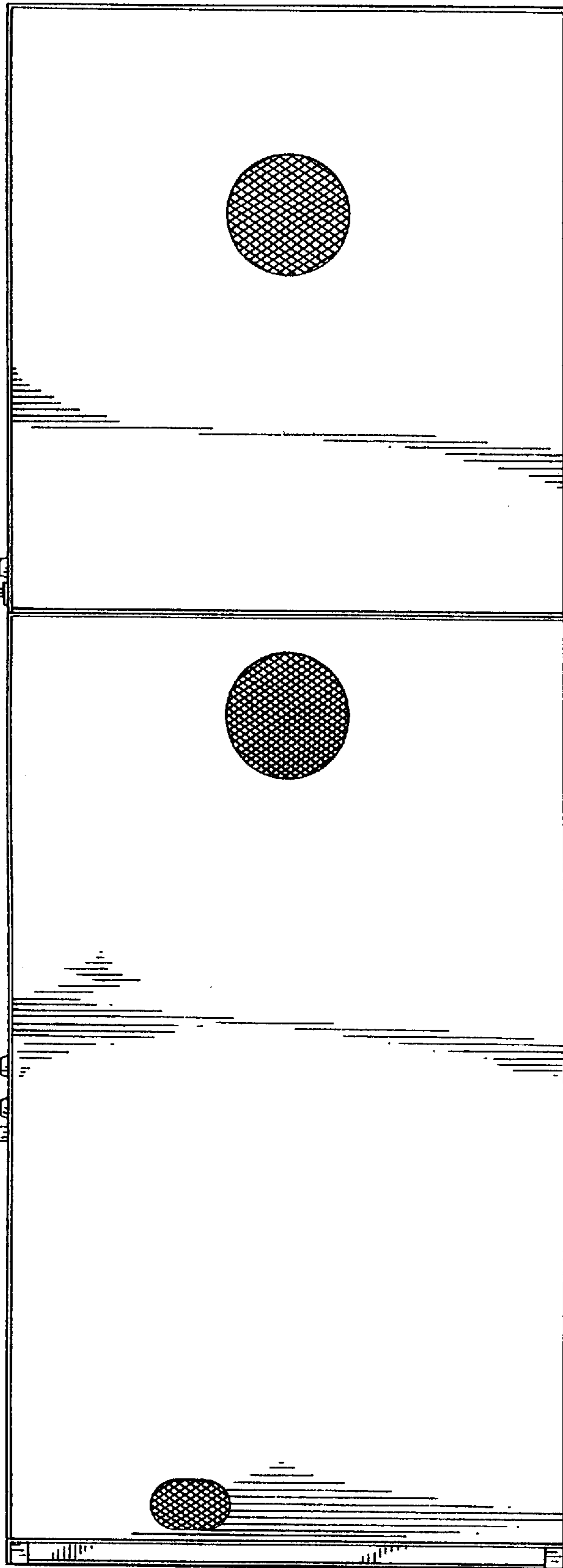

FIG.10

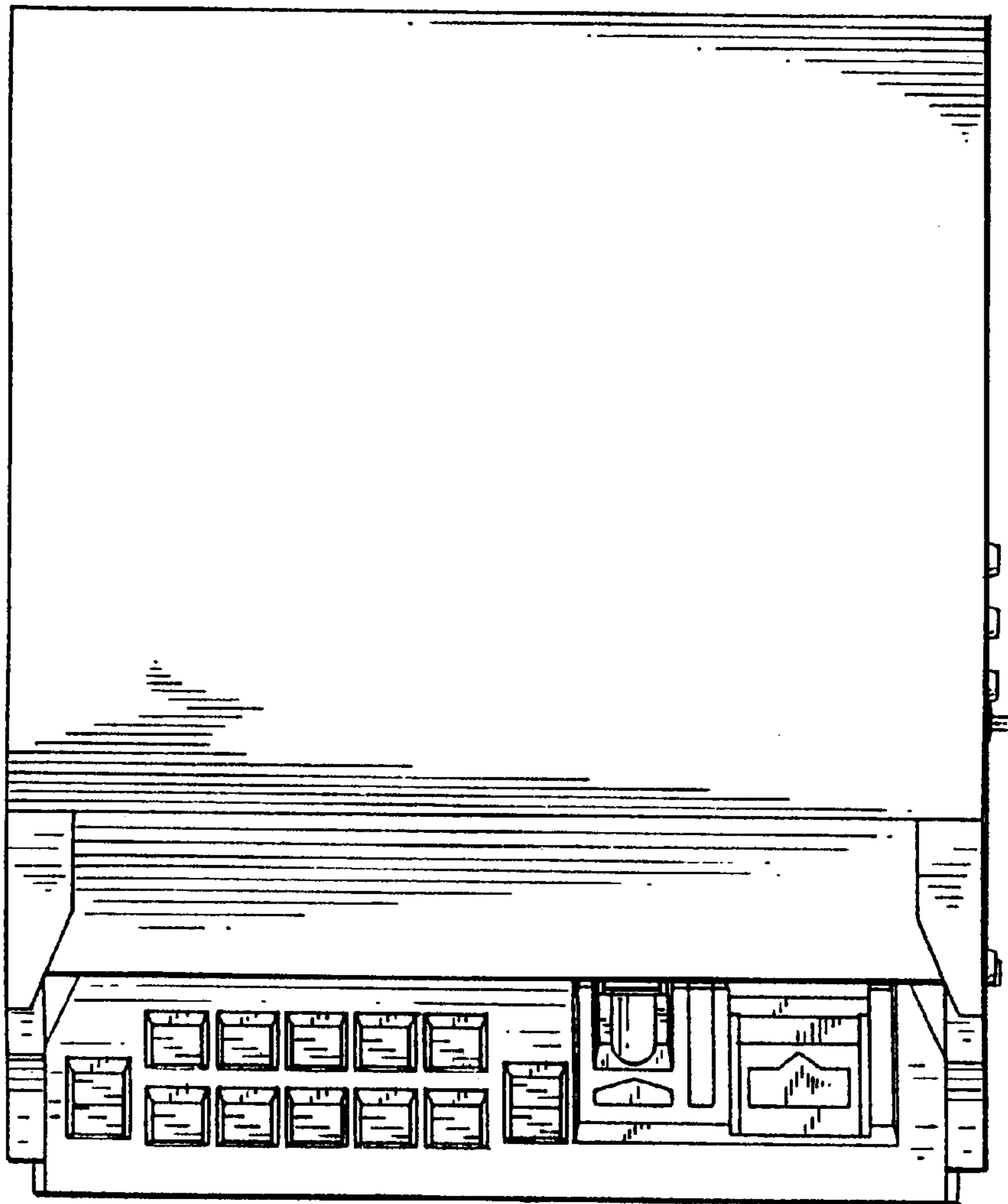

FIG. 11

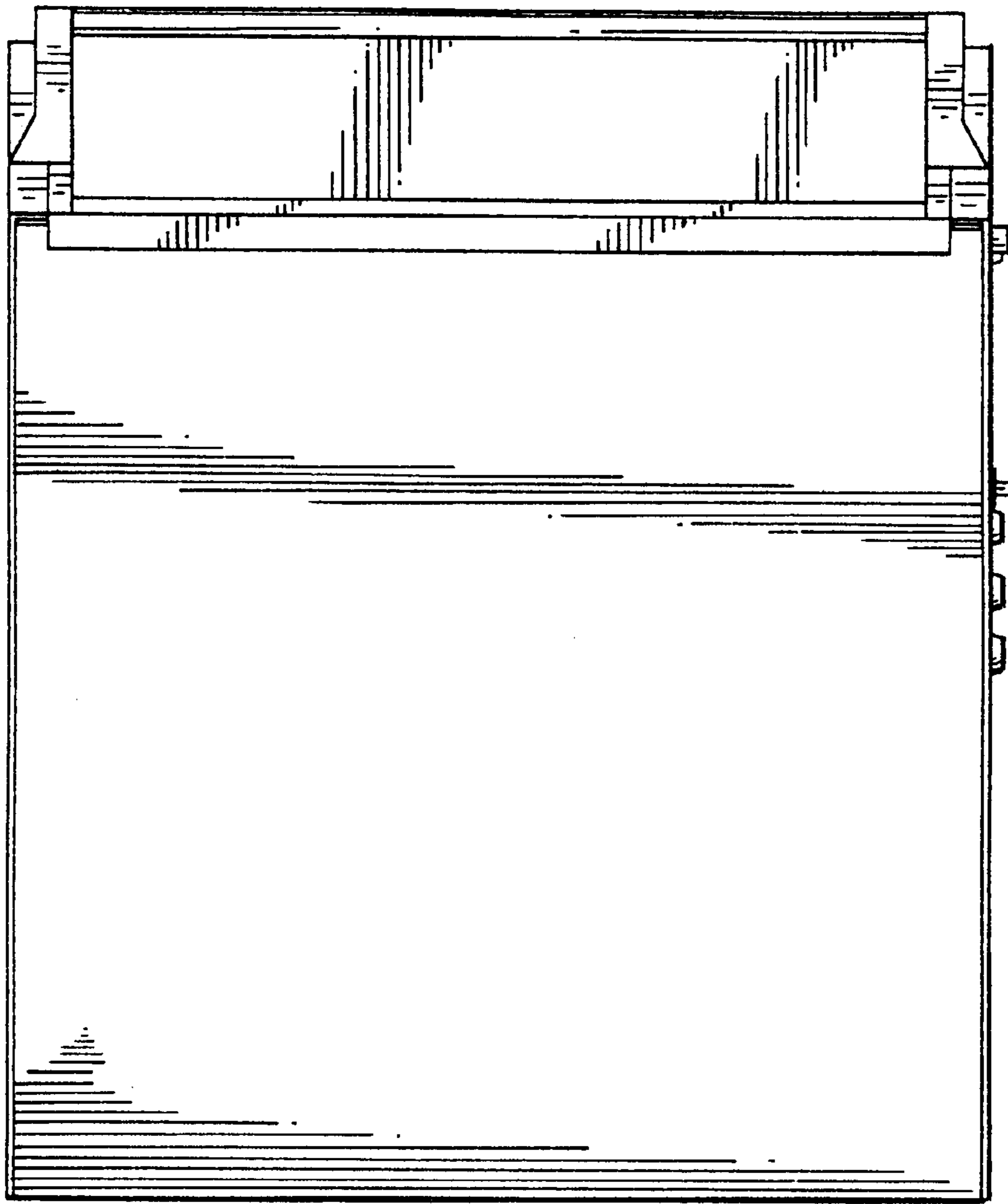

FIG. 12

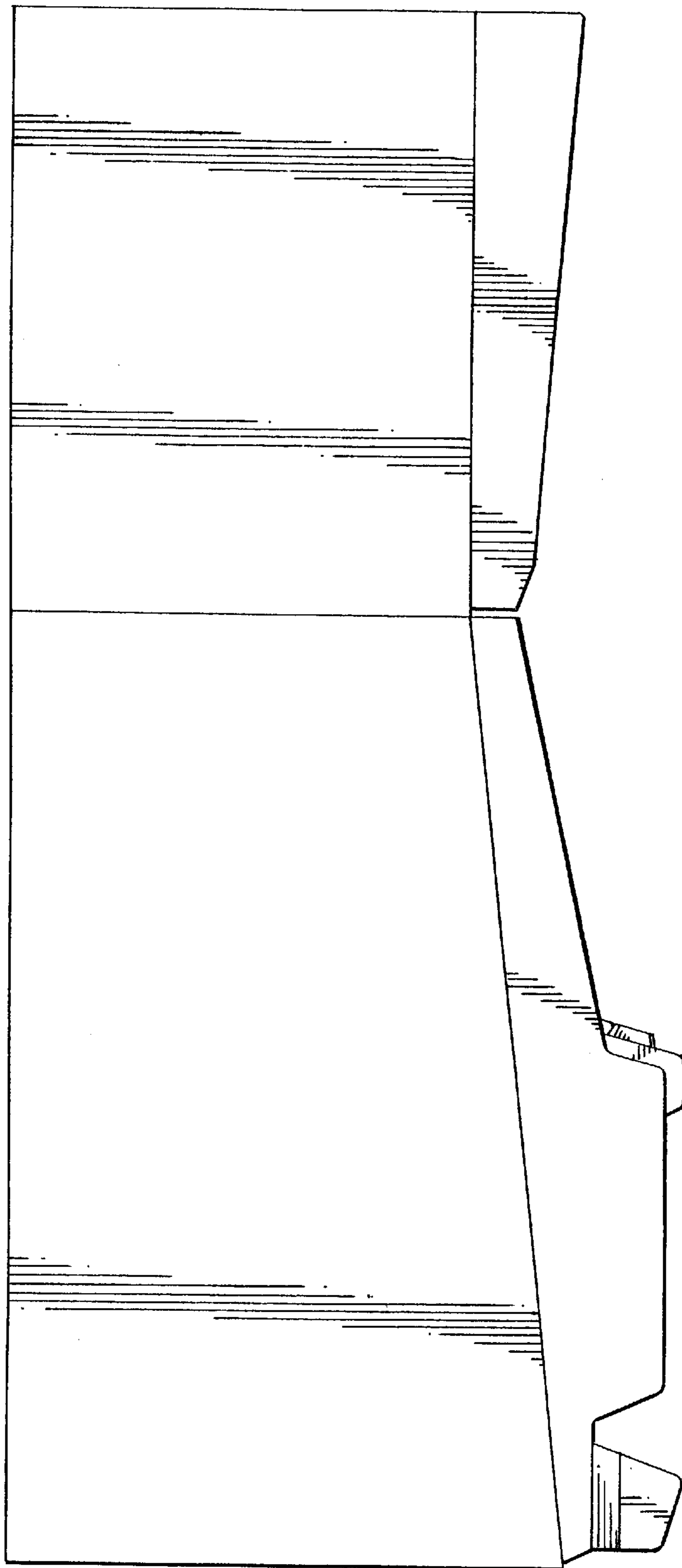

FIG. 13

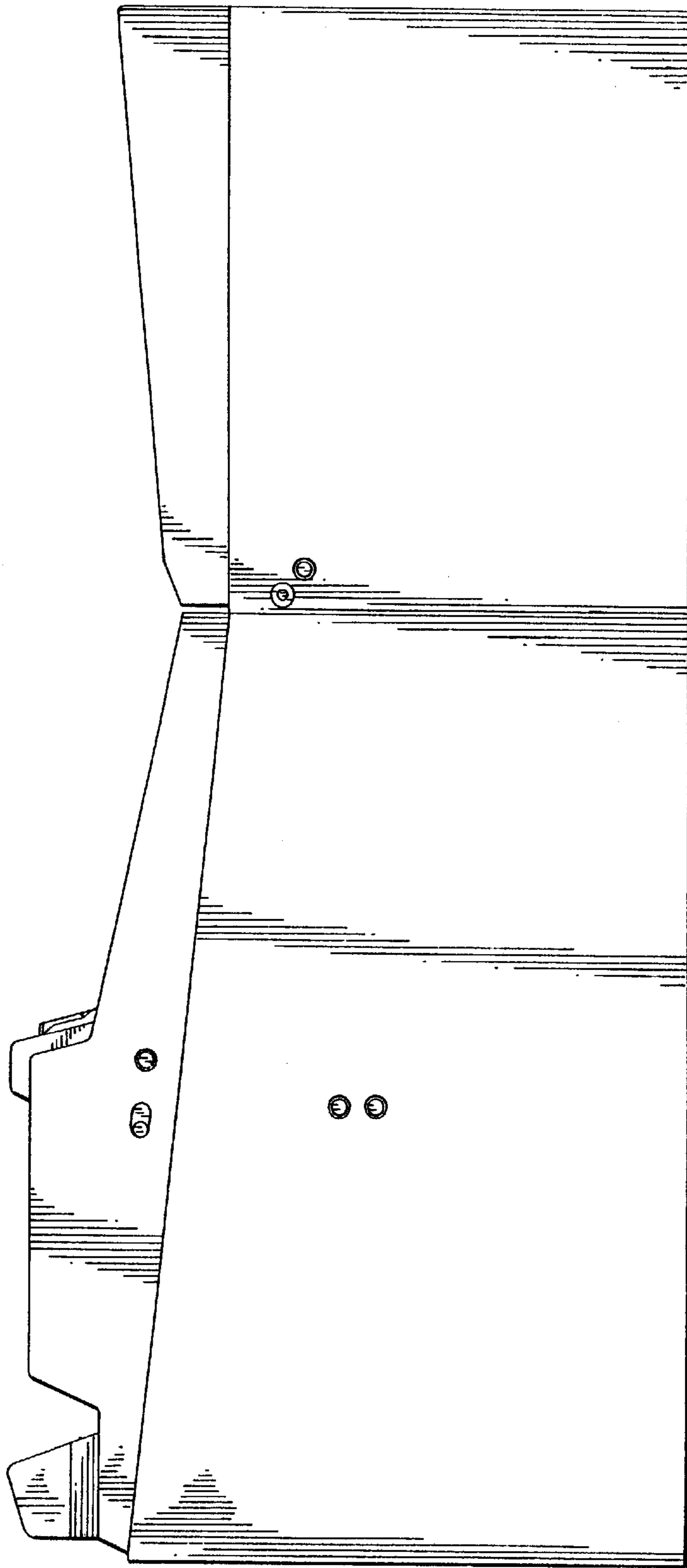

FIG. 14

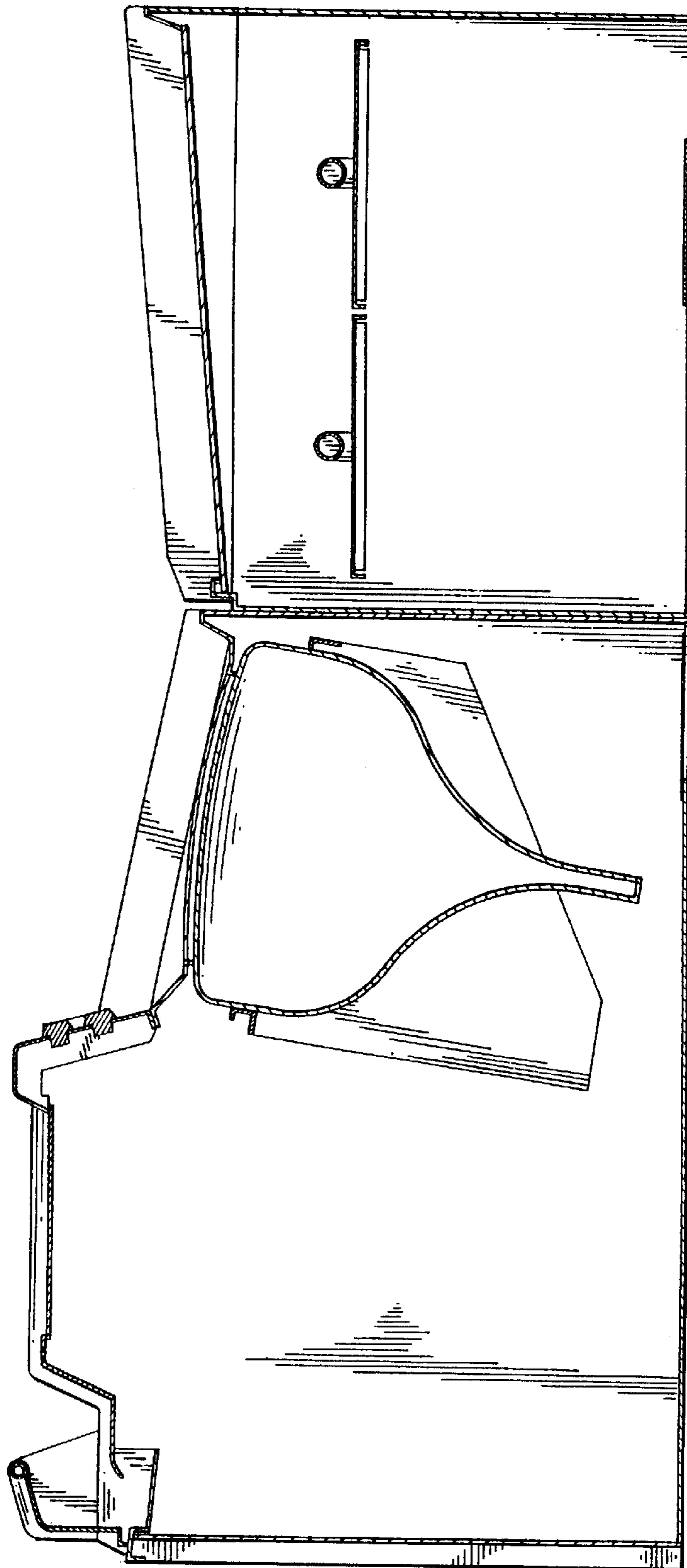

FIG. 15

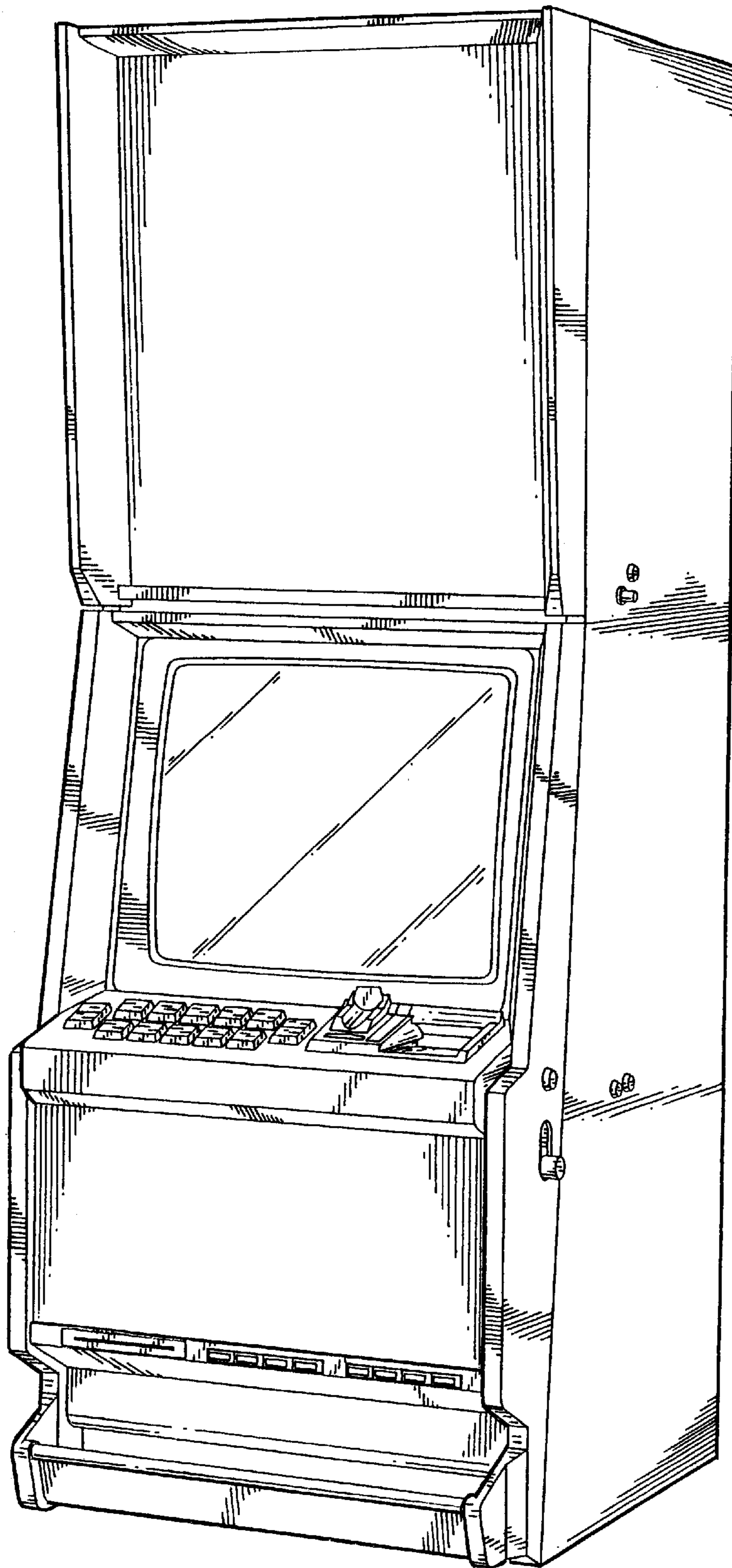
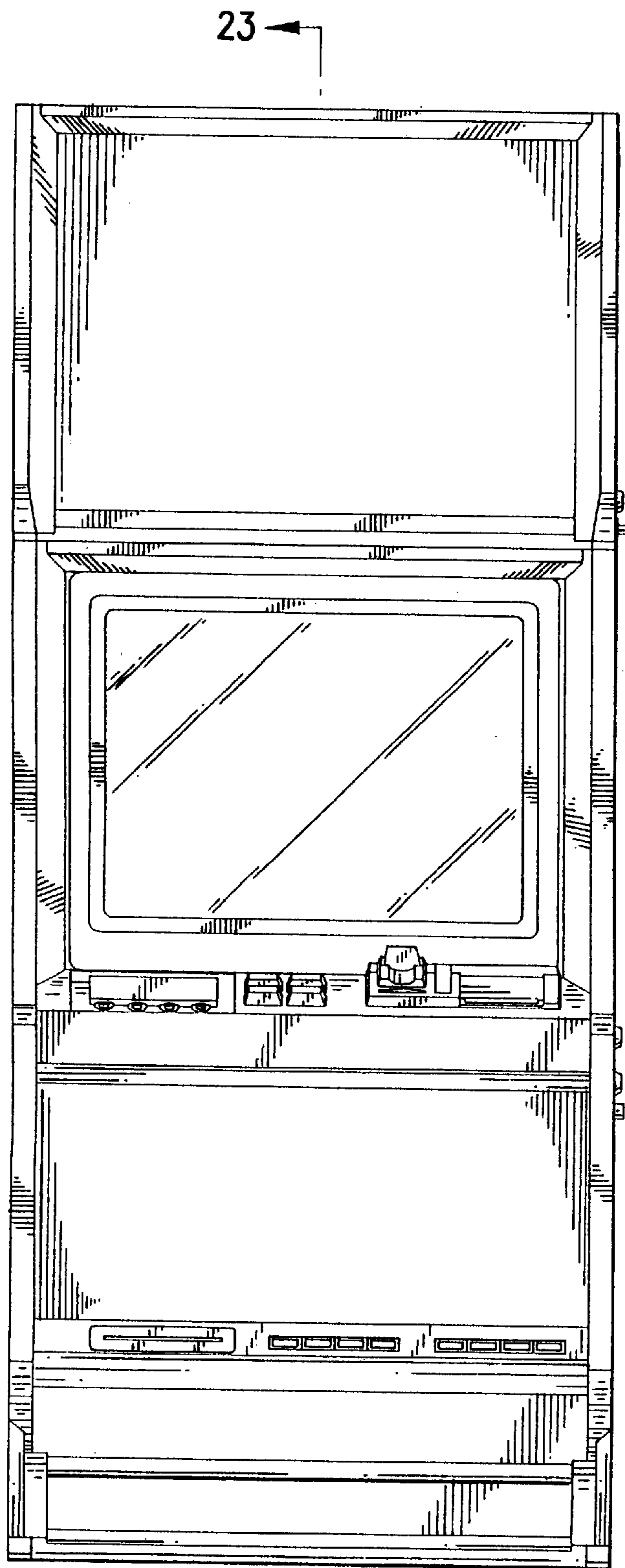

FIG. 16



23
FIG. 17

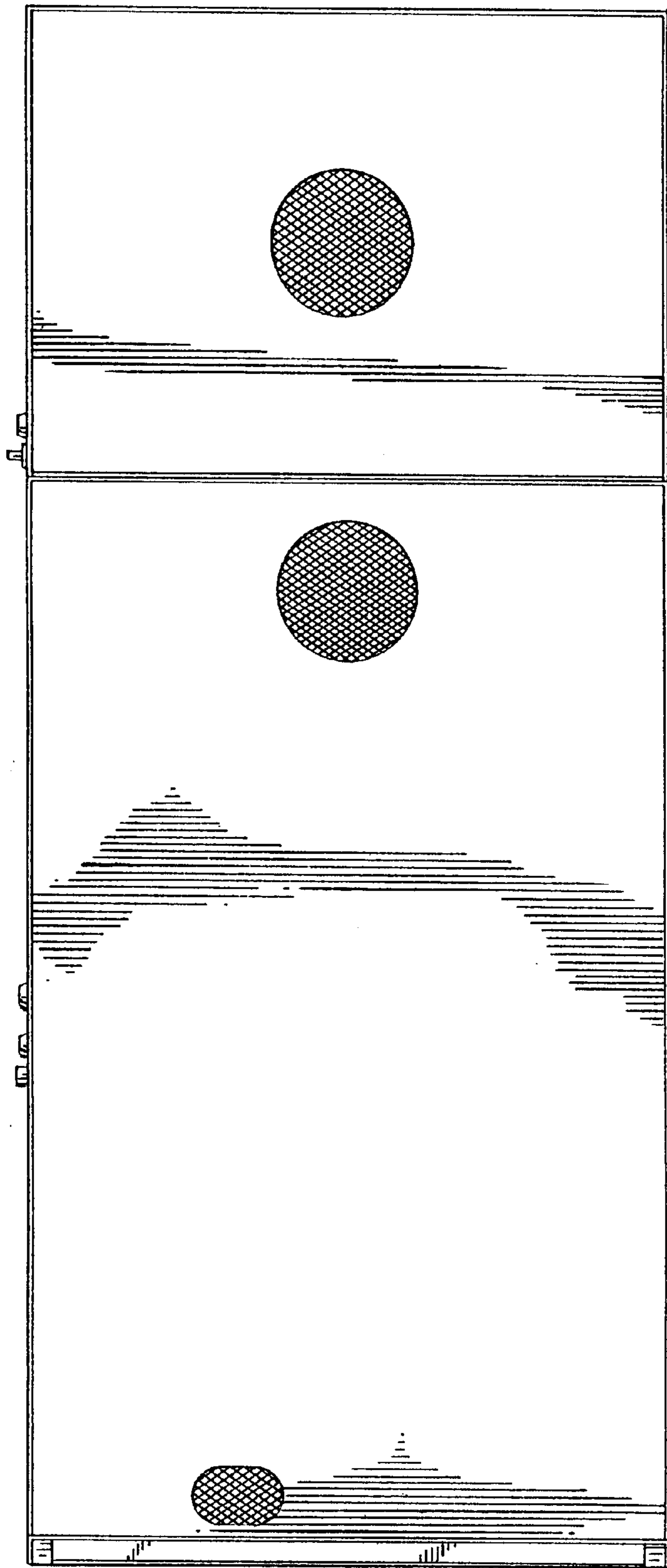

FIG. 18

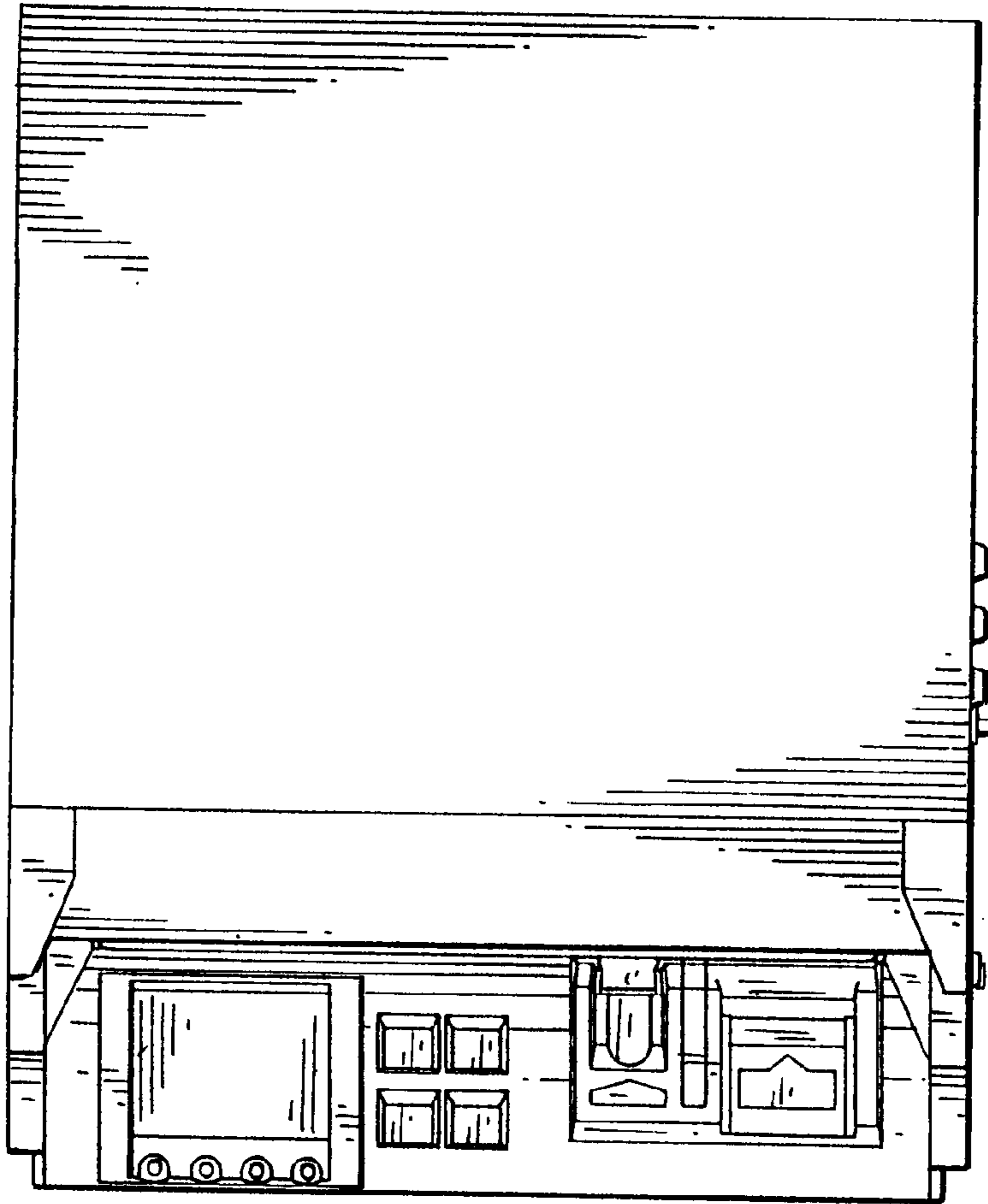

FIG. 19

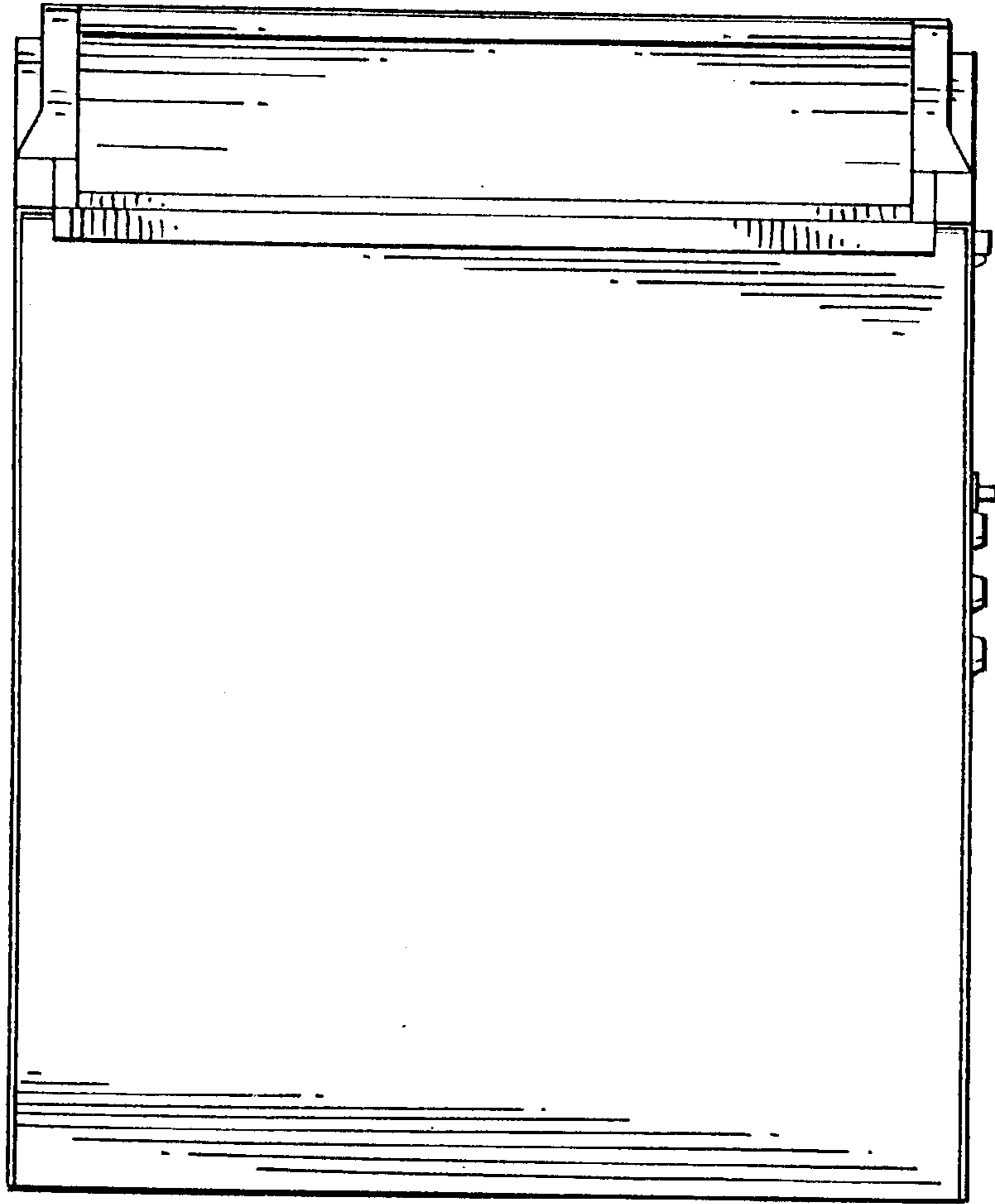

FIG. 20

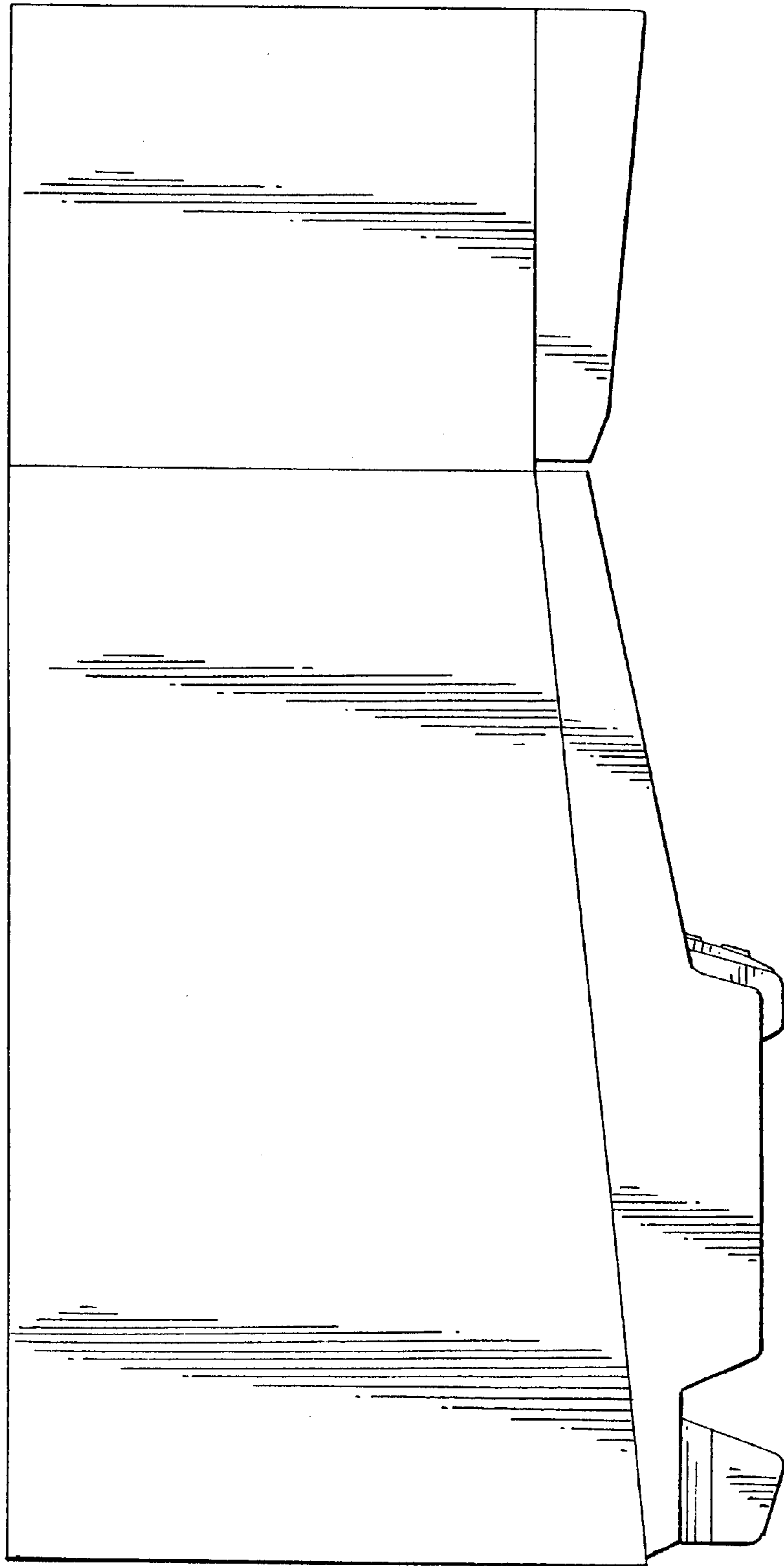

FIG. 21

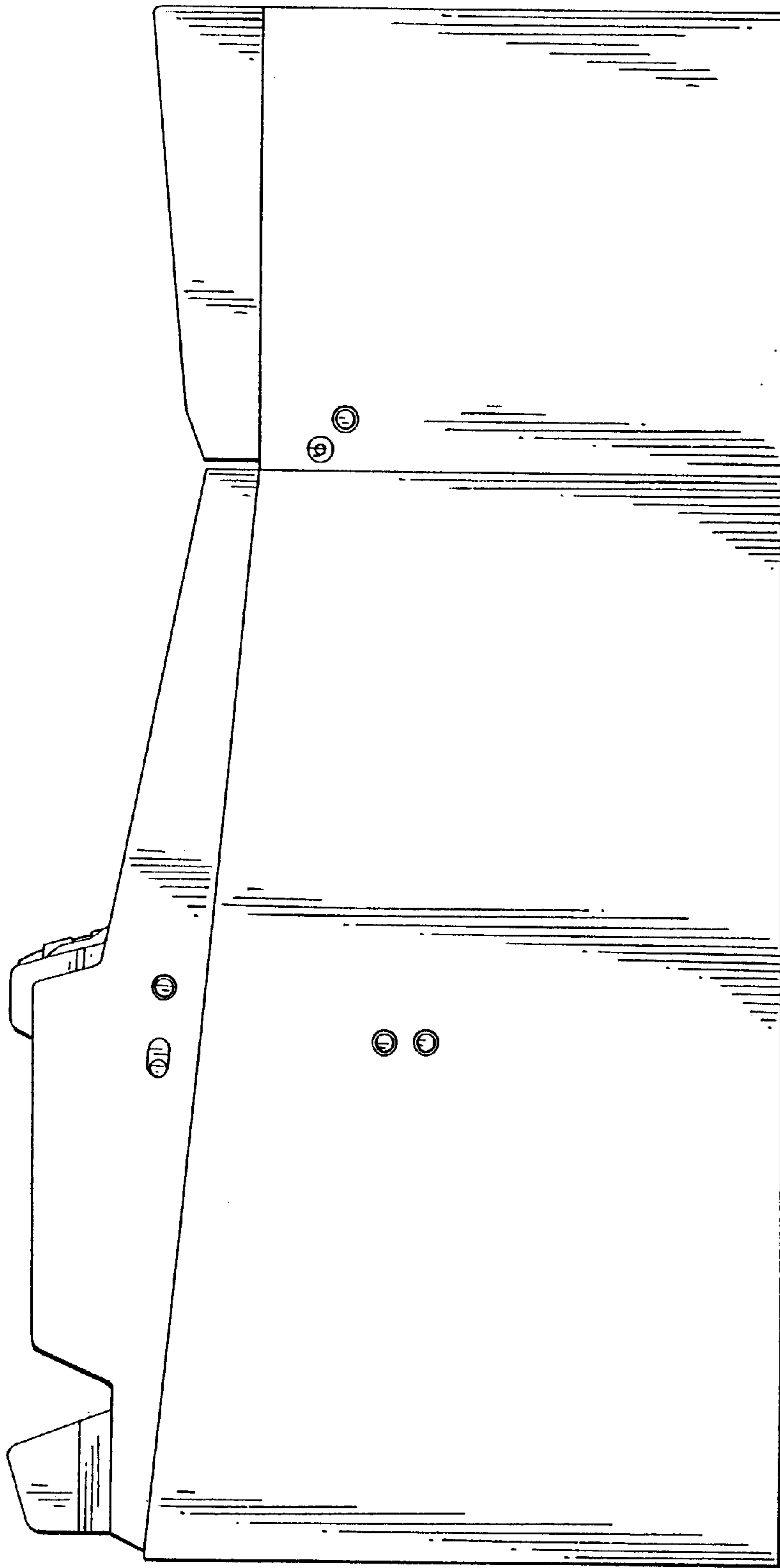

FIG. 22

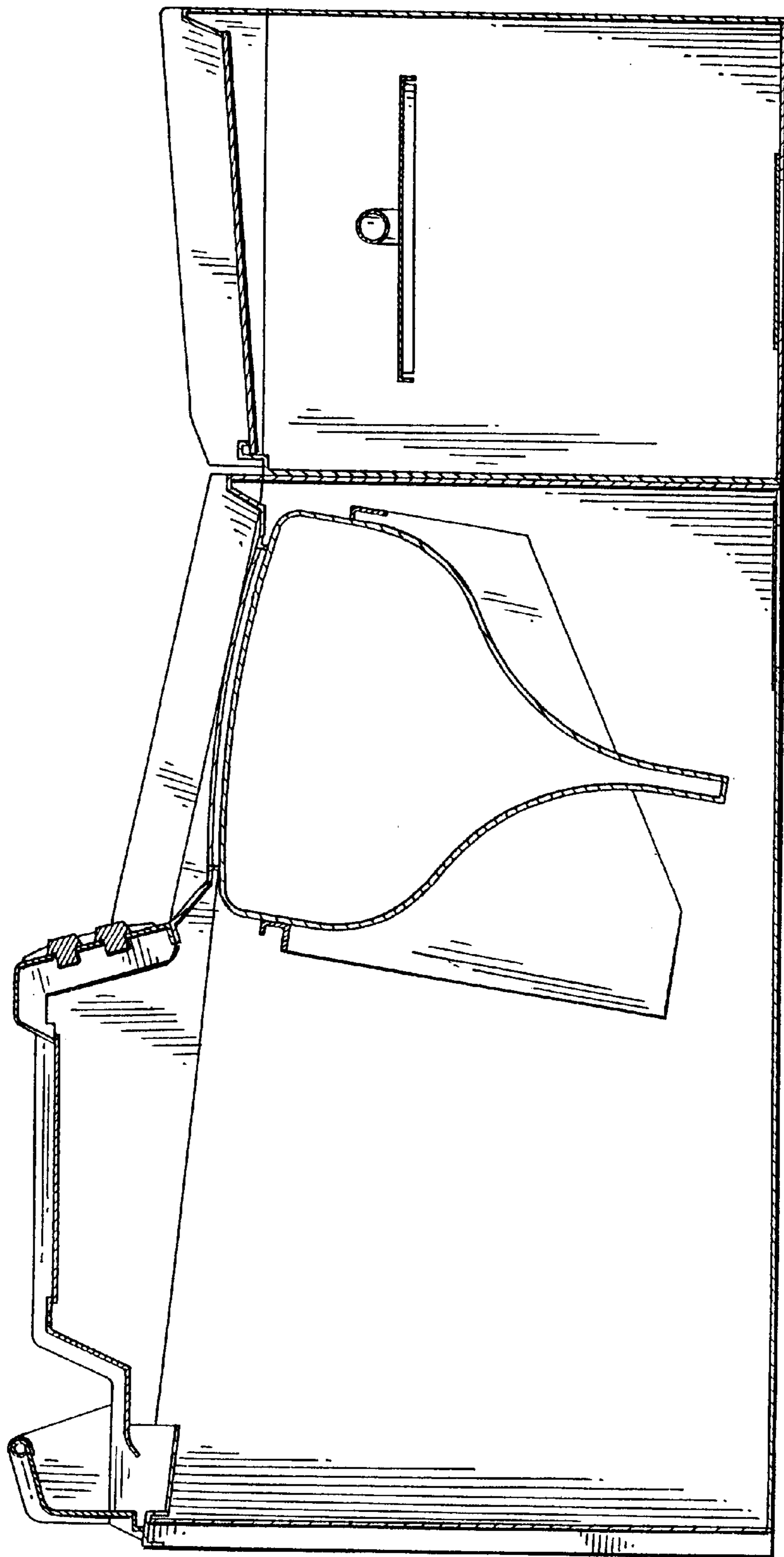

FIG. 23

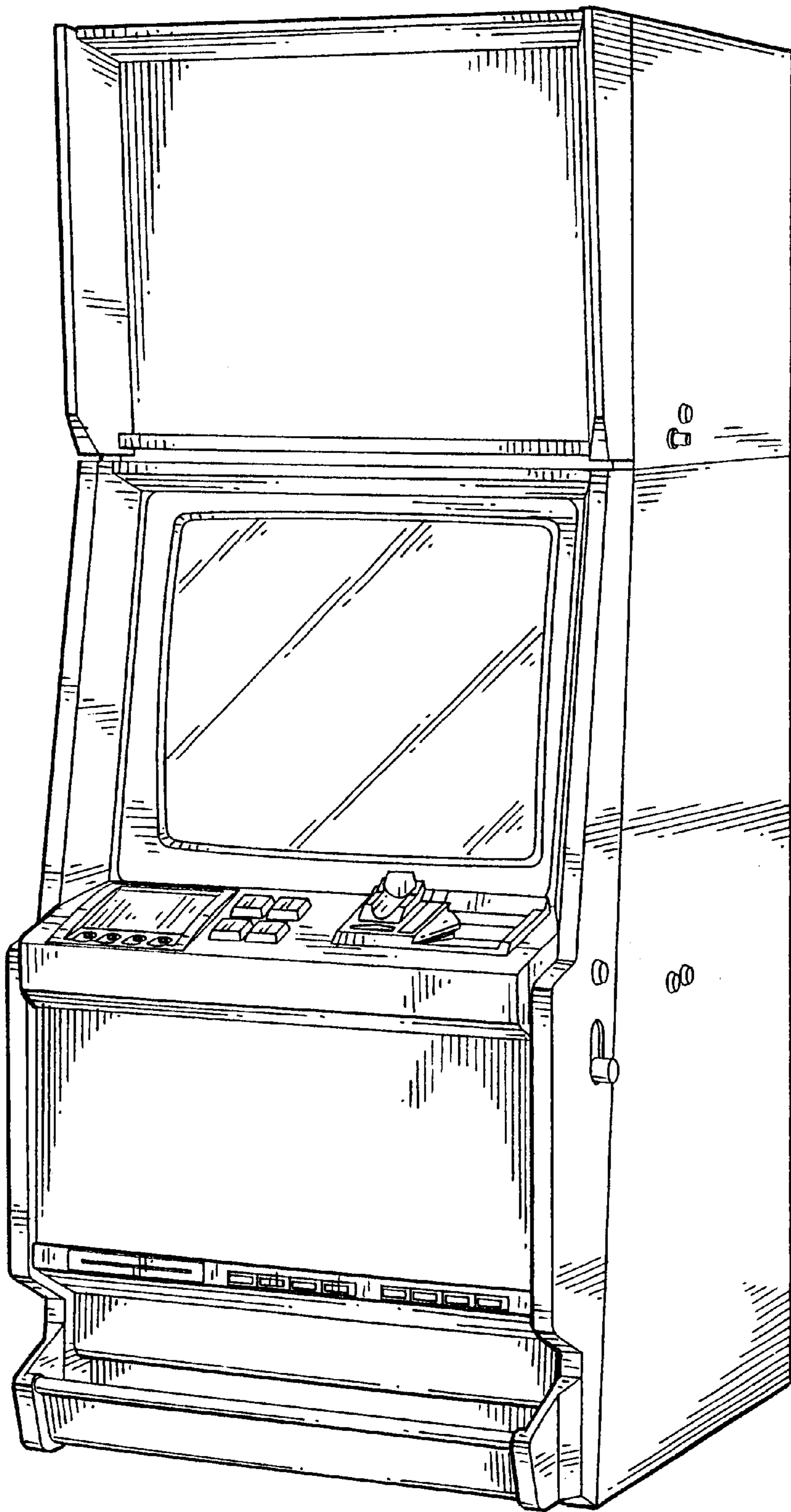

FIG. 24

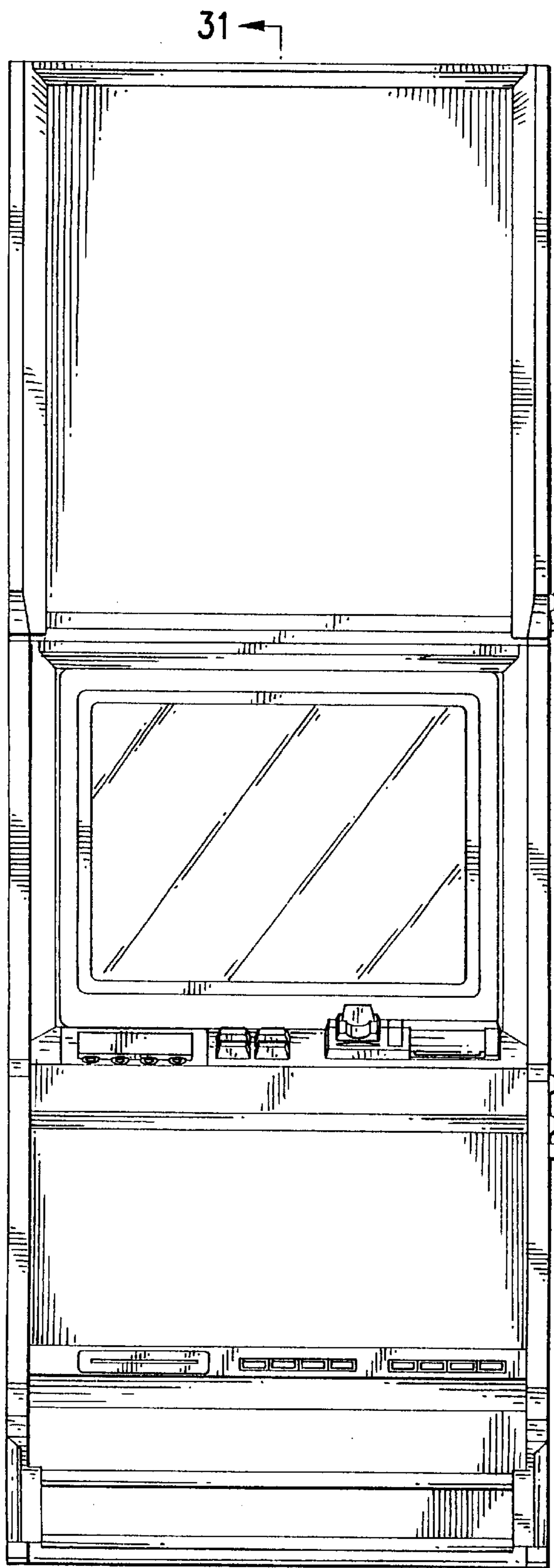

FIG. 25

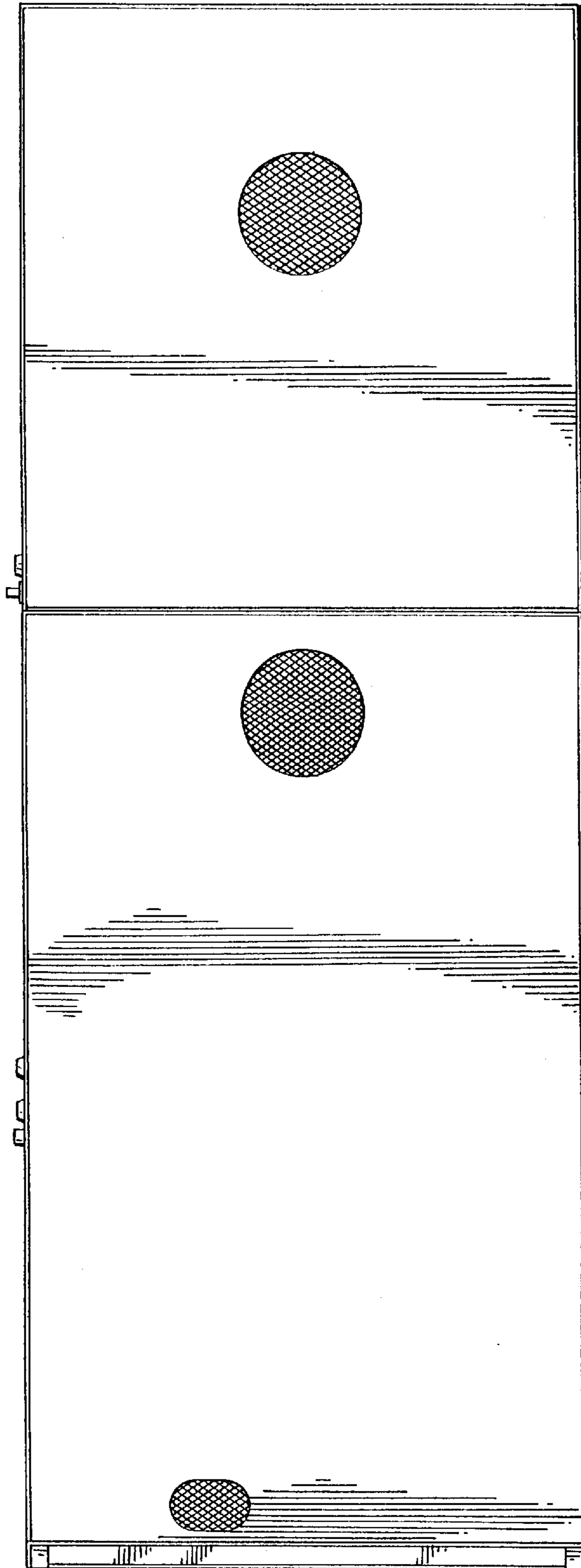

FIG. 26

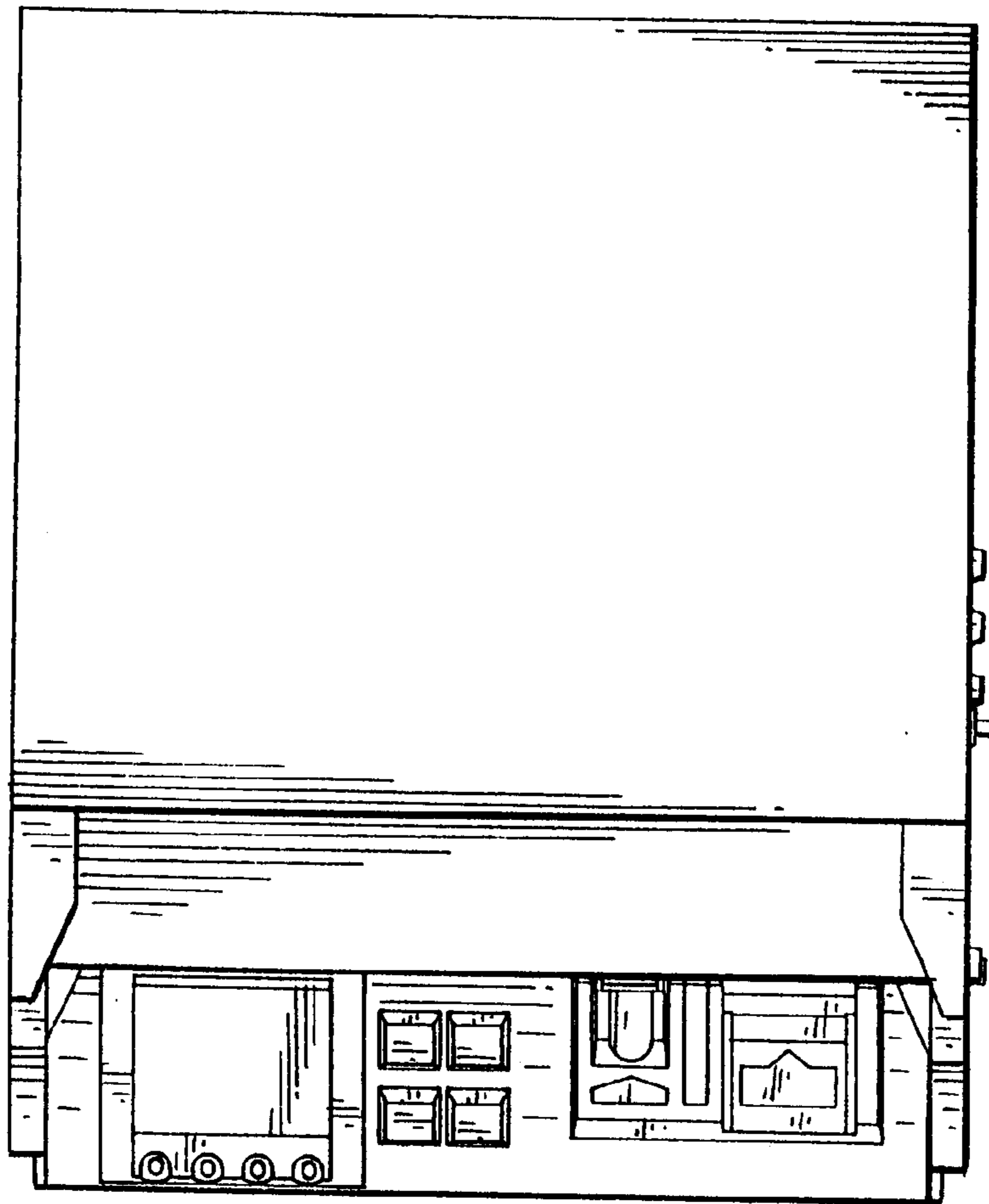

FIG. 27

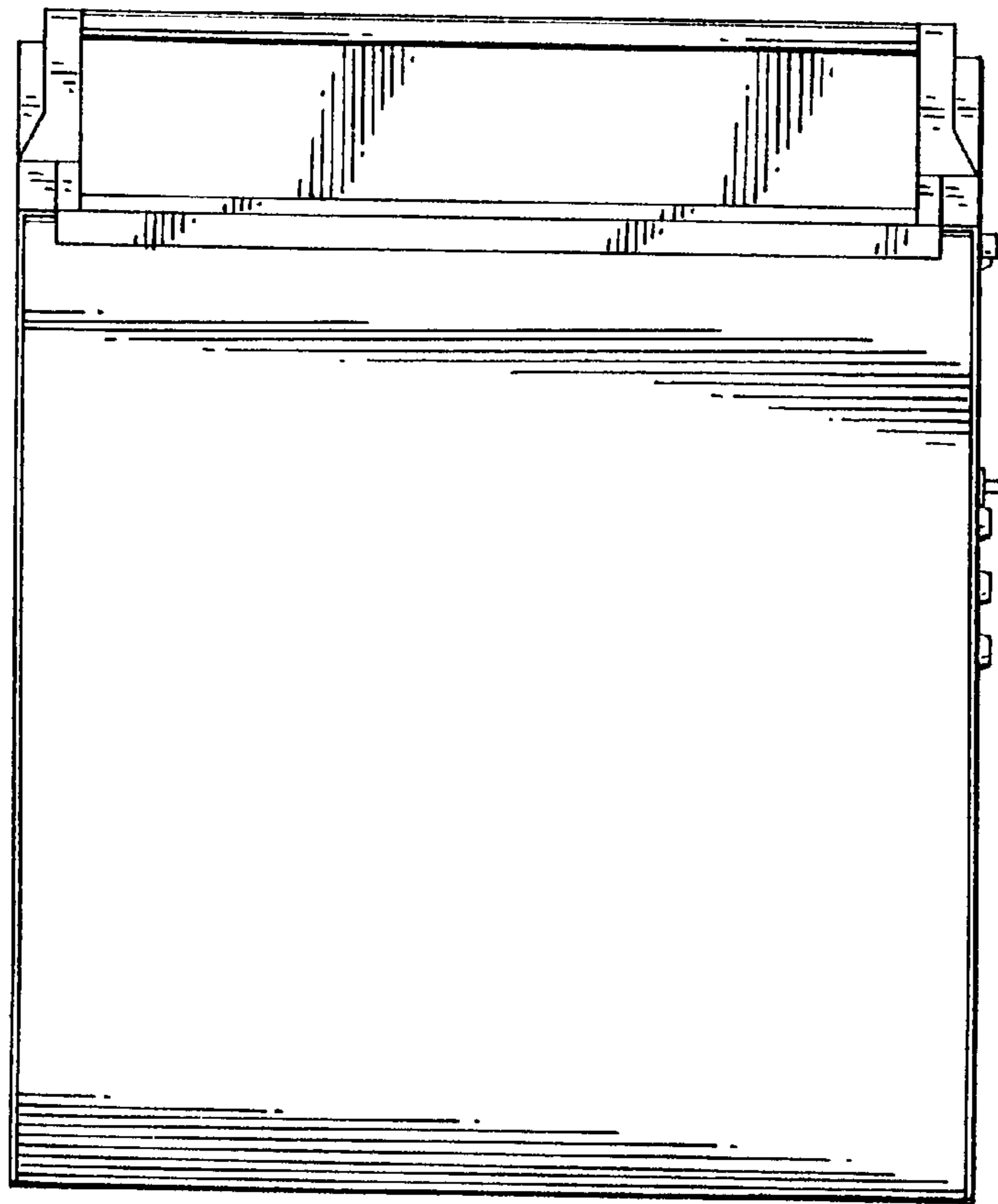

FIG. 28

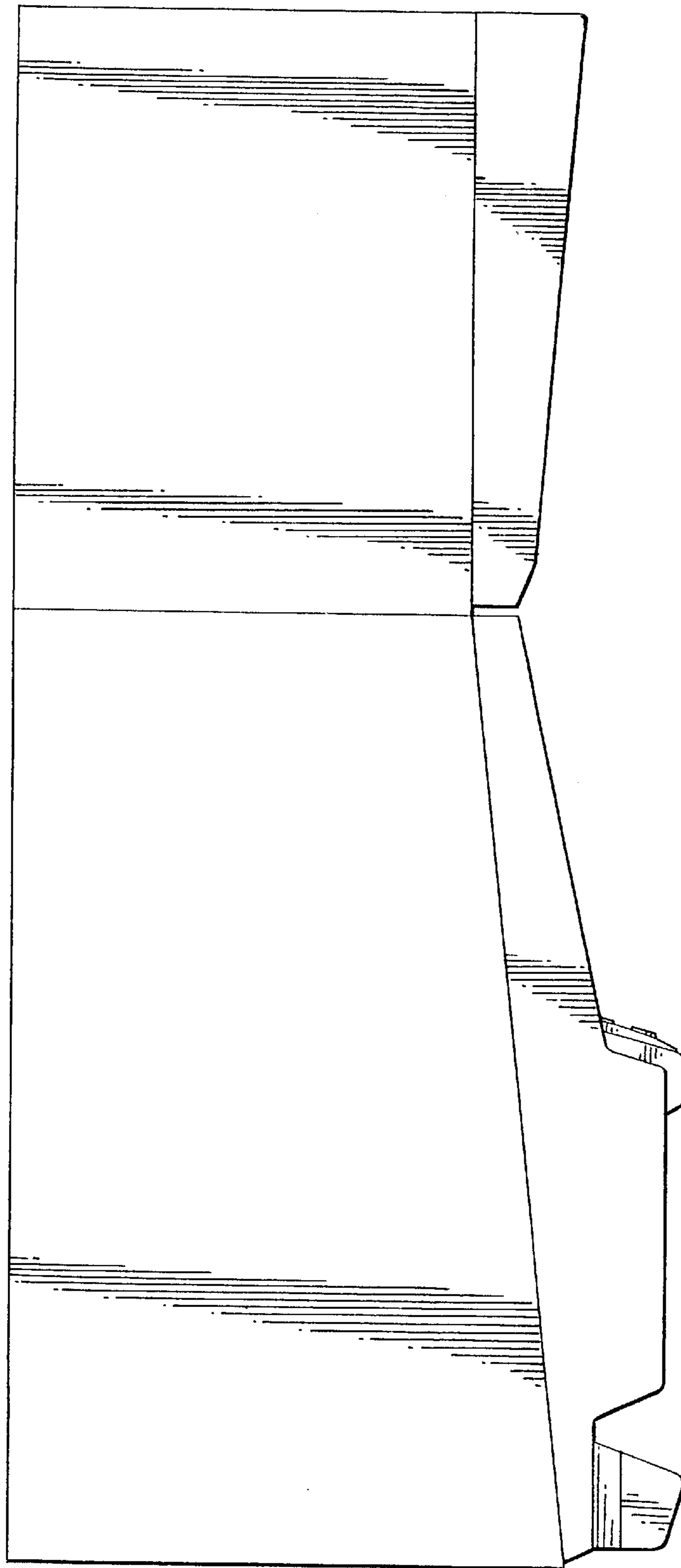

FIG. 29

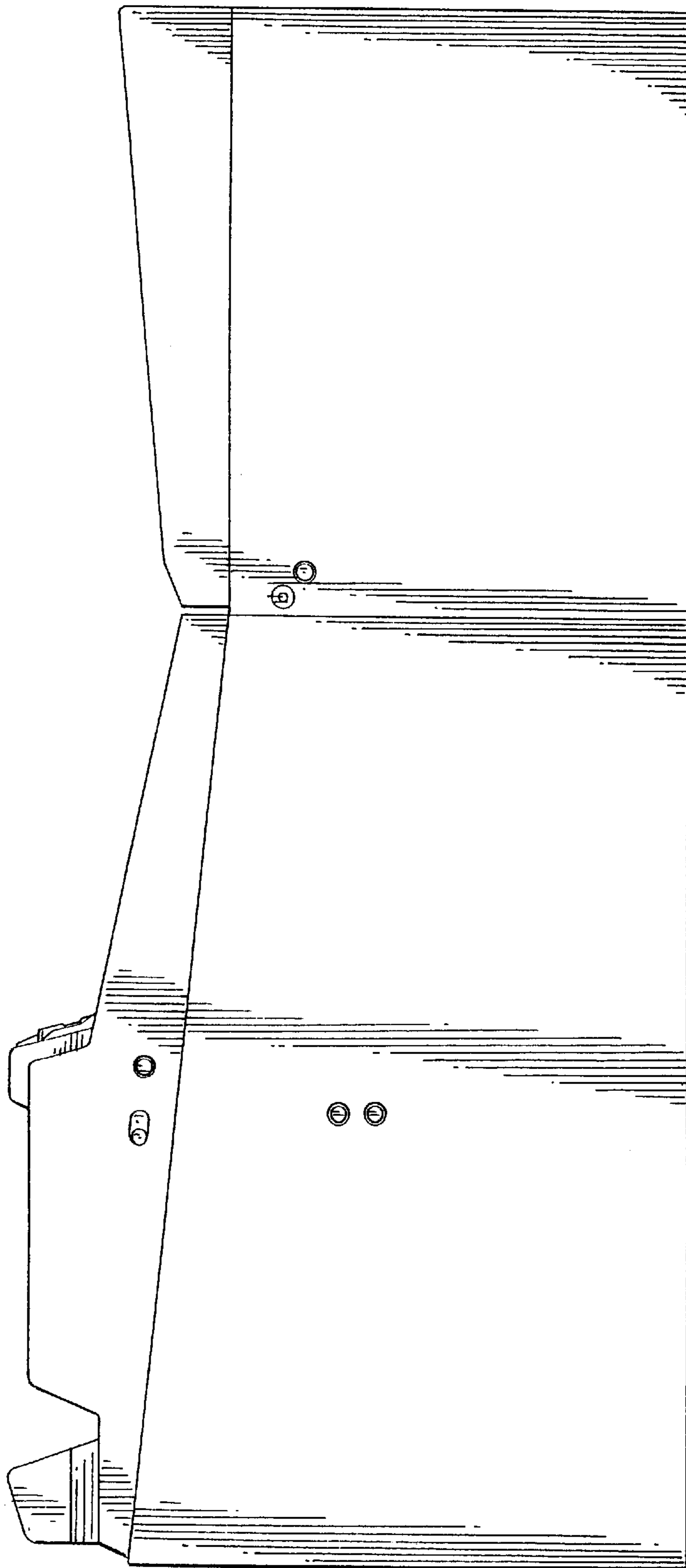

FIG. 30

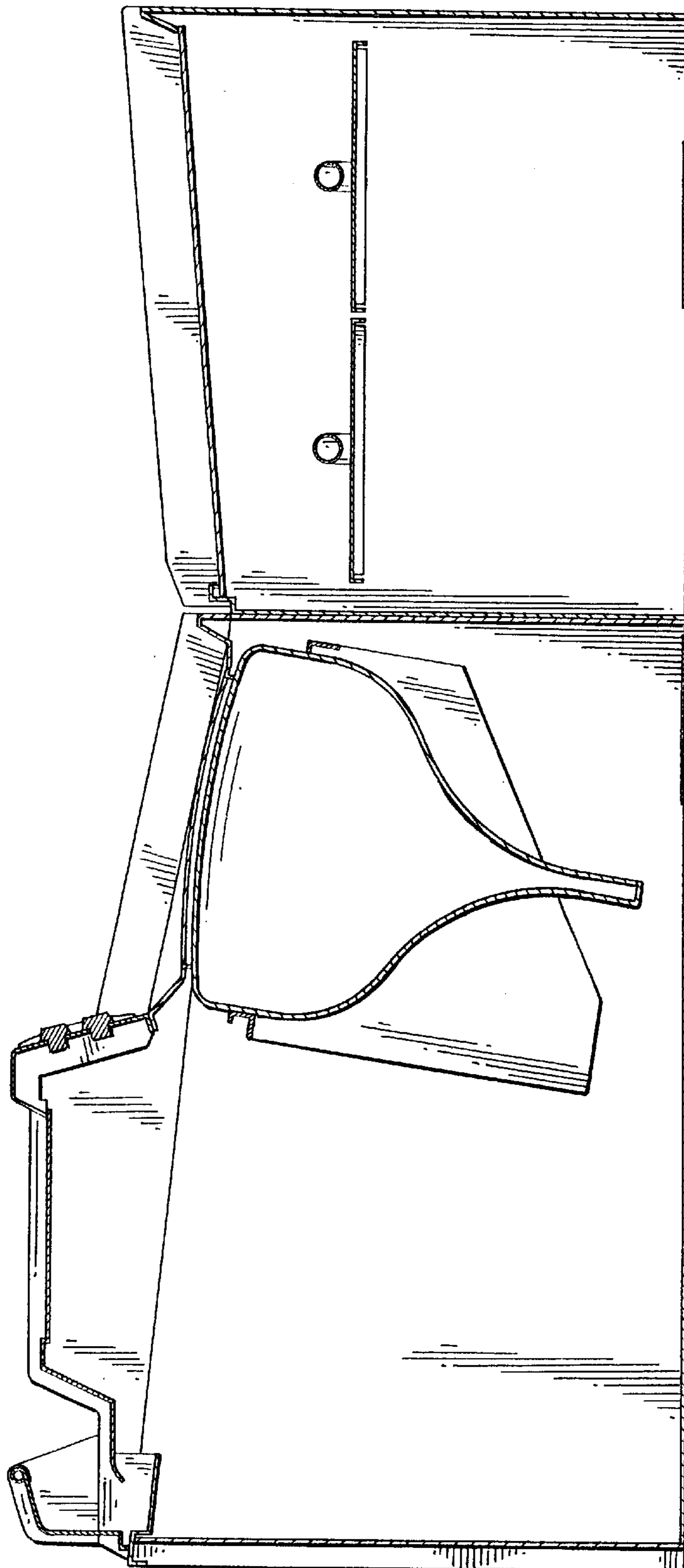

FIG. 31

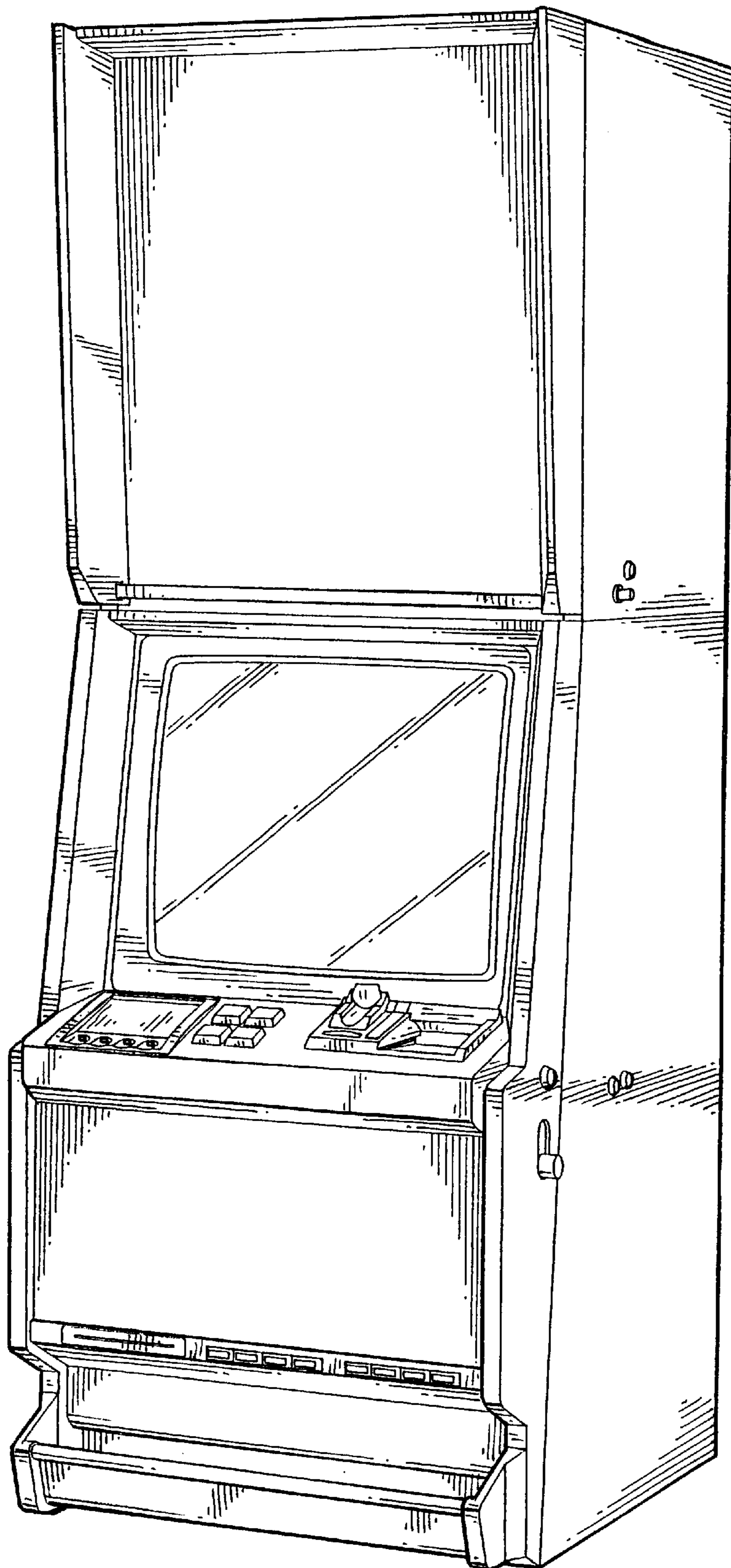

FIG. 32