



US00D442564S

(12) **United States Design Patent**  
**Ohkuma**

(10) **Patent No.:** **US D442,564 S**

(45) **Date of Patent:** **\*\* May 22, 2001**

(54) **REMOTE CONTROLLER FOR MASSAGE CHAIR**

5,606,143 \* 2/1997 Young ..... D13/168 X

\* cited by examiner

(75) Inventor: **Yumiko Ohkuma**, Tokyo (JP)

*Primary Examiner*—Brian N. Vinson

(73) Assignee: **Toshiba Tec Kabushiki Kaisha** (JP)

(74) *Attorney, Agent, or Firm*—Morrison Law Firm

(\*\*) Term: **14 Years**

(57) **CLAIM**

(21) Appl. No.: **29/126,616**

The ornamental design for a remote controller for massage chair, as shown and described.

(22) Filed: **Jul. 20, 2000**

**DESCRIPTION**

(30) **Foreign Application Priority Data**

Jan. 21, 2000 (JP) ..... 12-000747

(51) **LOC (7) Cl.** ..... **14-03**

(52) **U.S. Cl.** ..... **D13/168**

(58) **Field of Search** ..... D13/168; D14/114,  
D14/117.1, 117.9, 218; 340/825.72; 341/176;  
455/419, 90, 91, 92, 95, 151.1, 151.2, 352

FIG. 1 is a top, right side perspective view of a remote controller for massage chair showing my design;  
FIG. 2 is a bottom, rear side perspective view thereof;  
FIG. 3 is a top plan view thereof;  
FIG. 4 is a bottom plan view thereof;  
FIG. 5 is a left side elevational view thereof, the right side being the same;  
FIG. 6 is a rear end elevational view thereof;  
FIG. 7 is a front end elevational view thereof;  
FIG. 8 a top plan view thereof when a top cover has been slid from a rear to a front cover position;  
FIG. 9 is the same as FIG. 3 but with an indication signal showing; and,  
FIG. 10 is the same as FIG. 8 but with an indication signal showing.

(56) **References Cited**

**U.S. PATENT DOCUMENTS**

- D. 302,544 \* 8/1989 Spira ..... D13/168
- D. 322,611 \* 12/1991 Bang ..... D14/218
- D. 363,550 \* 10/1995 Teo et al. .... D13/168 X
- D. 389,806 \* 1/1998 Nielsen ..... D13/168
- D. 399,209 \* 10/1998 Yamagishi ..... D14/218
- D. 407,695 \* 4/1999 Hwang ..... D13/168

**1 Claim, 4 Drawing Sheets**

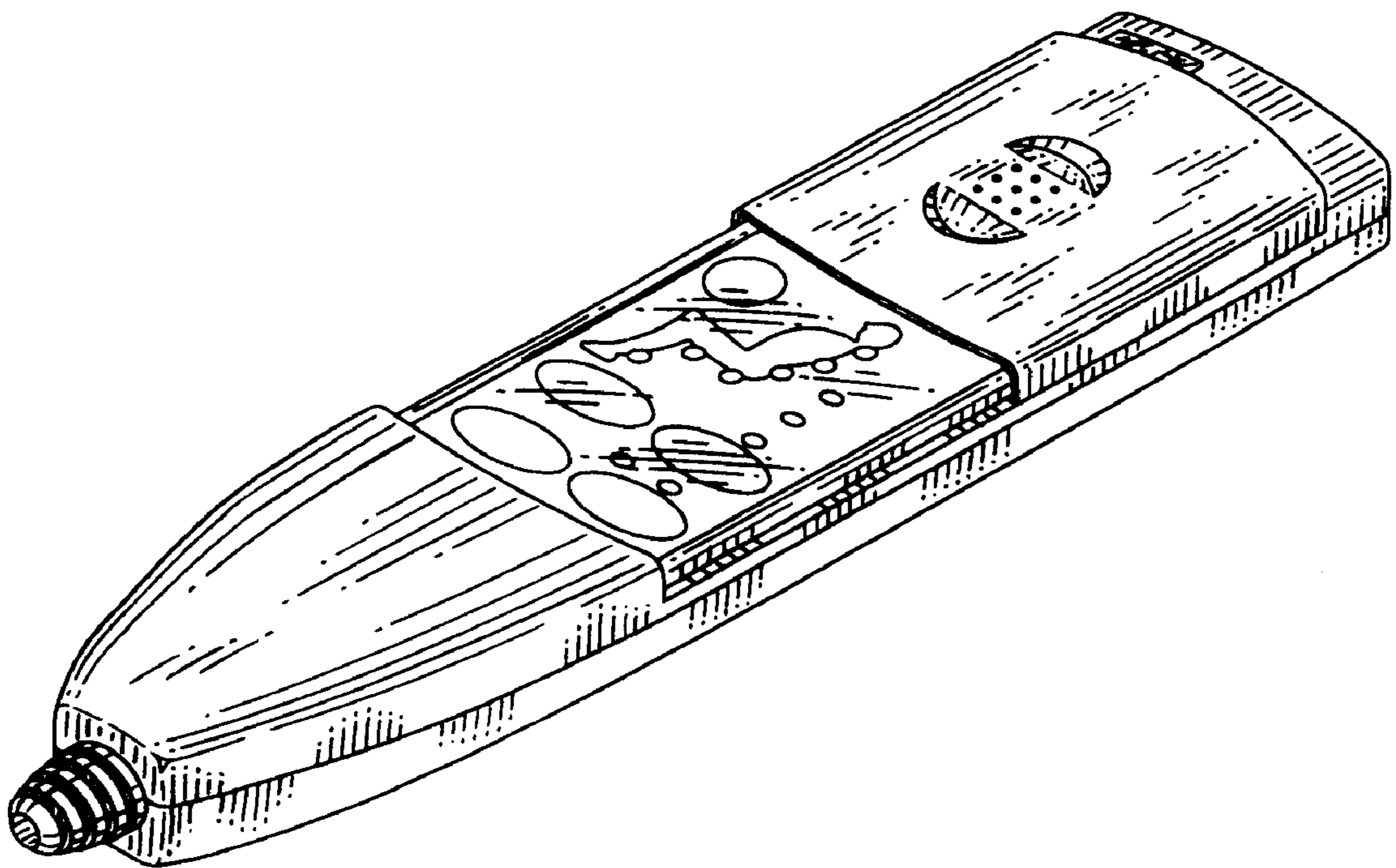

FIG. 1

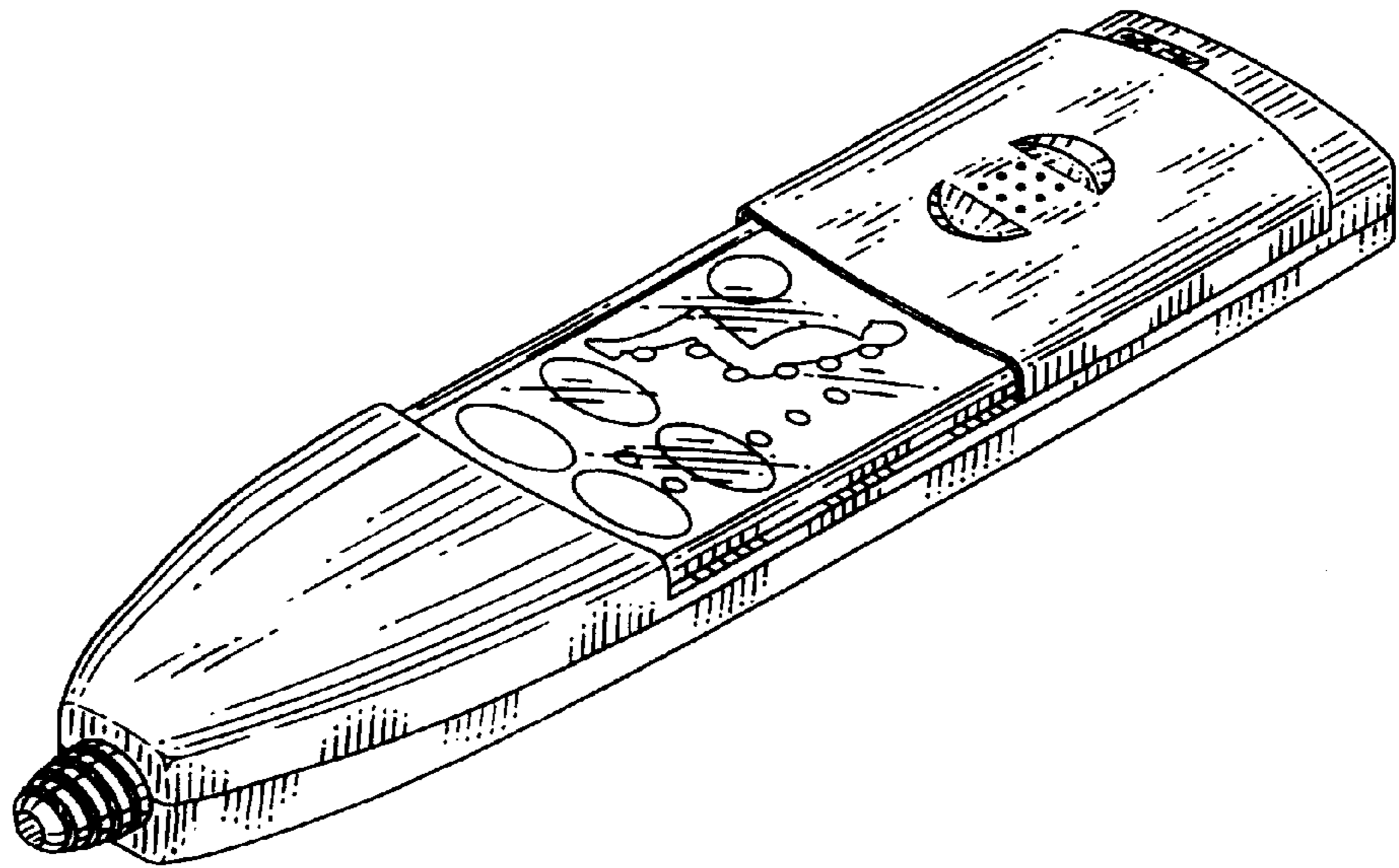

FIG. 2

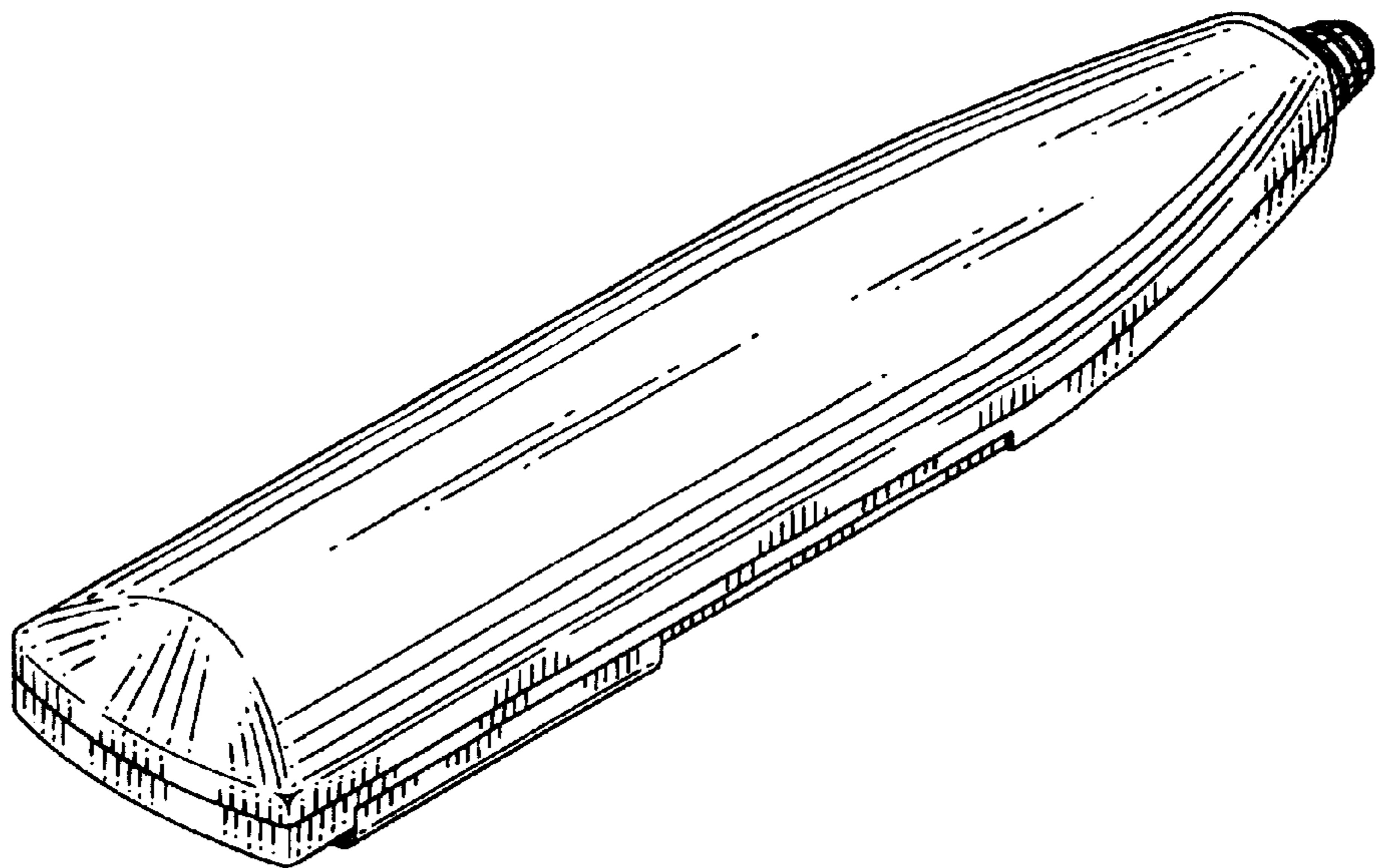

FIG. 3

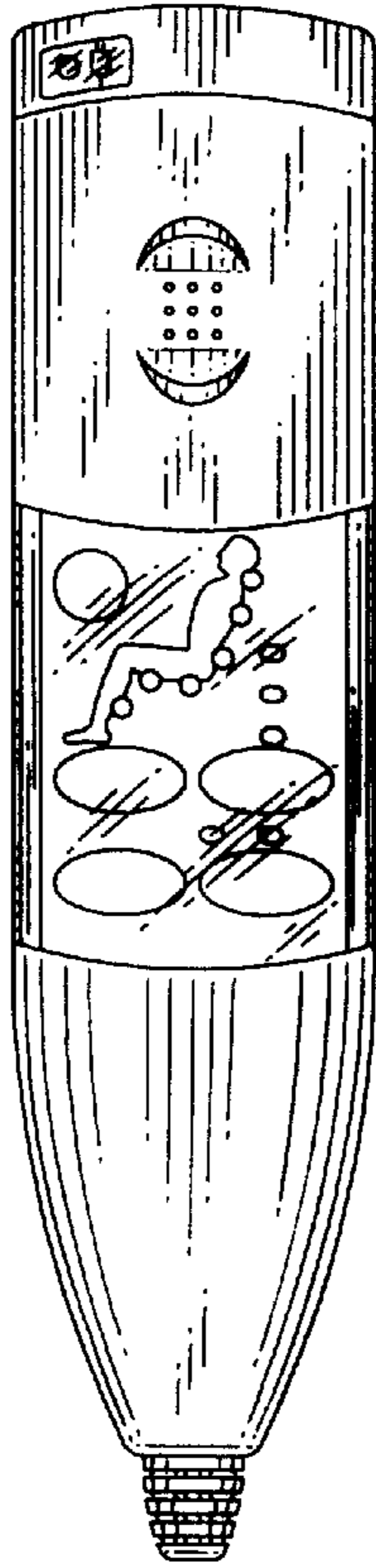

FIG. 4

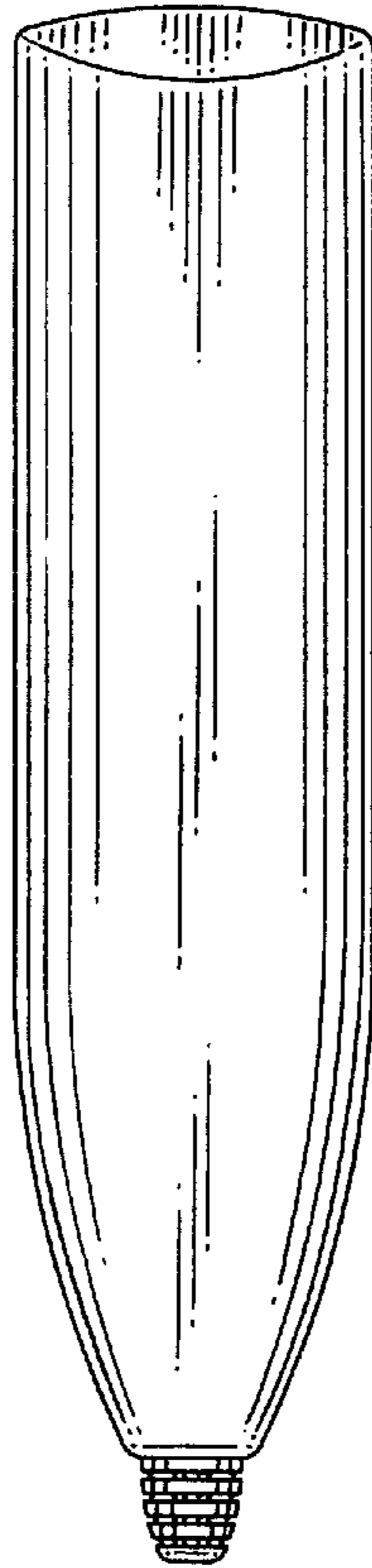

FIG. 5

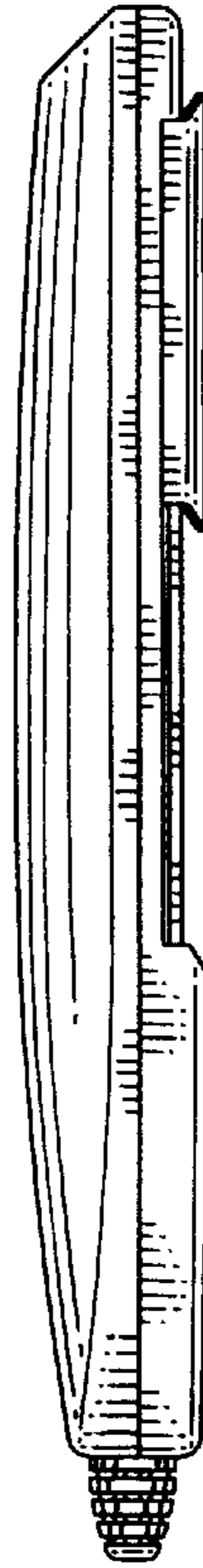

FIG. 6

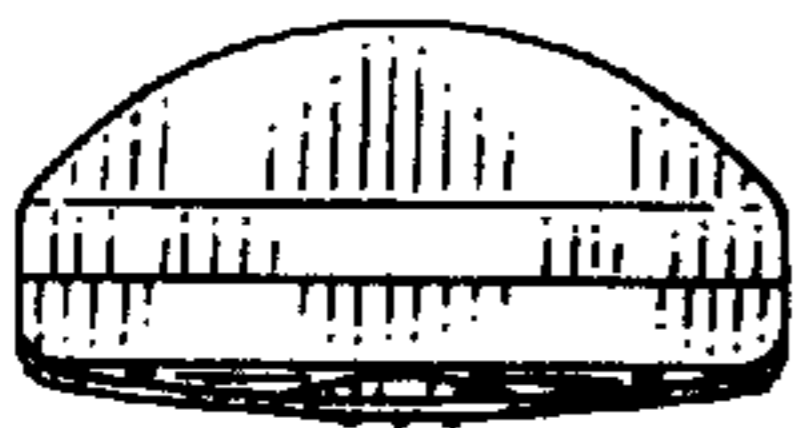

FIG. 7

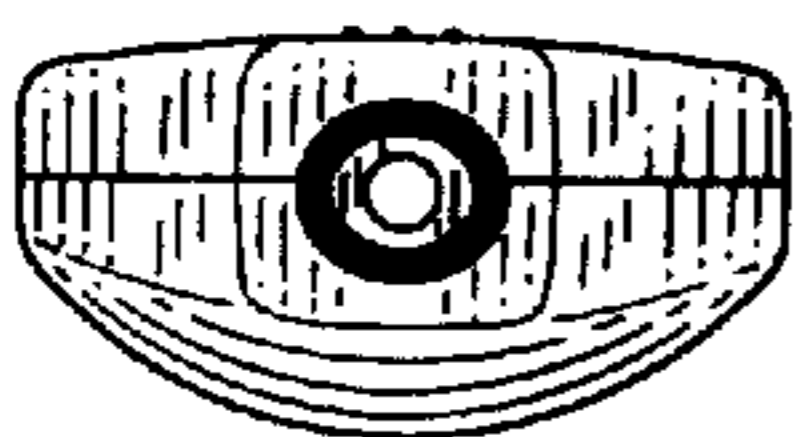

FIG. 8

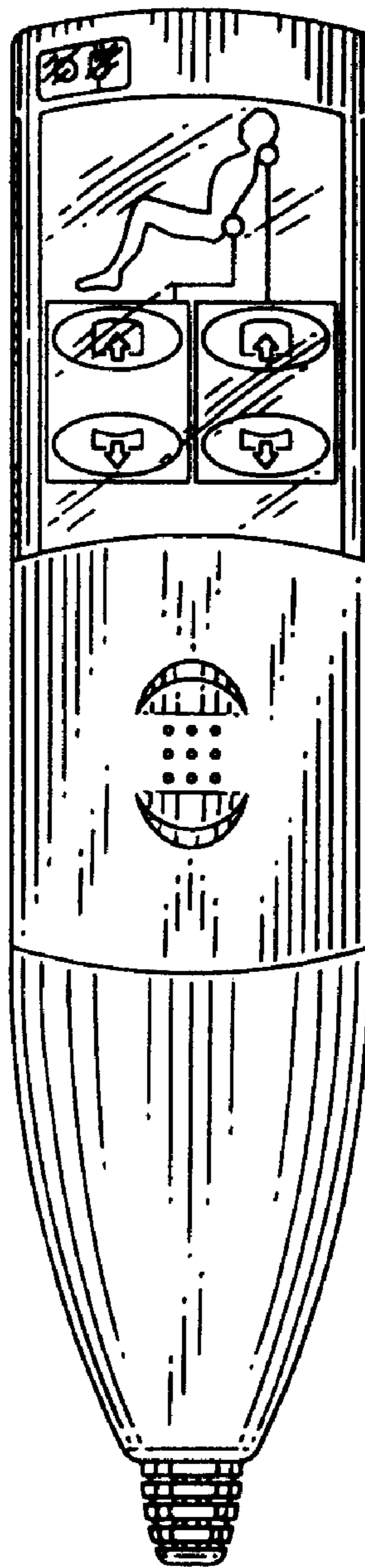

FIG. 9

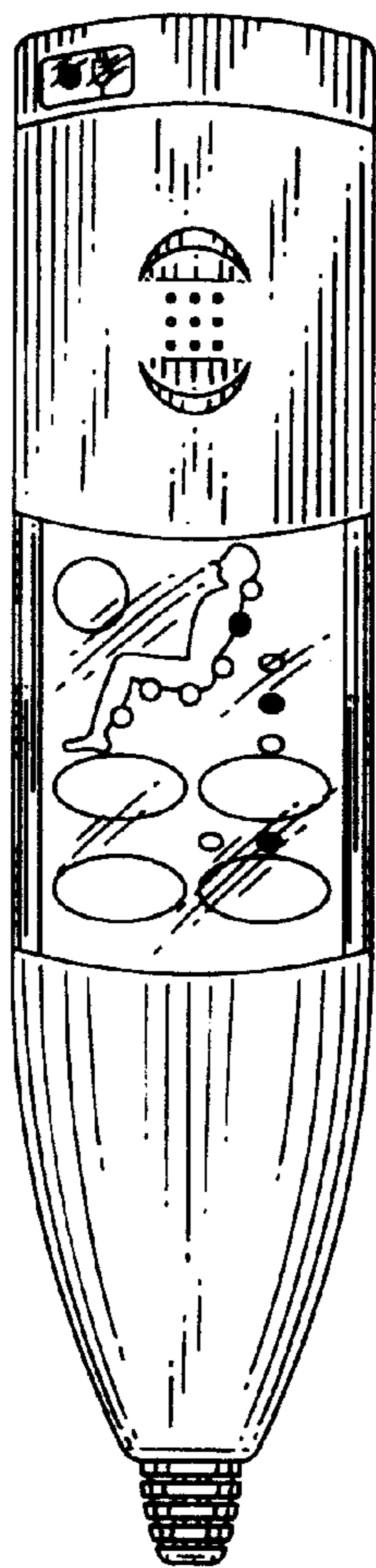

FIG. 10

