



US00D442500S

(12) **United States Design Patent**
Moriai

(10) **Patent No.:** **US D442,500 S**

(45) **Date of Patent:** **** May 22, 2001**

(54) **WATCH CASE**

(75) **Inventor:** **Ryusuke Moriai, Ome (JP)**

(73) **Assignee:** **Casio Keisanki Kabushiki Kaisha, Tokyo (JP)**

(**) **Term:** **14 Years**

(21) **Appl. No.:** **29/132,570**

(22) **Filed:** **Nov. 9, 2000**

(51) **LOC (7) Cl.** **10-02**

(52) **U.S. Cl.** **D10/30; D10/38**

(58) **Field of Search** **D10/1-40, 122-132; 368/280-282, 276-277, 28-30, 285, 239-242, 82-84, 41-44**

(56) **References Cited**

U.S. PATENT DOCUMENTS

- D. 378,198 * 2/1997 Tomita et al. D10/38
- D. 387,679 * 12/1997 Hanagata D10/31
- D. 387,680 * 12/1997 Hanagata D10/31
- D. 394,401 * 5/1998 Moriai et al. D10/30
- D. 396,644 * 8/1998 Moriai D10/30

- D. 401,160 * 11/1998 Akagi D10/30
- D. 407,330 * 3/1999 Ishizaka D10/30
- D. 417,400 * 12/1999 Yamamoto D10/30
- D. 426,780 * 6/2000 Goto et al. D10/30

* cited by examiner

Primary Examiner—Nelson C. Holtje

(74) *Attorney, Agent, or Firm*—Frishauf, Holtz, Goodman, Langer & Chick, P.C.

(57) **CLAIM**

The ornamental design for a watch case, as shown.

DESCRIPTION

FIG. 1 is a front elevational view of a watch case, showing my new design;
 FIG. 2 is a right side elevational view thereof;
 FIG. 3 is a left side elevational view thereof;
 FIG. 4 is a top plan view thereof;
 FIG. 5 is a bottom plan view thereof;
 FIG. 6 is a rear elevational view thereof; and,
 FIG. 7 is a front, bottom and right side perspective view thereof.

1 Claim, 3 Drawing Sheets

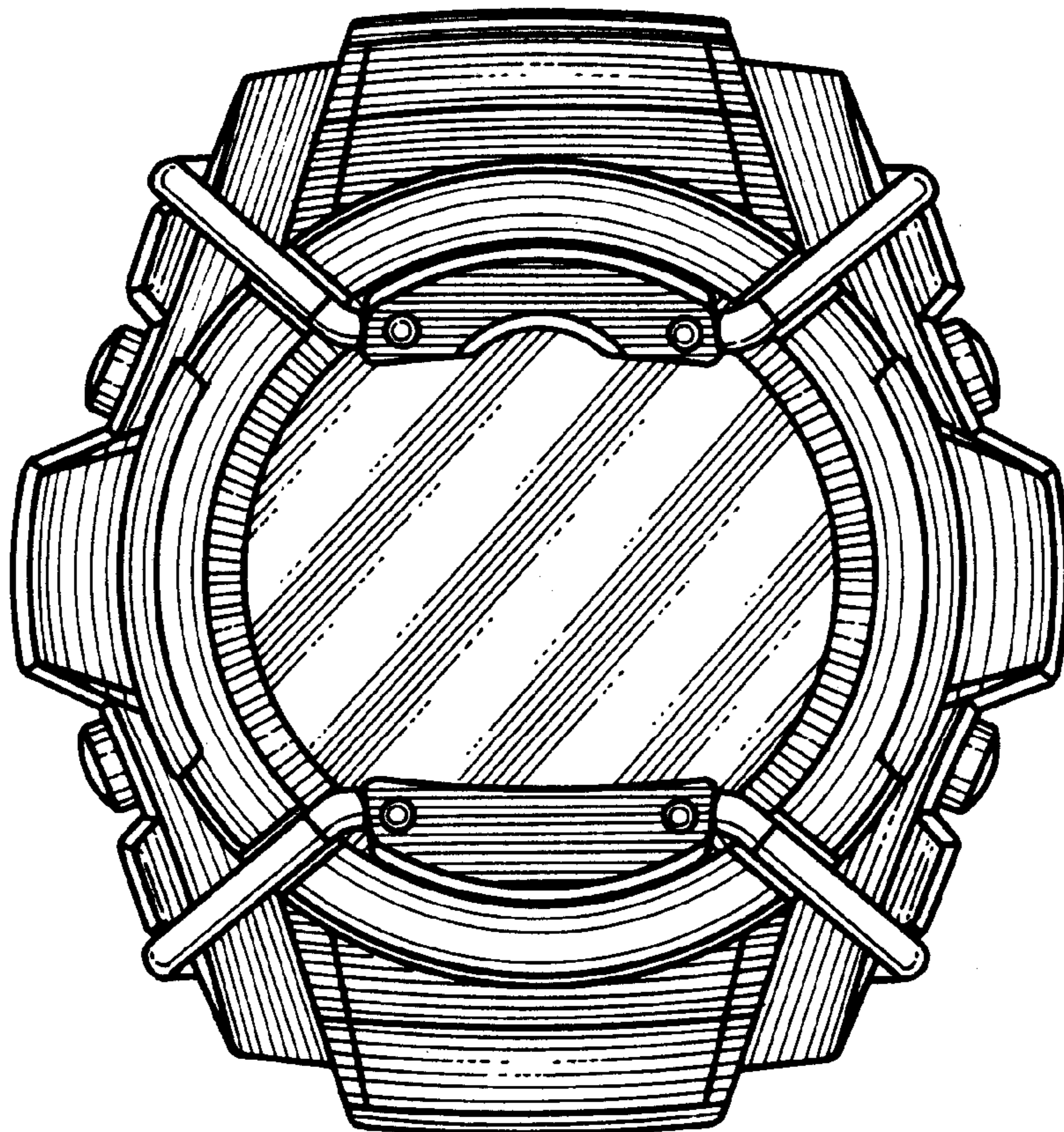

FIG. 1

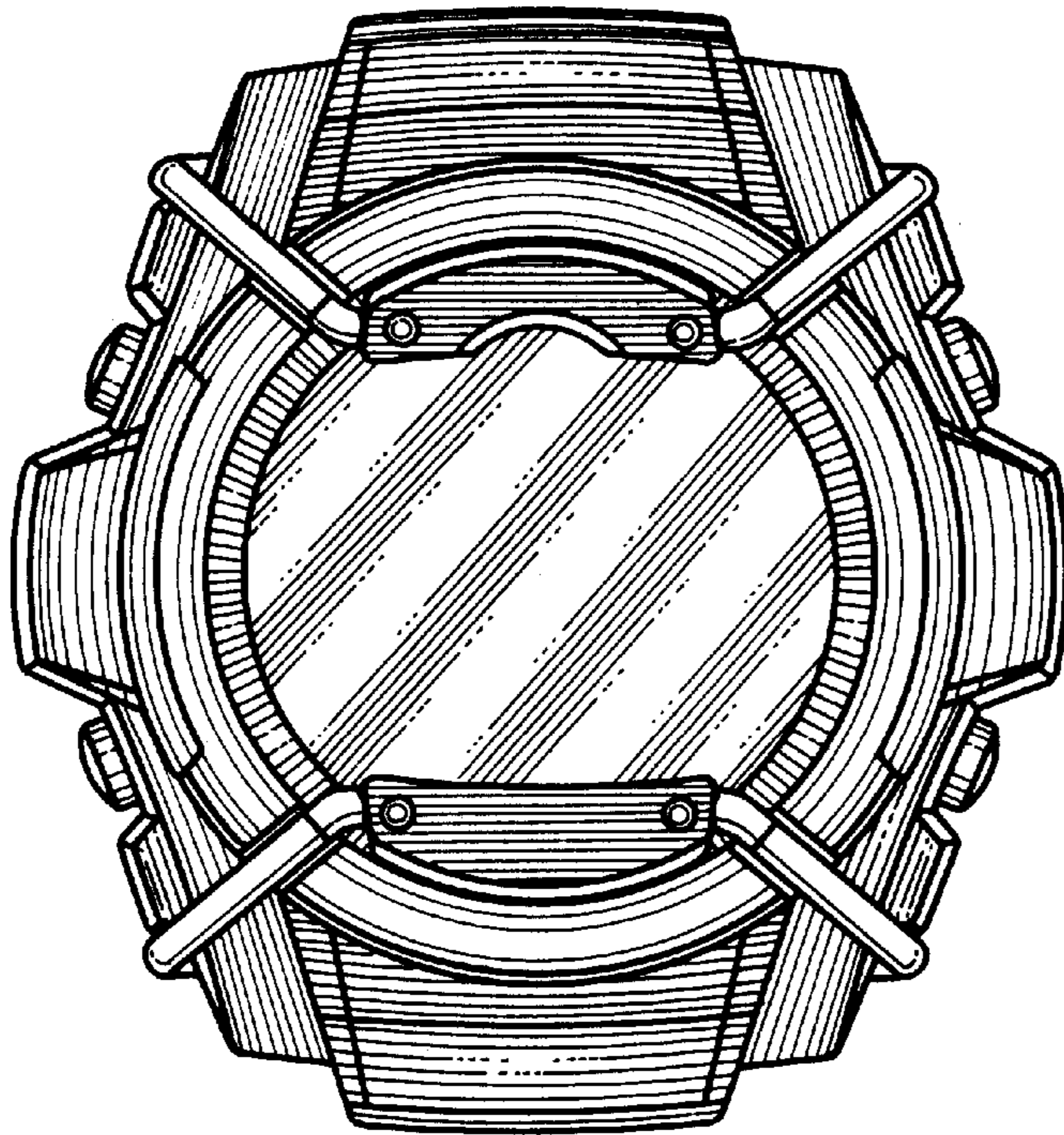

FIG. 2

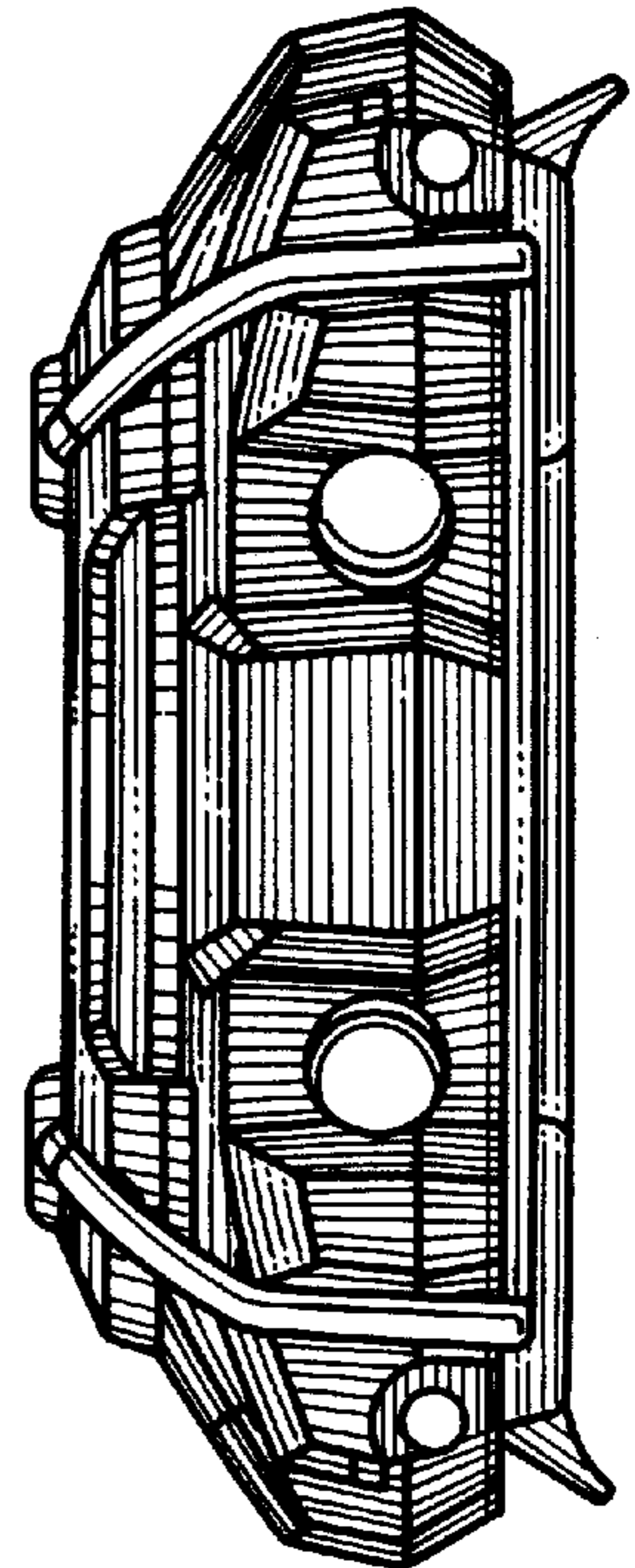

FIG. 5

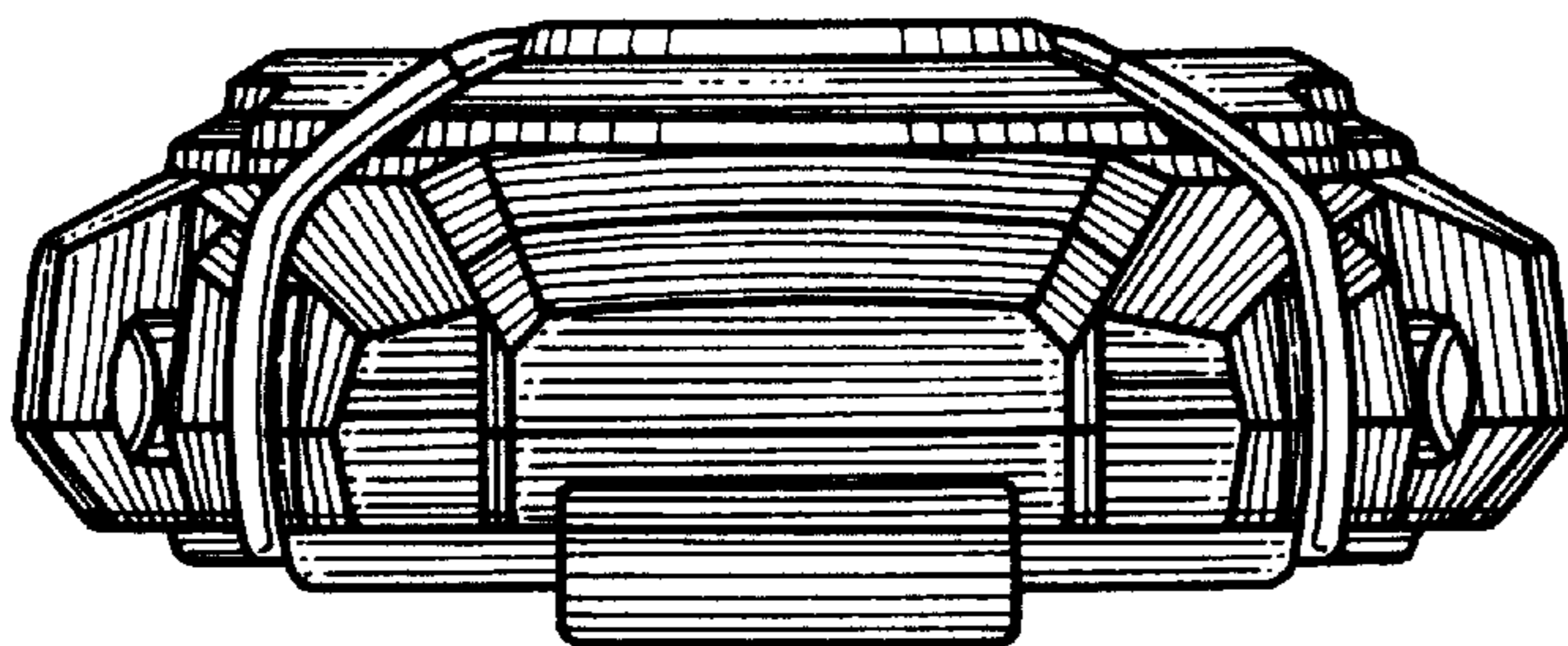

FIG. 4

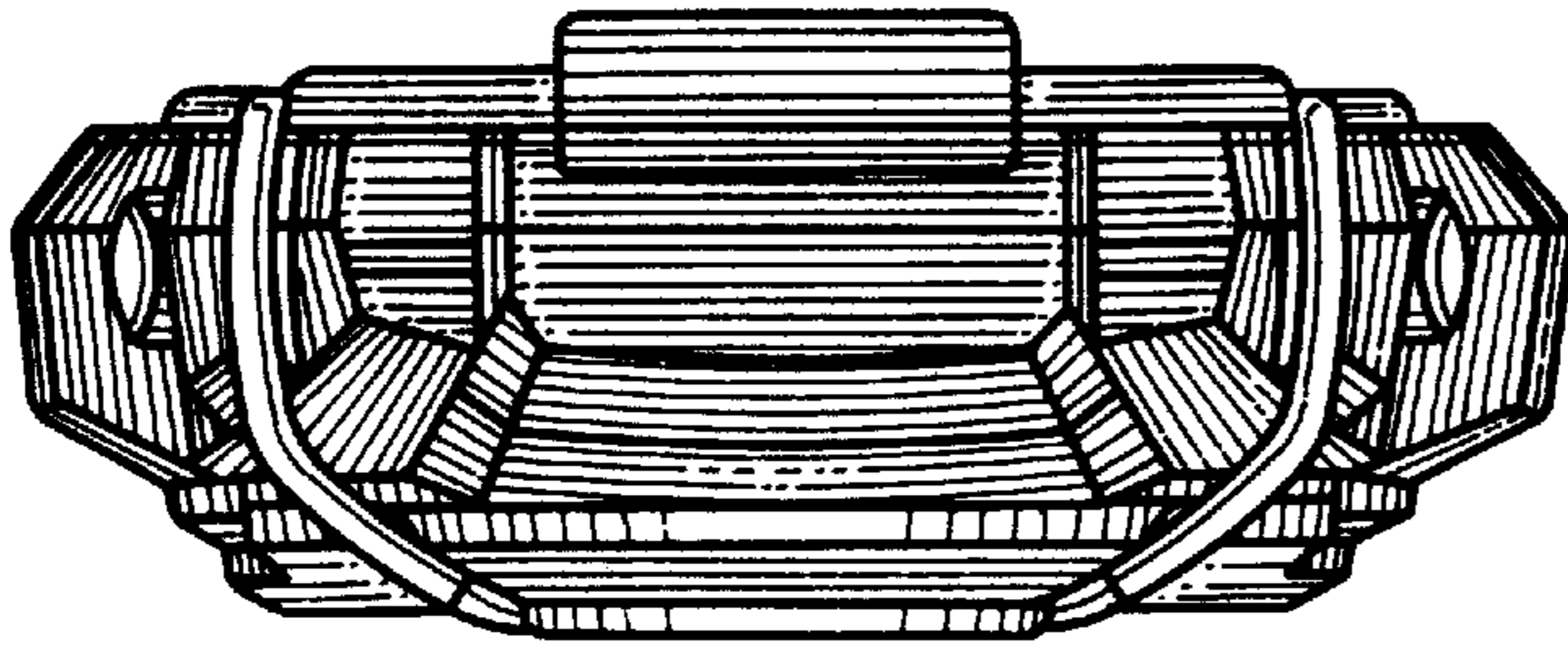

FIG. 6

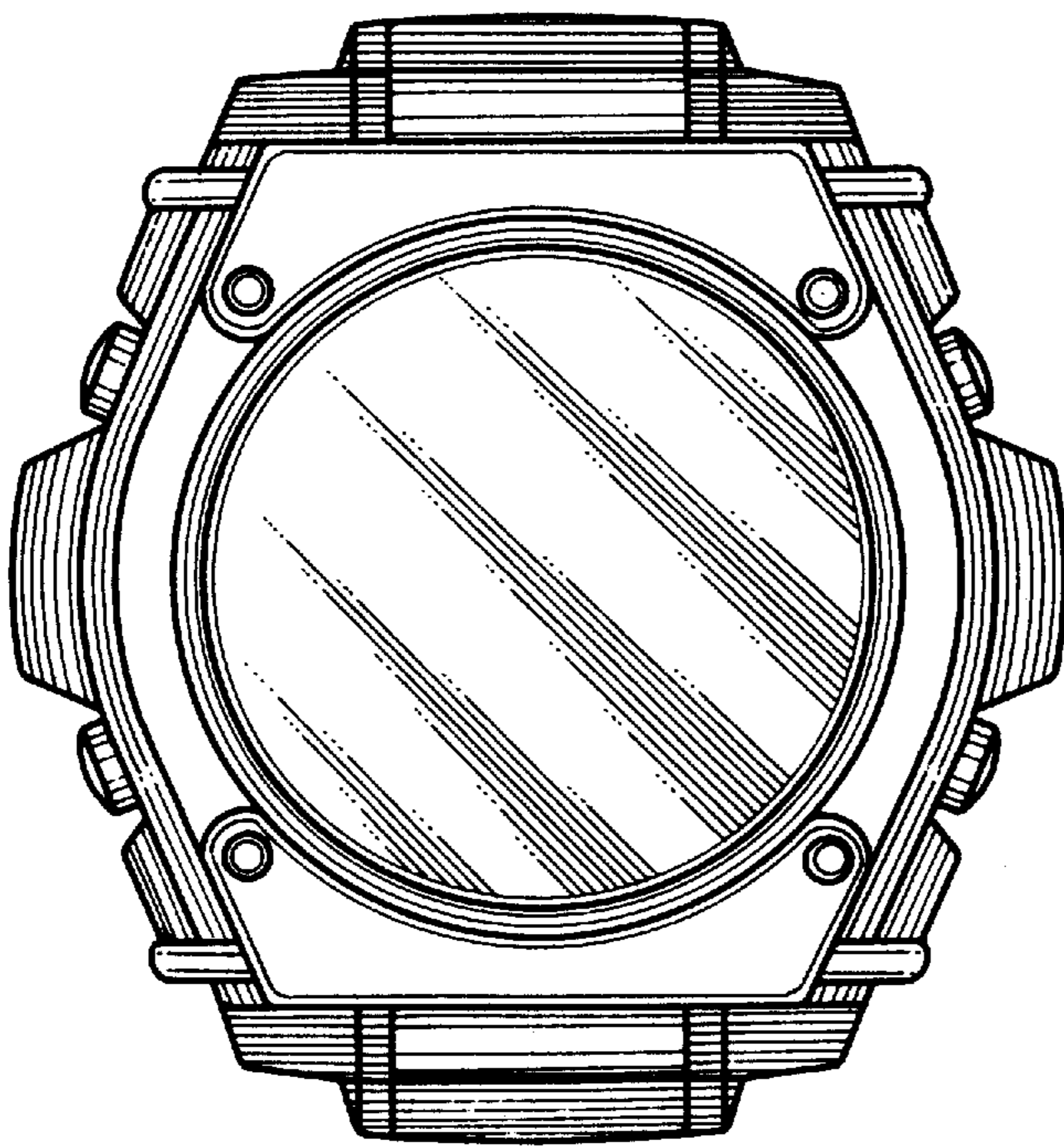

FIG. 3

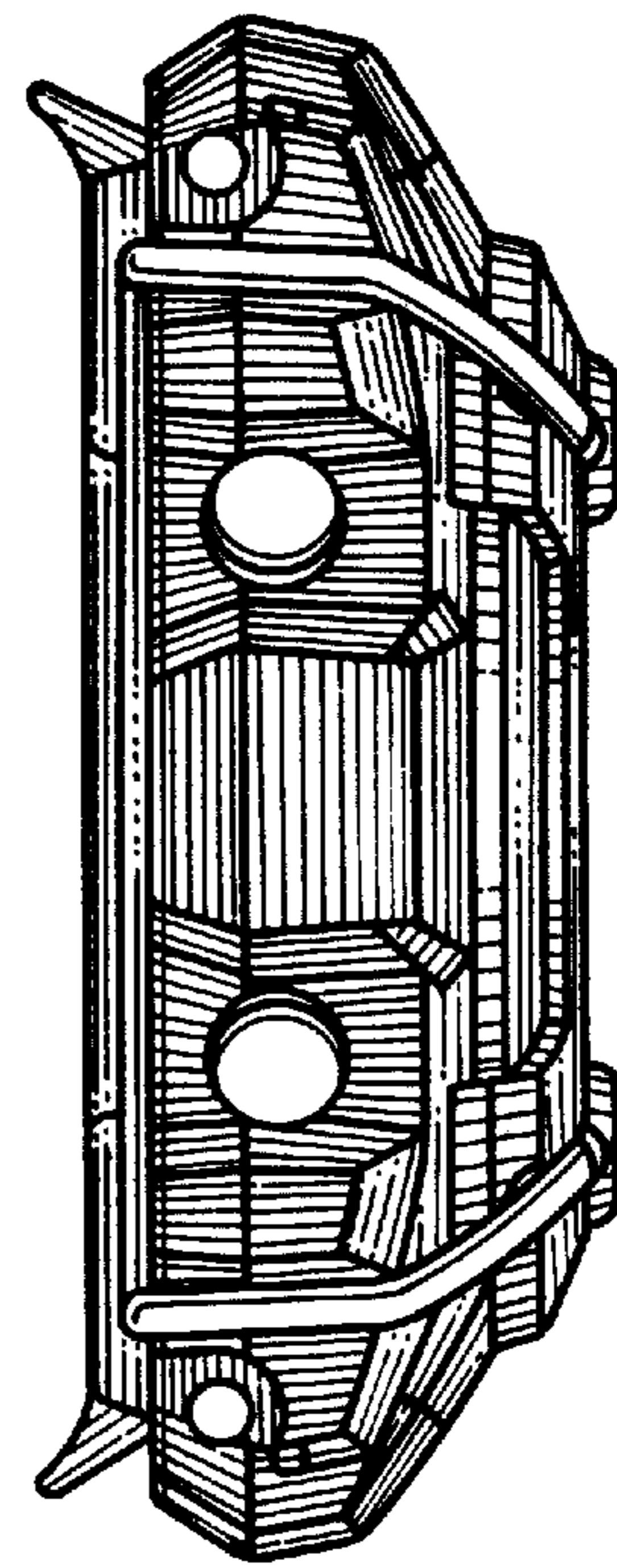

FIG. 7

