



US00D442413S

(12) **United States Design Patent**  
**Ishii**

(10) **Patent No.:** **US D442,413 S**

(45) **Date of Patent:** **\*\* May 22, 2001**

(54) **END COVER FOR STRINGS**

(75) Inventor: **Yosuke Ishii**, Kawanishi (JP)

(73) Assignee: **Nifco Inc.**, Yokohama (JP)

(\*\*) Term: **14 Years**

(21) Appl. No.: **29/113,470**

(22) Filed: **Nov. 8, 1999**

(30) **Foreign Application Priority Data**

May 17, 1999 (JP) ..... 11-12545

(51) **LOC (7) Cl.** ..... **06-10**

(52) **U.S. Cl.** ..... **D6/581**

(58) **Field of Search** ..... D6/575, 577, 580,  
D6/581; 160/178.2, 178 R, 349 R, 168.1;  
16/81, 1 R, DIG. 8

(56) **References Cited**

**U.S. PATENT DOCUMENTS**

- D. 288,765 \* 3/1987 Falkenberg et al. .... D6/581
- D. 395,973 \* 7/1998 Huang ..... D6/581
- D. 428,292 \* 7/2000 Anderson ..... D6/581

\* cited by examiner

*Primary Examiner*—Mitchell Siegel

(74) *Attorney, Agent, or Firm*—Kanesaka & Takeuchi

(57) **CLAIM**

The ornamental design for an end cover for strings, as shown and described.

**DESCRIPTION**

FIG. 1 is a front view of an end cover for strings showing my new design, the rear view being symmetrical to the front view;

FIG. 2 is a right side view thereof;

FIG. 3 is a left side view thereof;

FIG. 4 is a top plan view thereof;

FIG. 5 is a bottom plan view thereof;

FIG. 6 is a cross sectional view taken along line 6—6 in FIG. 4;

FIG. 7 is a cross sectional view taken along line 7—7 in FIG. 4;

FIG. 8 is a front view of the end cover for strings in an opened condition;

FIG. 9 is a top plan view of FIG. 8;

FIG. 10 is a bottom plan view of FIG. 8;

FIG. 11 is a right side view of FIG. 8;

FIG. 12 is a left side view of FIG. 8;

FIG. 13 is a cross sectional view taken along line 13—13 in FIG. 9;

FIG. 14 is a cross sectional view taken along line 14—14 in FIG. 9; and,

FIG. 15 is a cross sectional view taken along line 15—15 in FIG. 9.

**1 Claim, 4 Drawing Sheets**

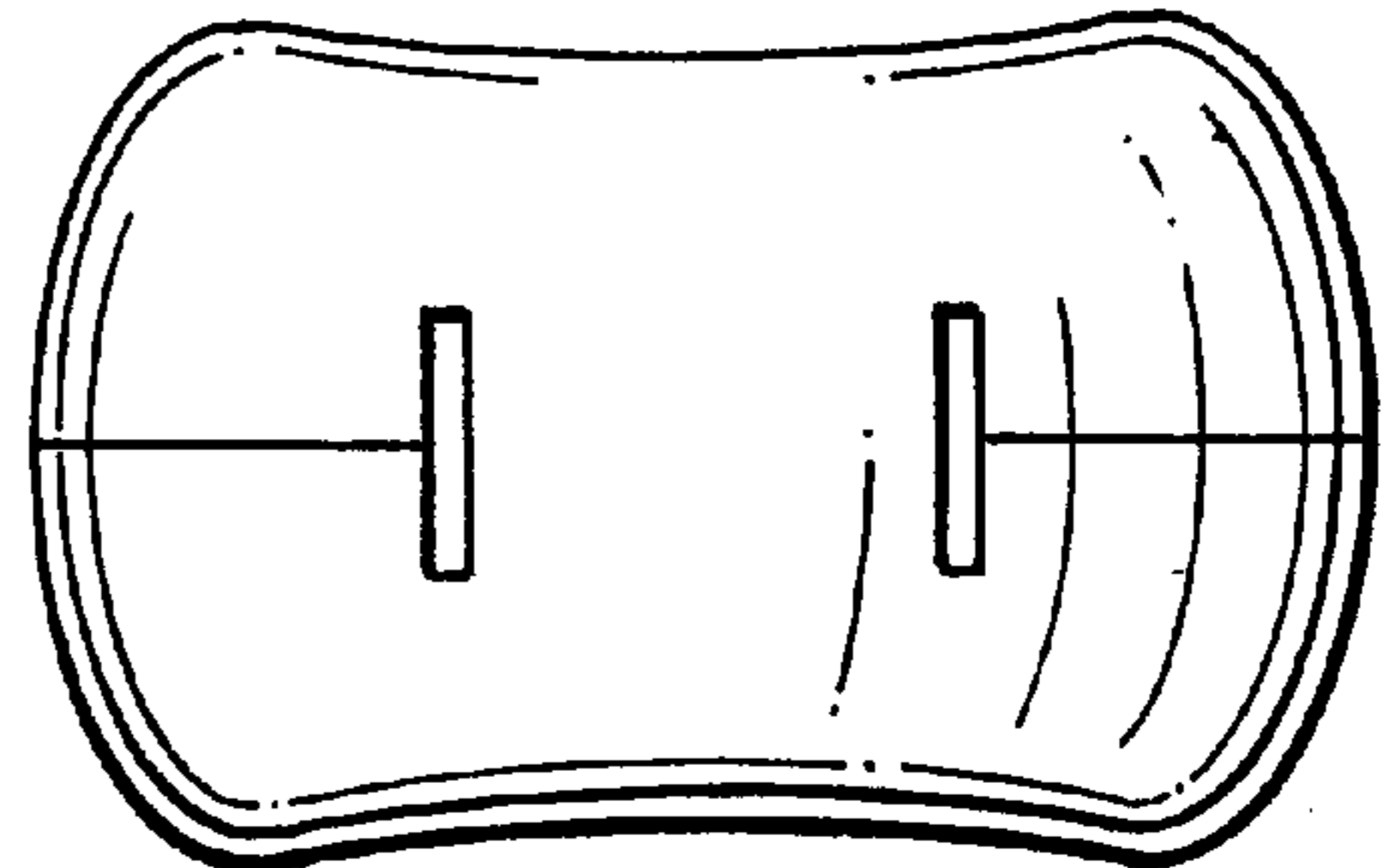
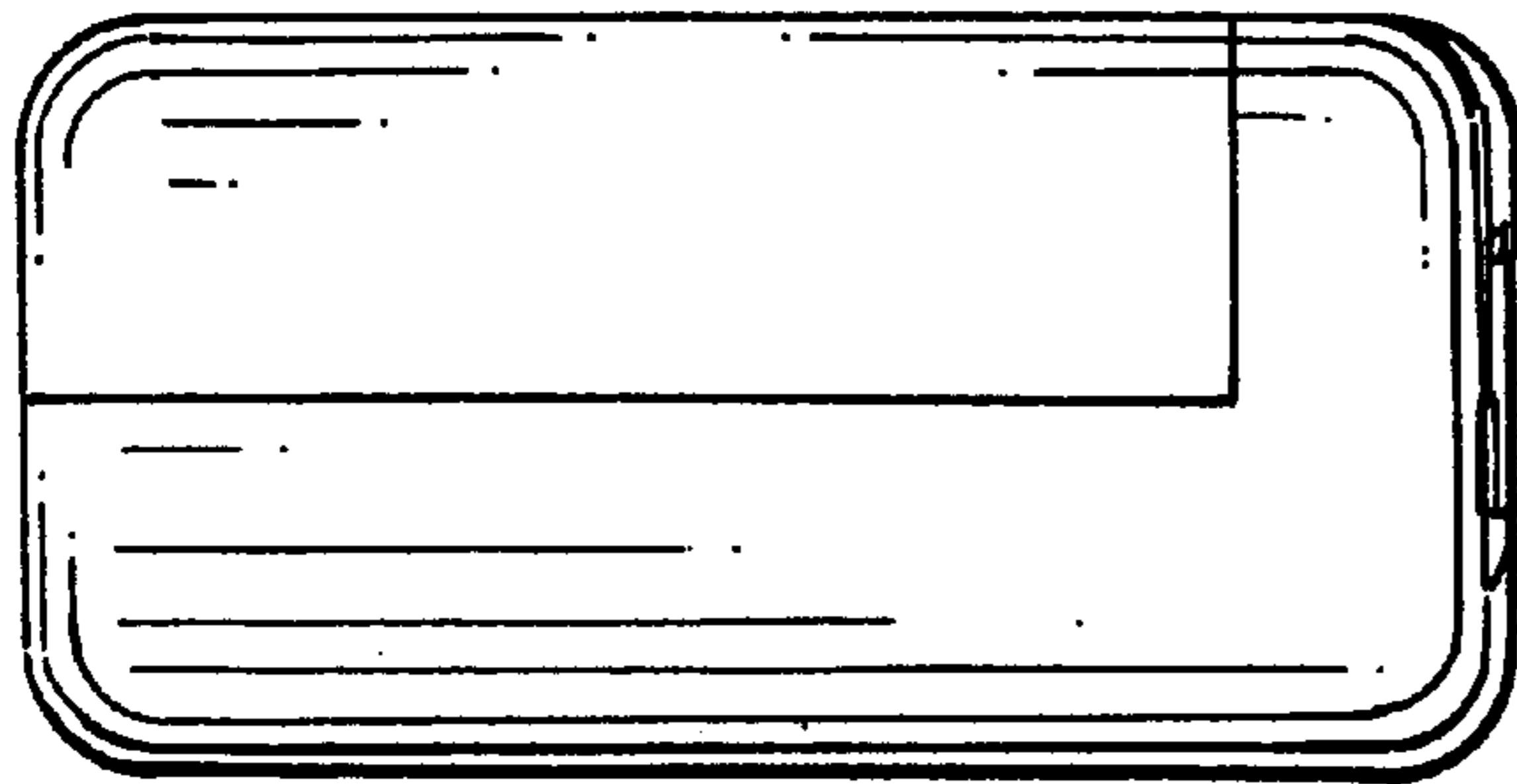

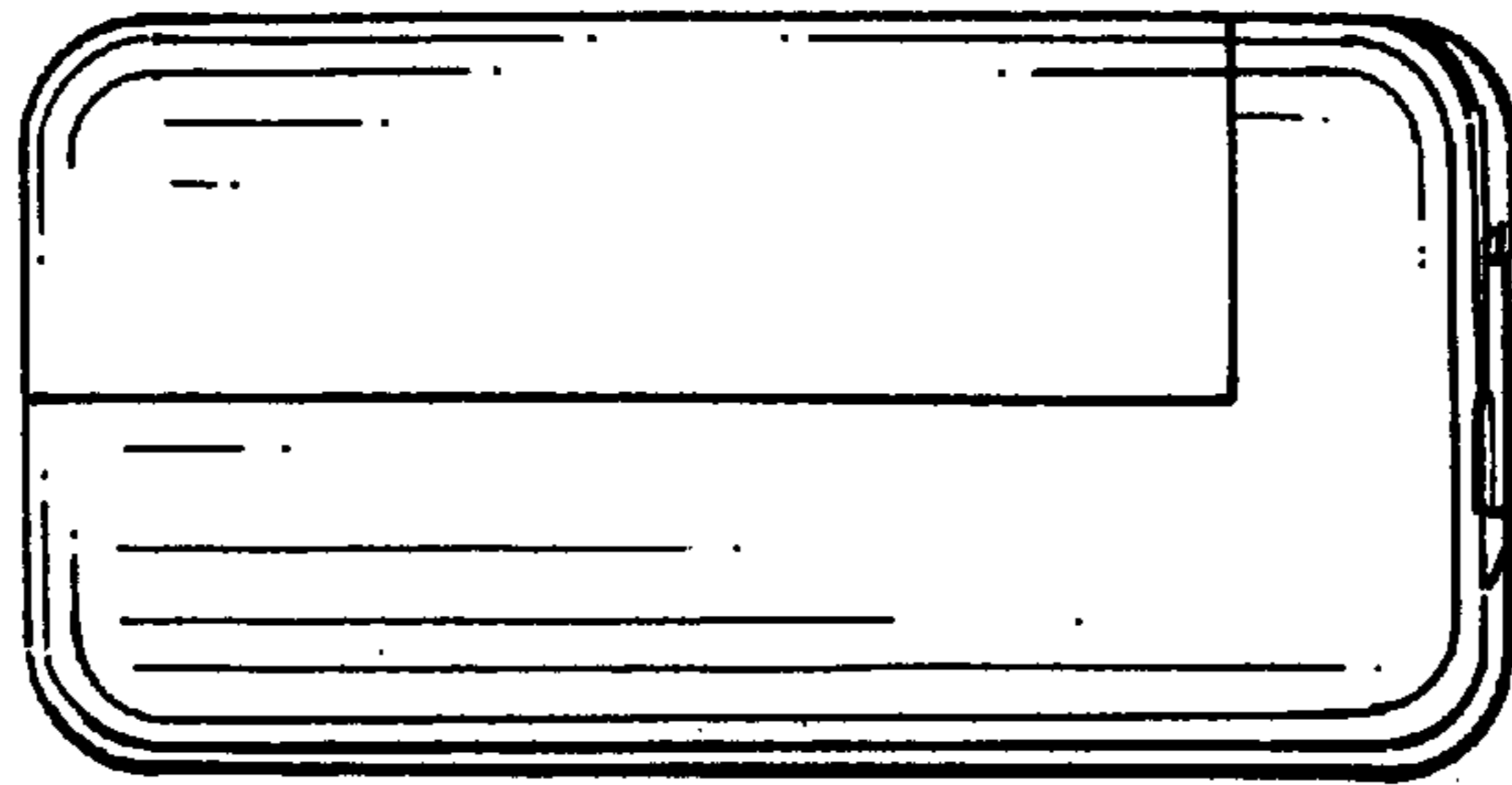

FIG. 1

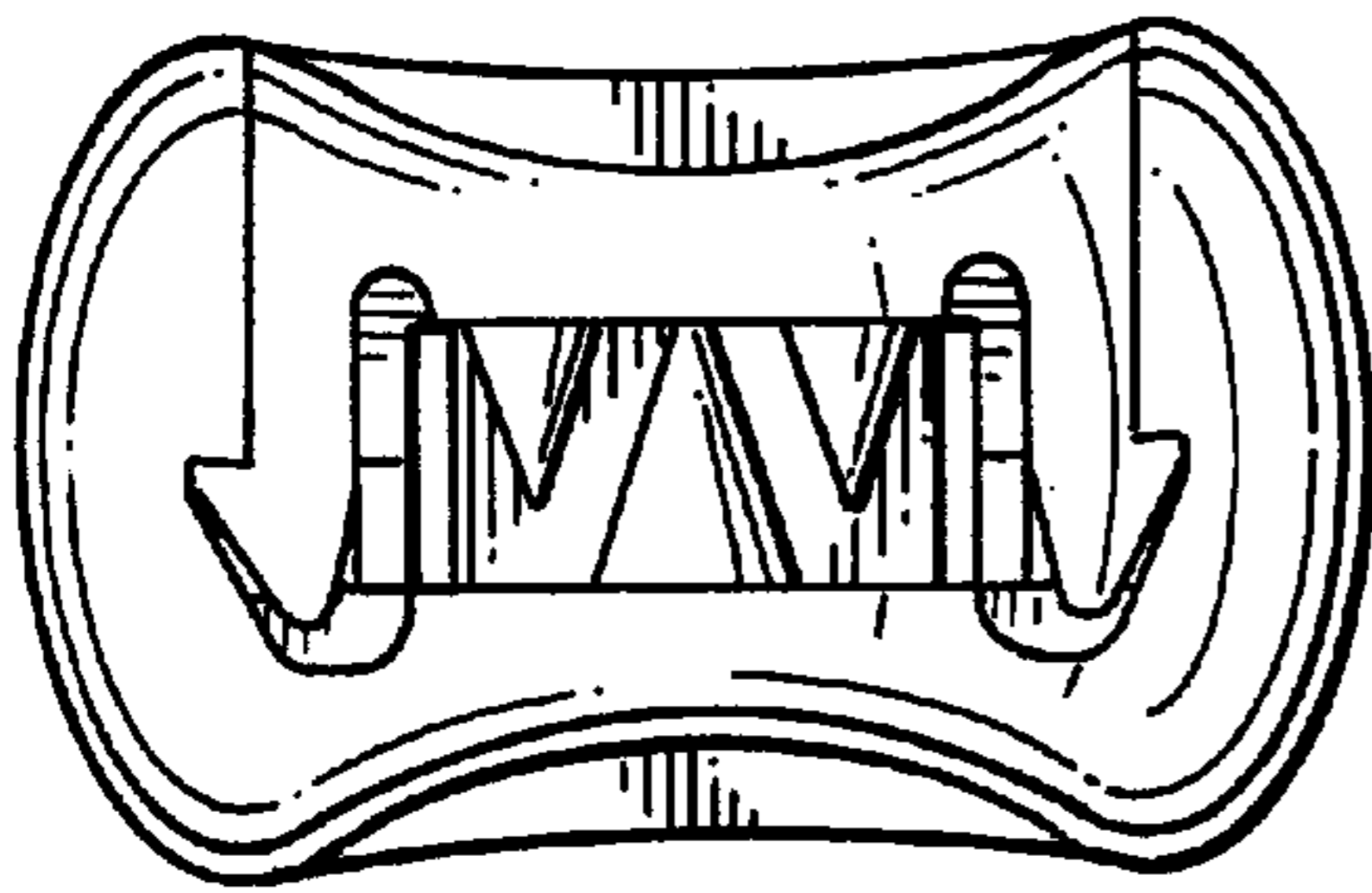

FIG. 2

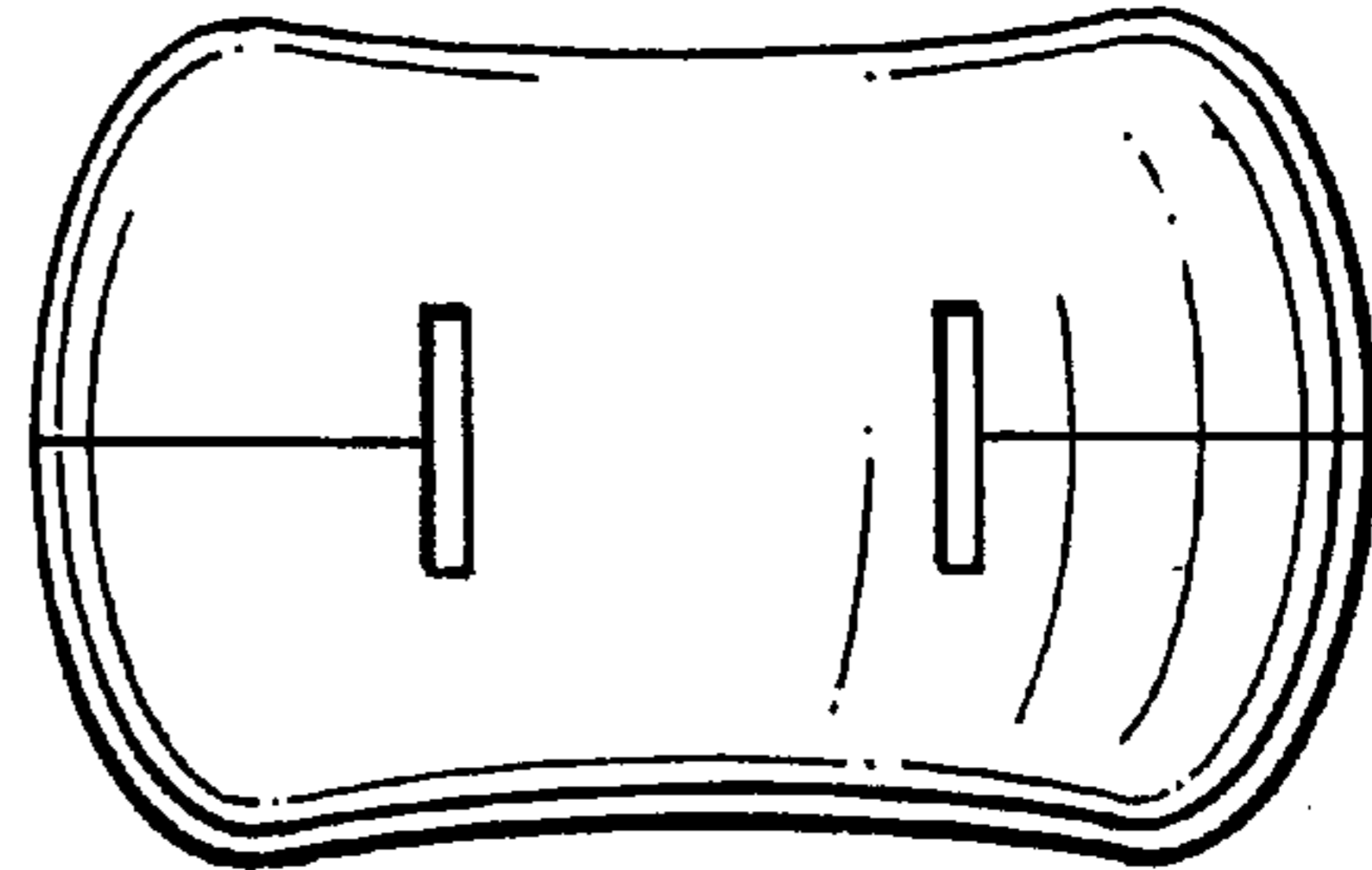

FIG. 3

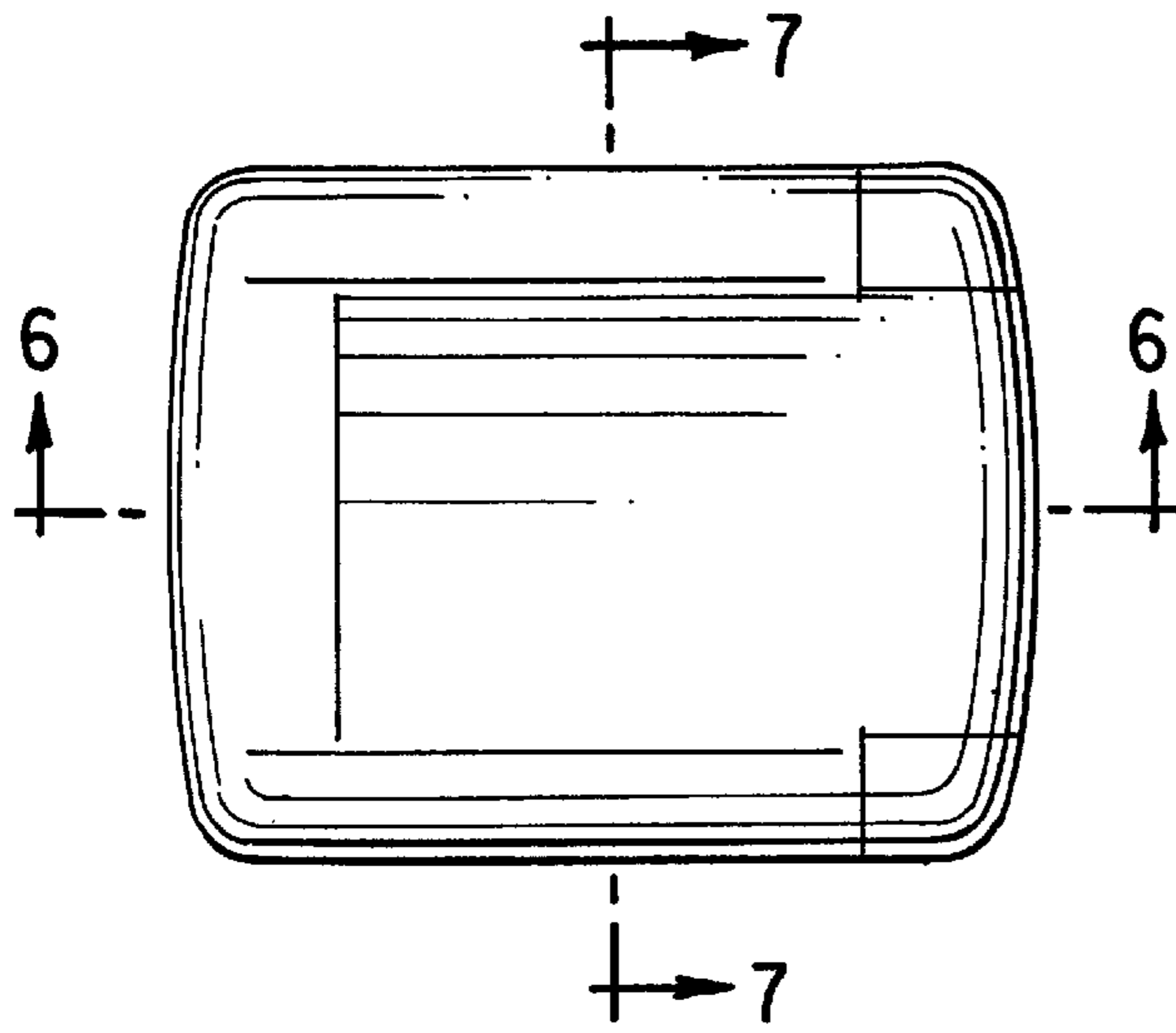

FIG. 4

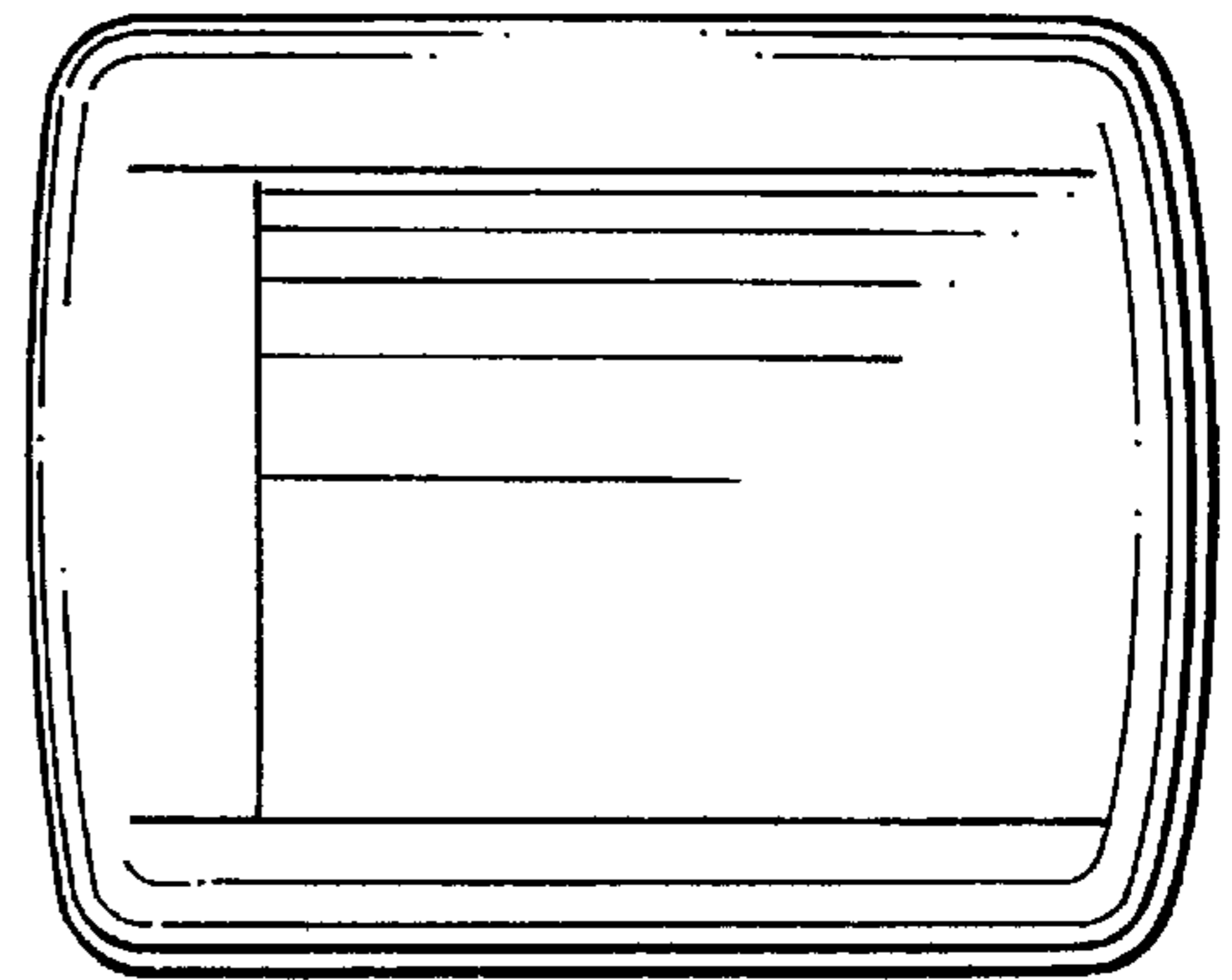

FIG. 5

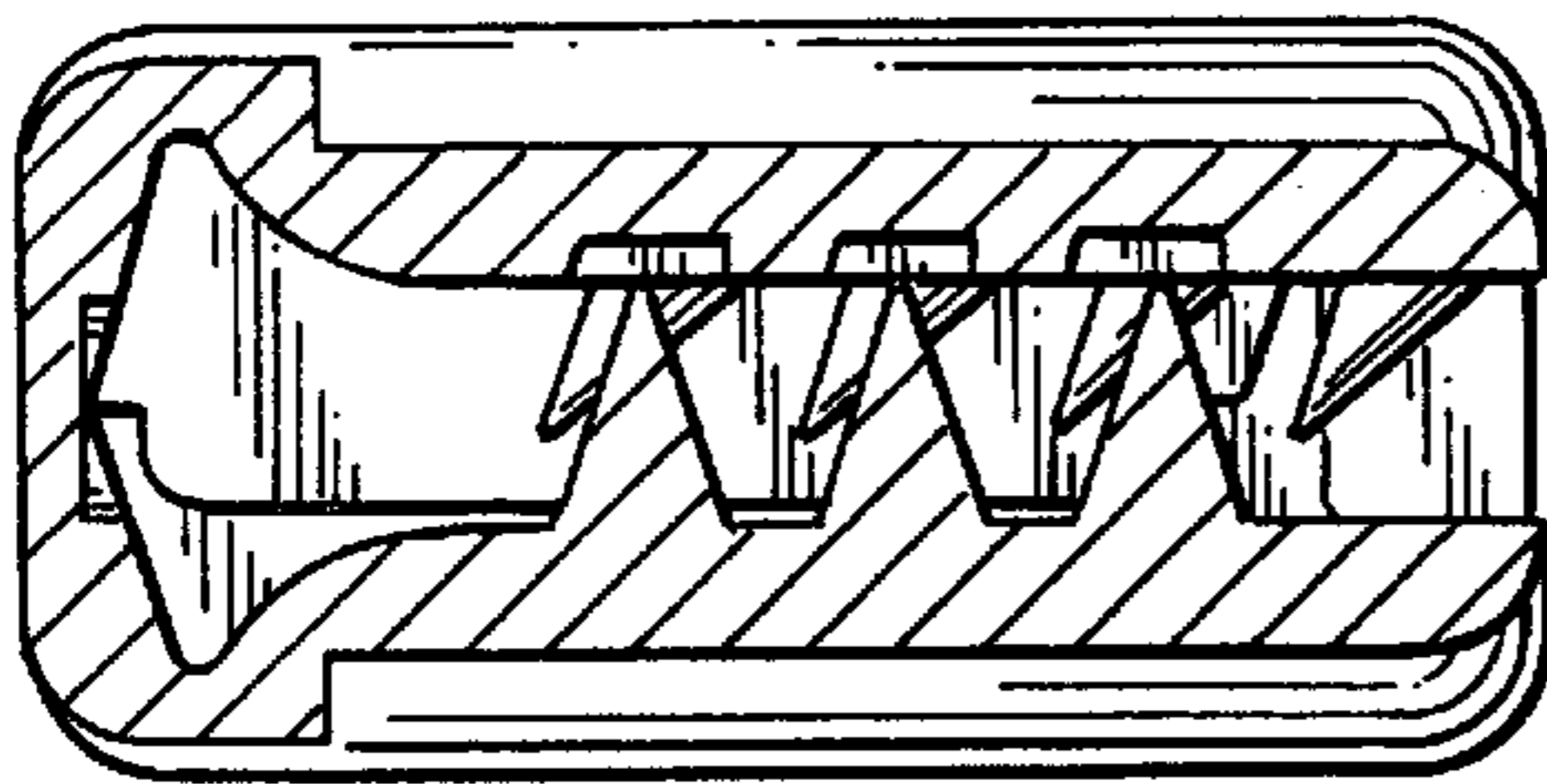

FIG. 6

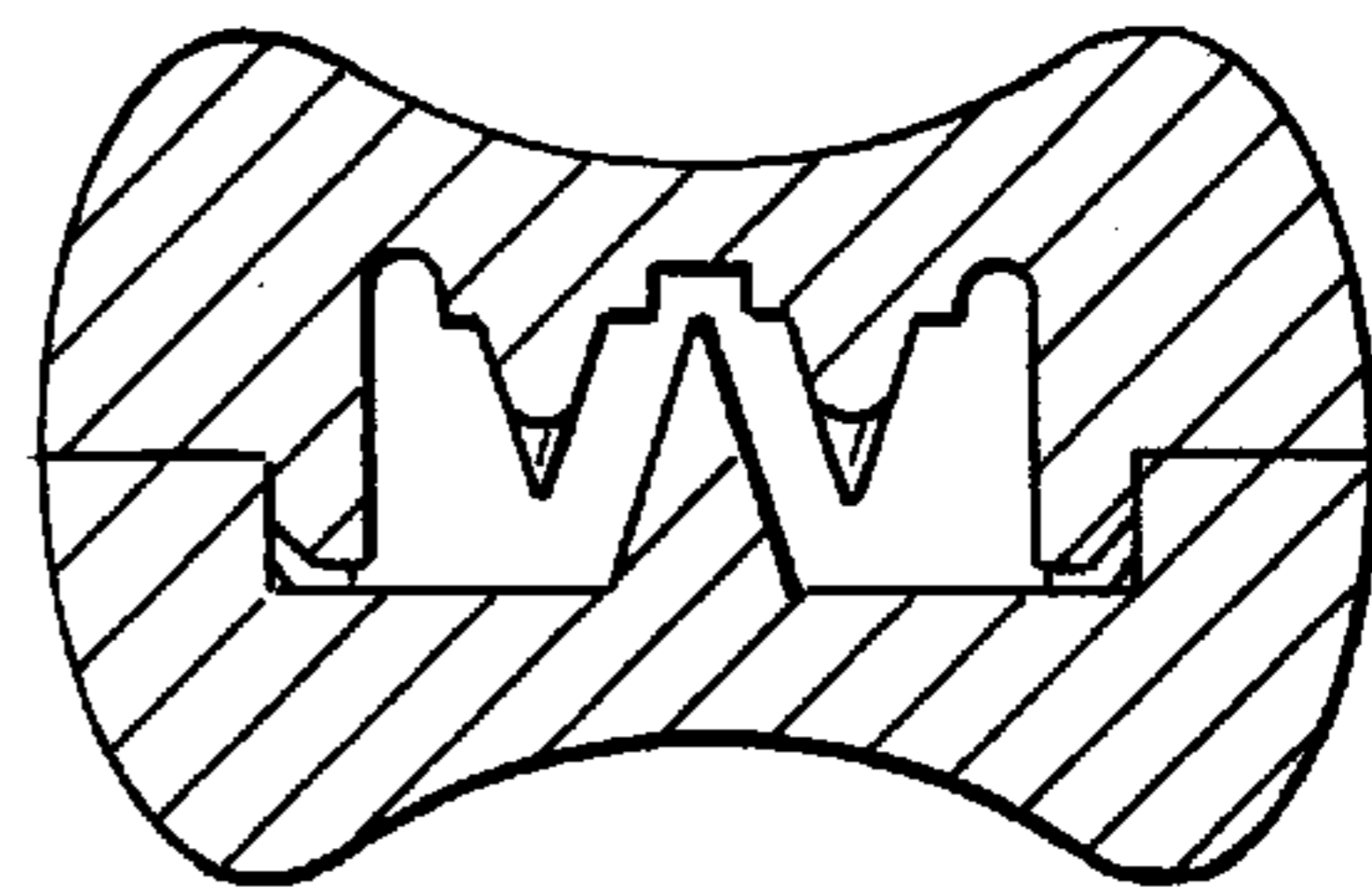

FIG. 7

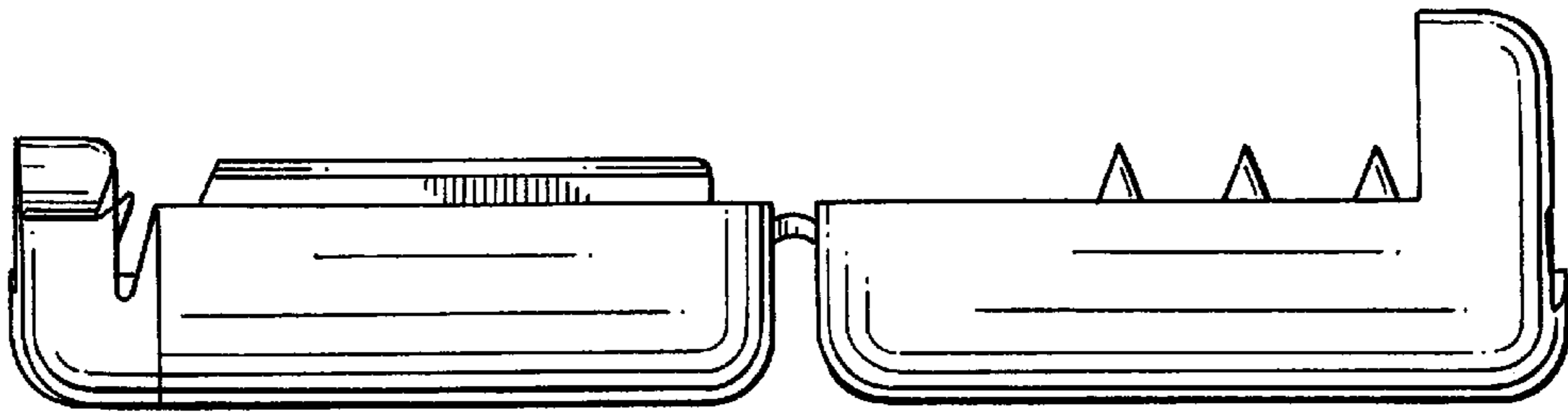

FIG. 8

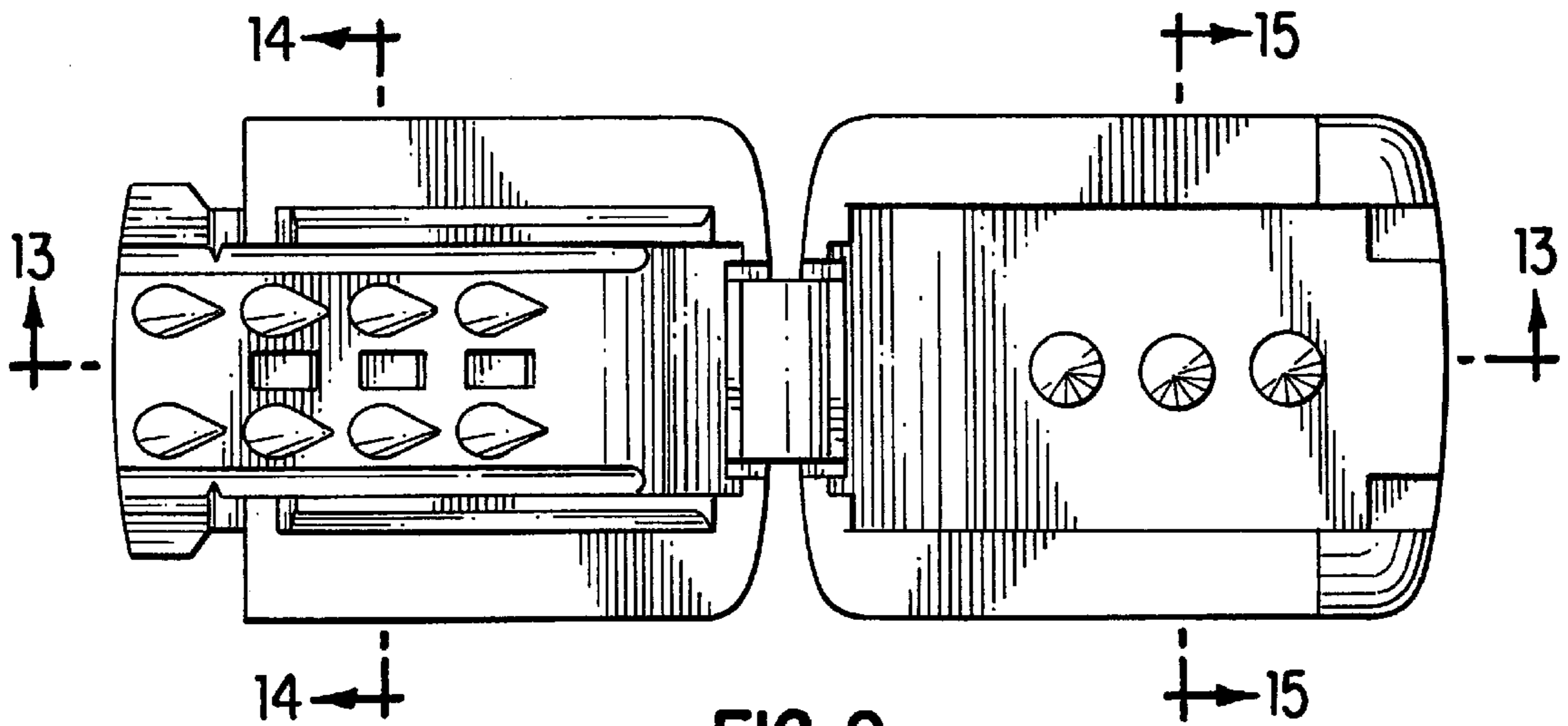

FIG. 9

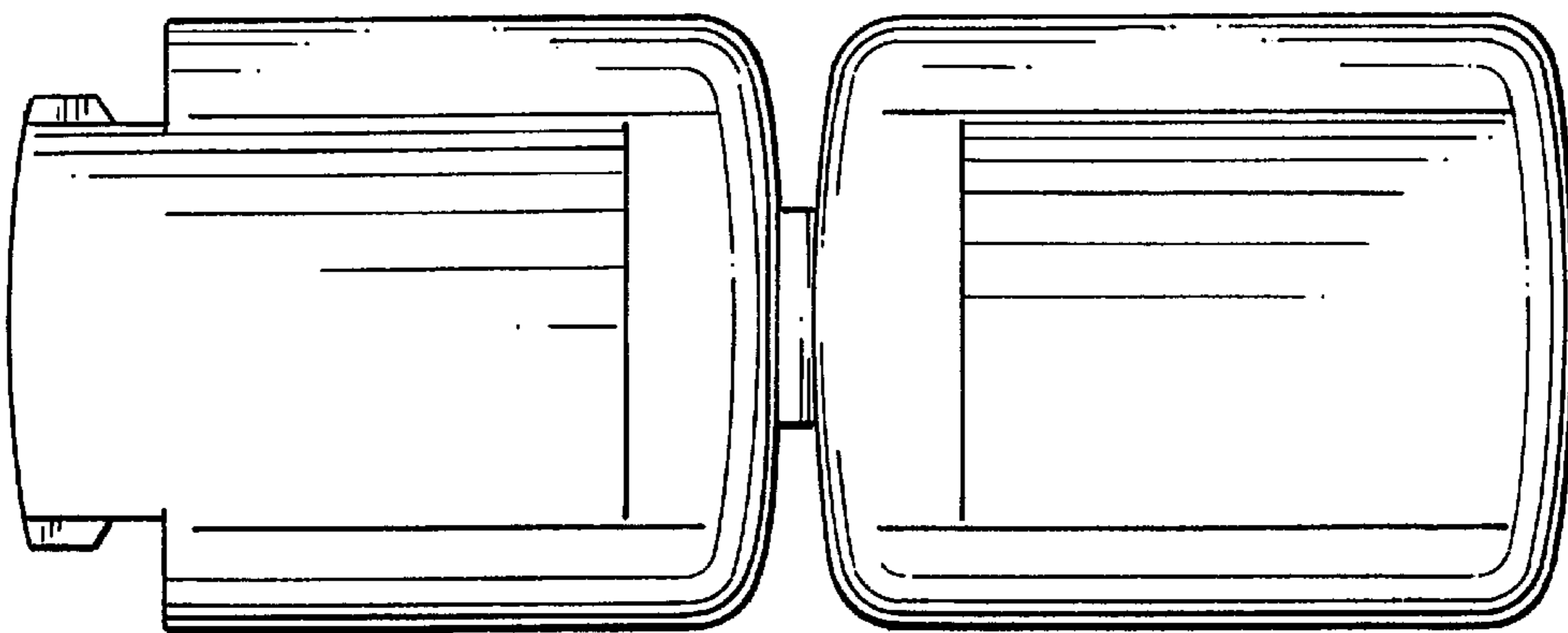

FIG. 10

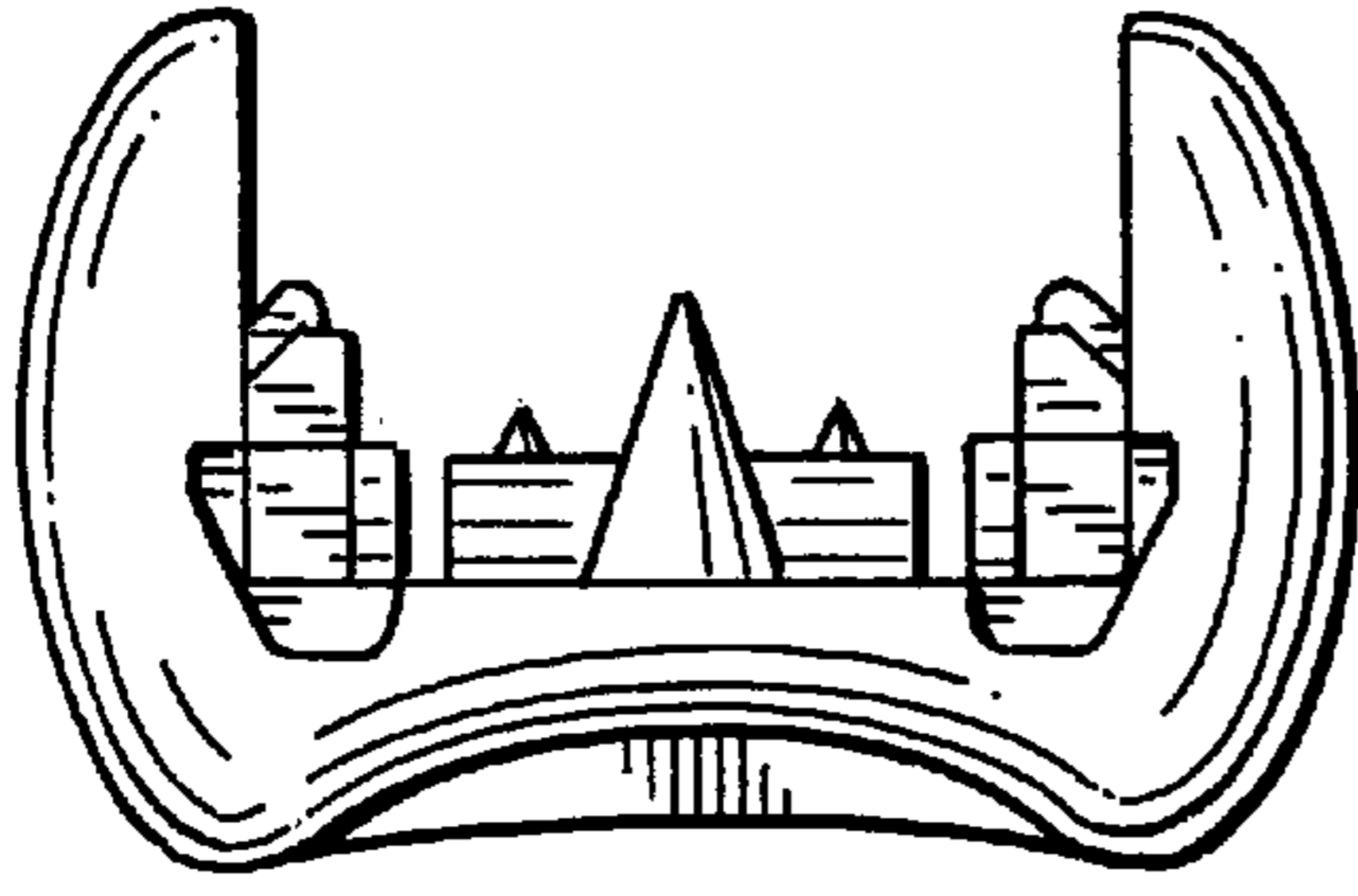

FIG. 11

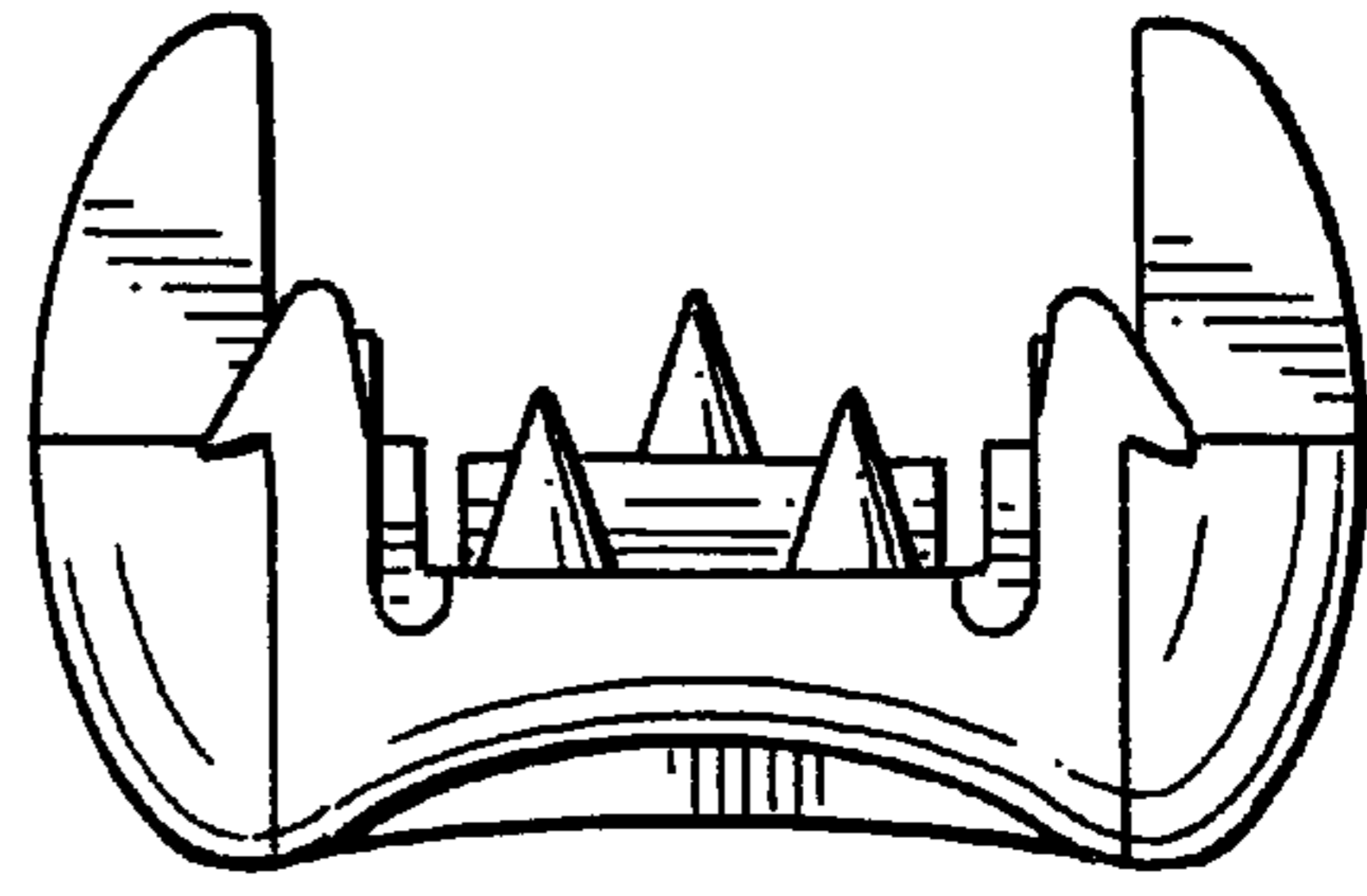

FIG. 12

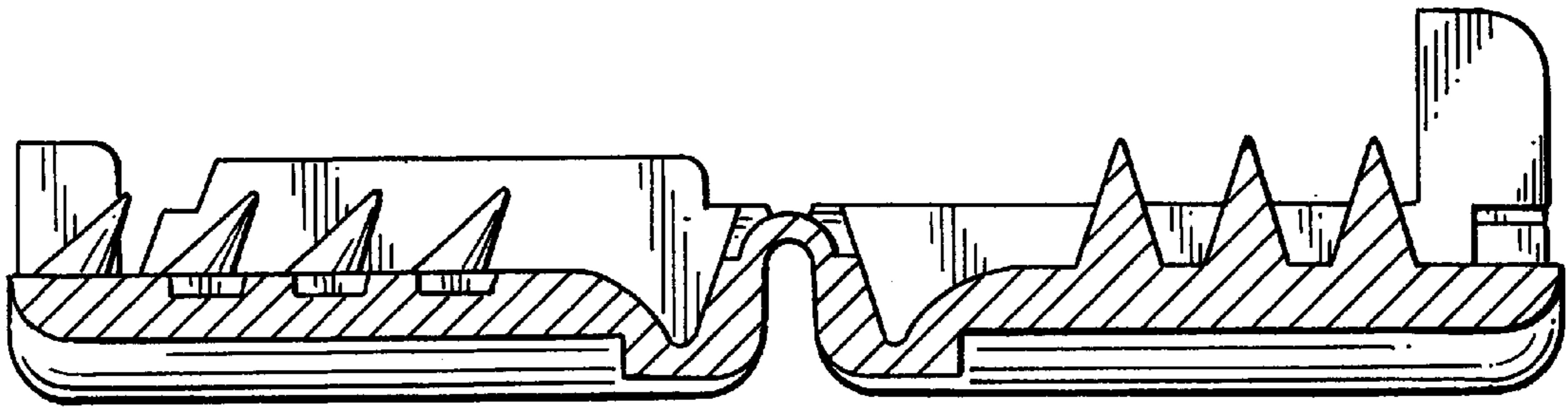

FIG. 13

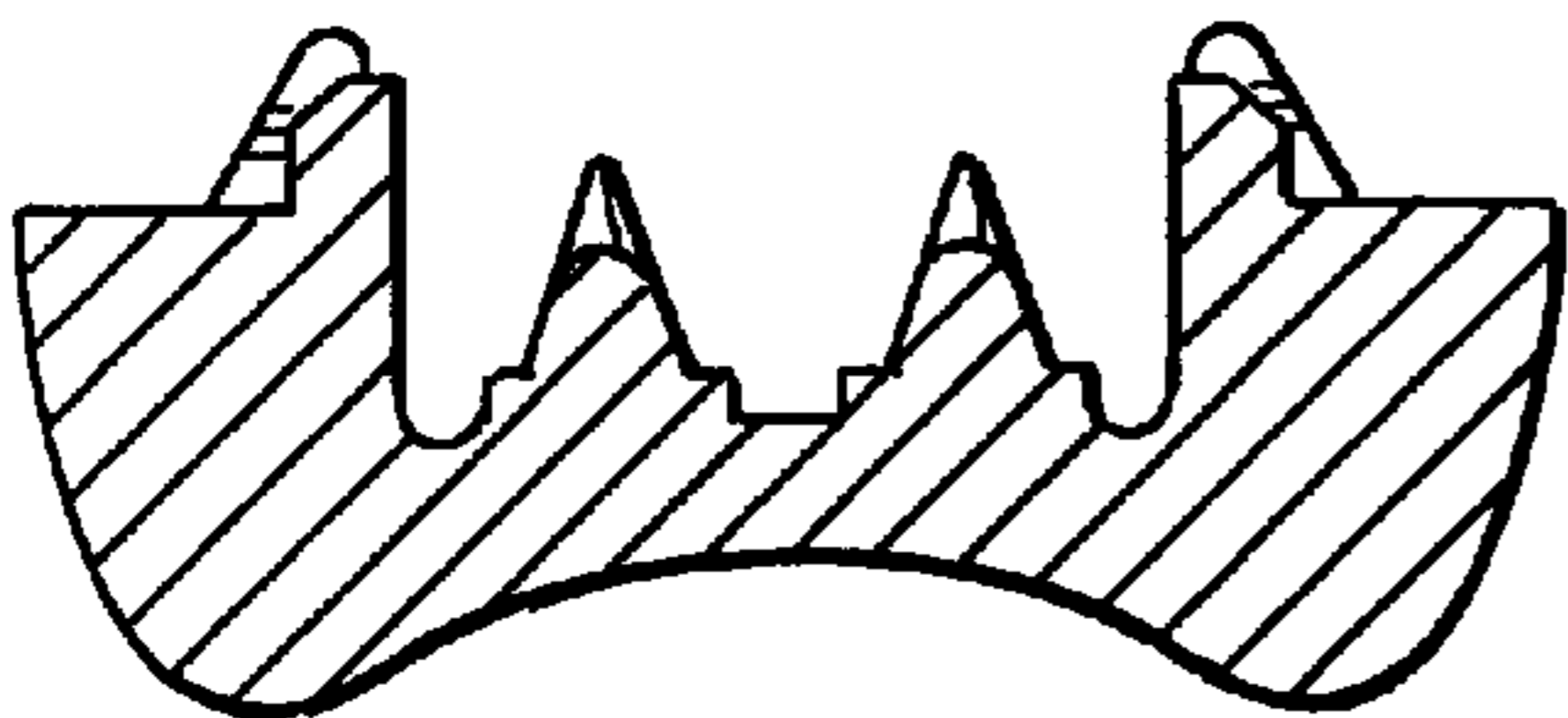

FIG. 14

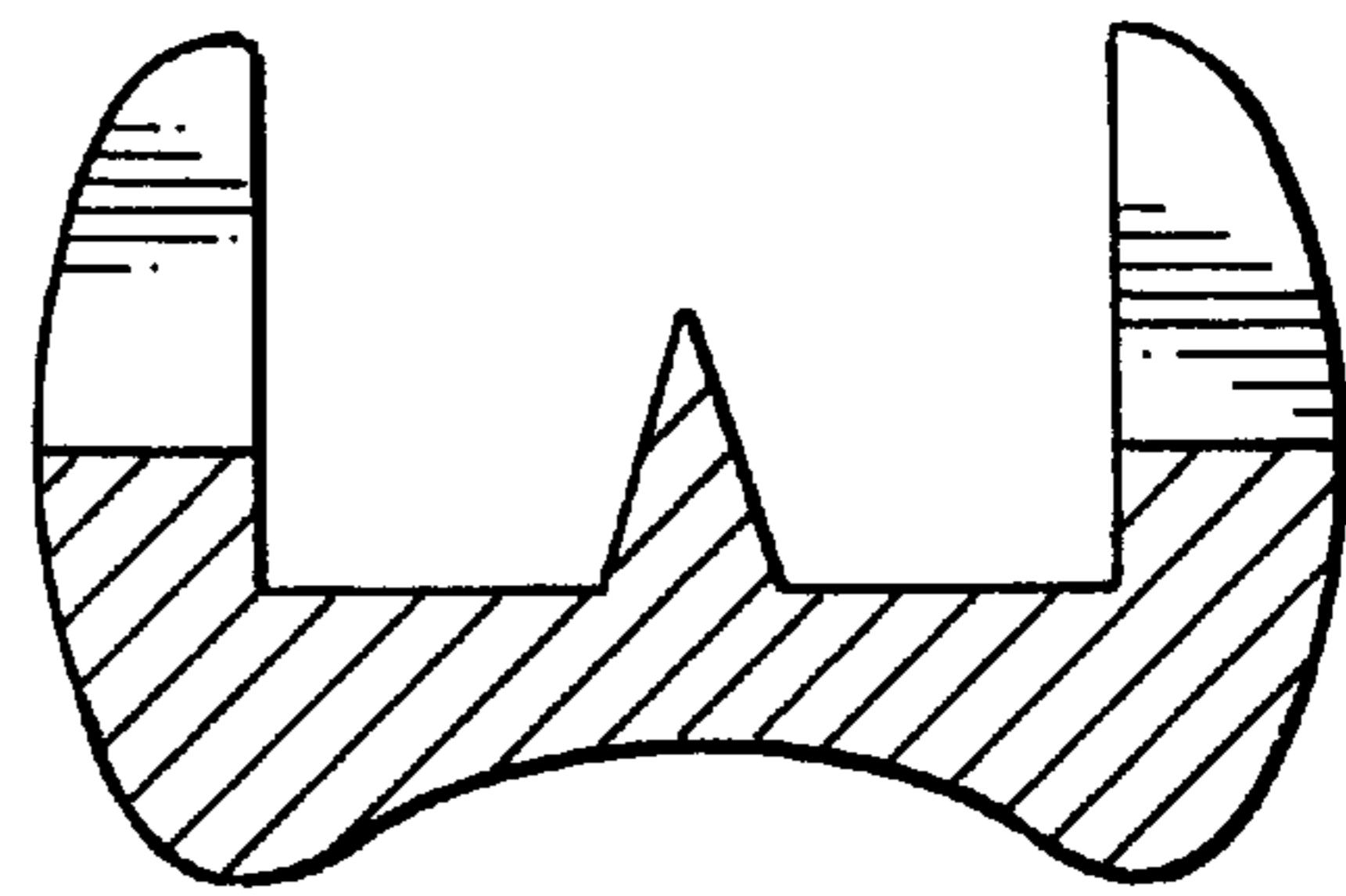

FIG. 15