



US00D442411S

(12) **United States Design Patent**
Warnelov

(10) **Patent No.:** **US D442,411 S**

(45) **Date of Patent:** **** May 22, 2001**

(54) **APPARATUS FOR KEY HANDLING**

(74) *Attorney, Agent, or Firm*—Davis & Bujold, P.L.L.C.

(76) Inventor: **Johnny Warnelov**, Sodergatan 39,
S-573 39 Tranas (SE)

(57) **CLAIM**

The ornamental design for an apparatus for key handling, as shown and described.

(**) Term: **14 Years**

DESCRIPTION

(21) Appl. No.: **29/119,945**

FIG. 1 is a top, front, and left side perspective view of an apparatus for key handling showing my new design;

(22) Filed: **Mar. 10, 2000**

FIG. 2 is a front elevational view thereof;

(30) **Foreign Application Priority Data**

FIG. 3 is a top, front, and left side perspective view of the holder portion thereof;

Sep. 15, 1999 (DK) MA 1999 1078

FIG. 4 is a front elevational view of the holder portion thereof;

(51) **LOC (7) Cl.** **06-04**

FIG. 5 is a rear elevational view of the holder portion thereof;

(52) **U.S. Cl.** **D6/567**

FIG. 6 is an enlarged bottom plan view thereof;

(58) **Field of Search** D6/512, 513, 553,
D6/567; 211/13.1, 70.1, 86.01, 87.01, 106.01;
248/307, 309.1, 309.2

FIG. 7 is an enlarged perspective view of the key identification portion thereof;

(56) **References Cited**

FIG. 8 is a front elevational view of the key identification portion thereof, the rear being identical in appearance;

U.S. PATENT DOCUMENTS

- D. 270,023 * 8/1983 Sheldon D6/566
- D. 331,855 * 12/1992 Kaplan D6/512
- D. 364,769 * 12/1995 Hickman D6/567
- 4,326,761 * 4/1982 Schwartz 211/88.01 X
- 5,377,820 * 1/1995 Christman 211/13.1 X

FIG. 9 is an end elevational view of the key identification portion thereof;

* cited by examiner

FIG. 10 is an opposite end elevational view of the key identification portion thereof; and,

FIG. 11 is a top plan view of the key identification portion thereof.

Primary Examiner—Brian N. Vinson

1 Claim, 8 Drawing Sheets

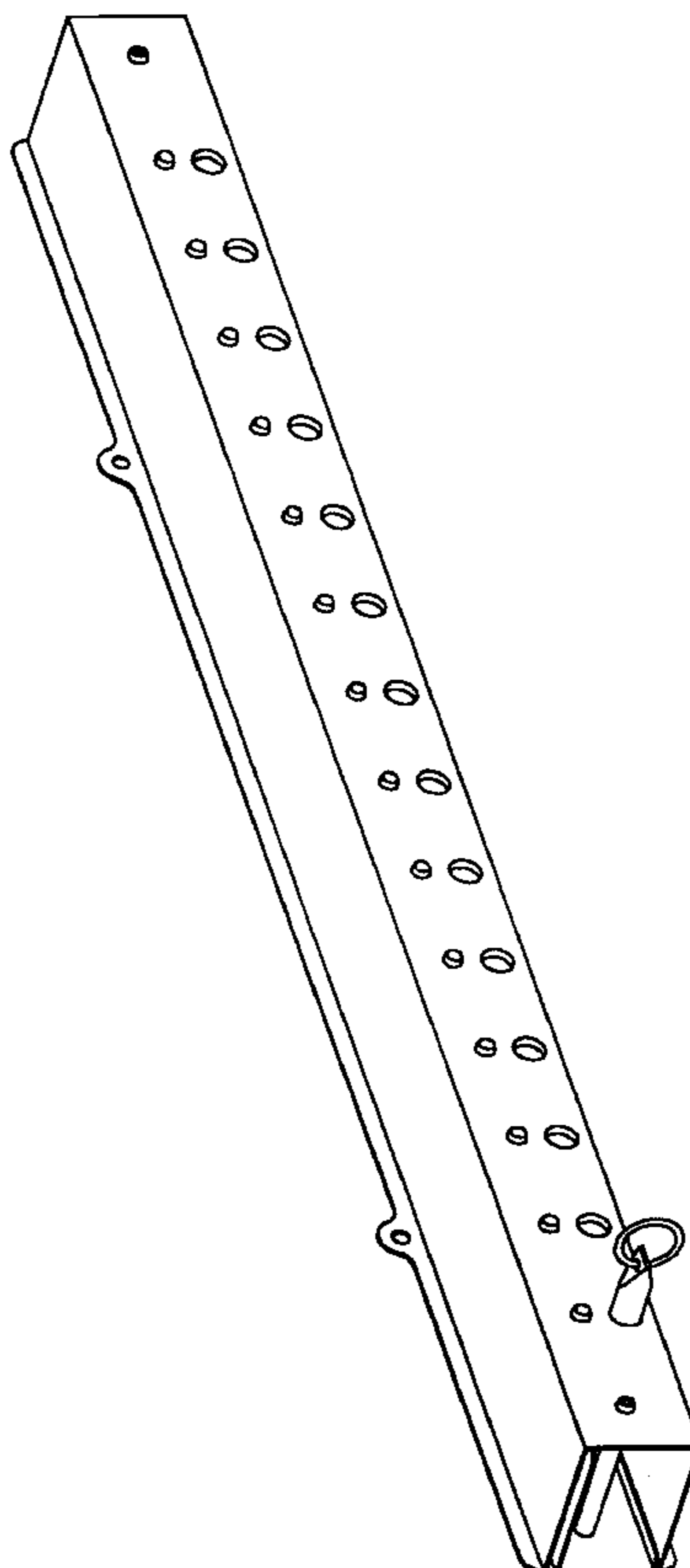

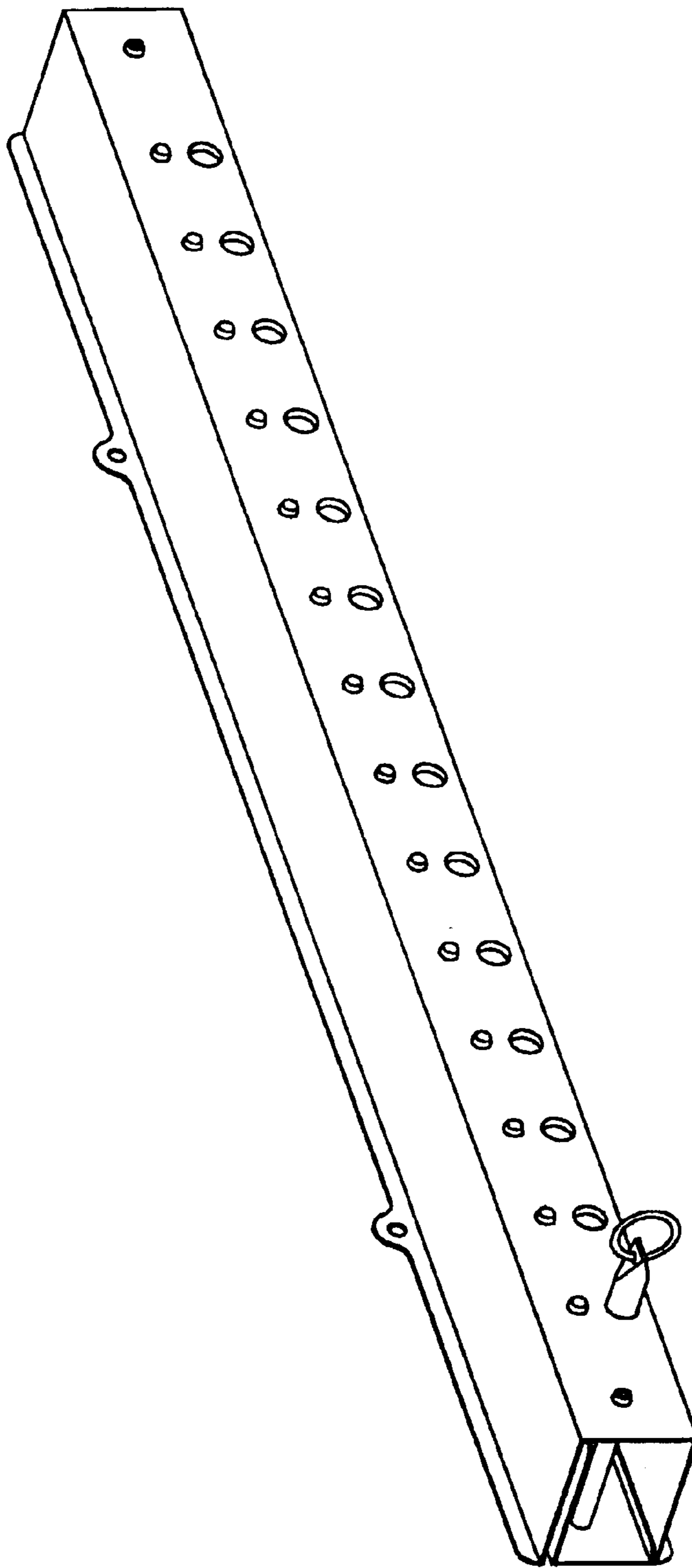

FIG. 1

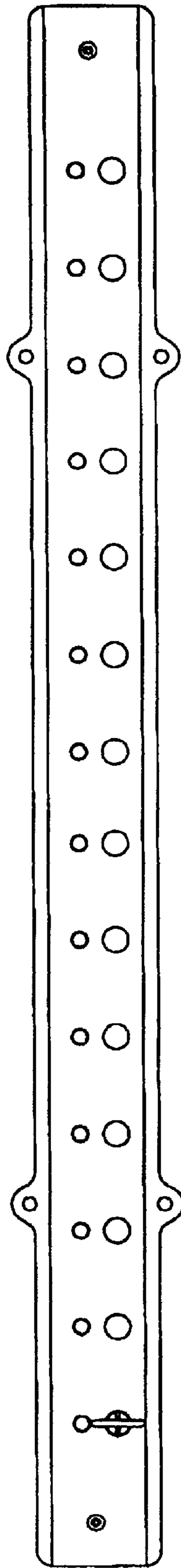

FIG. 2

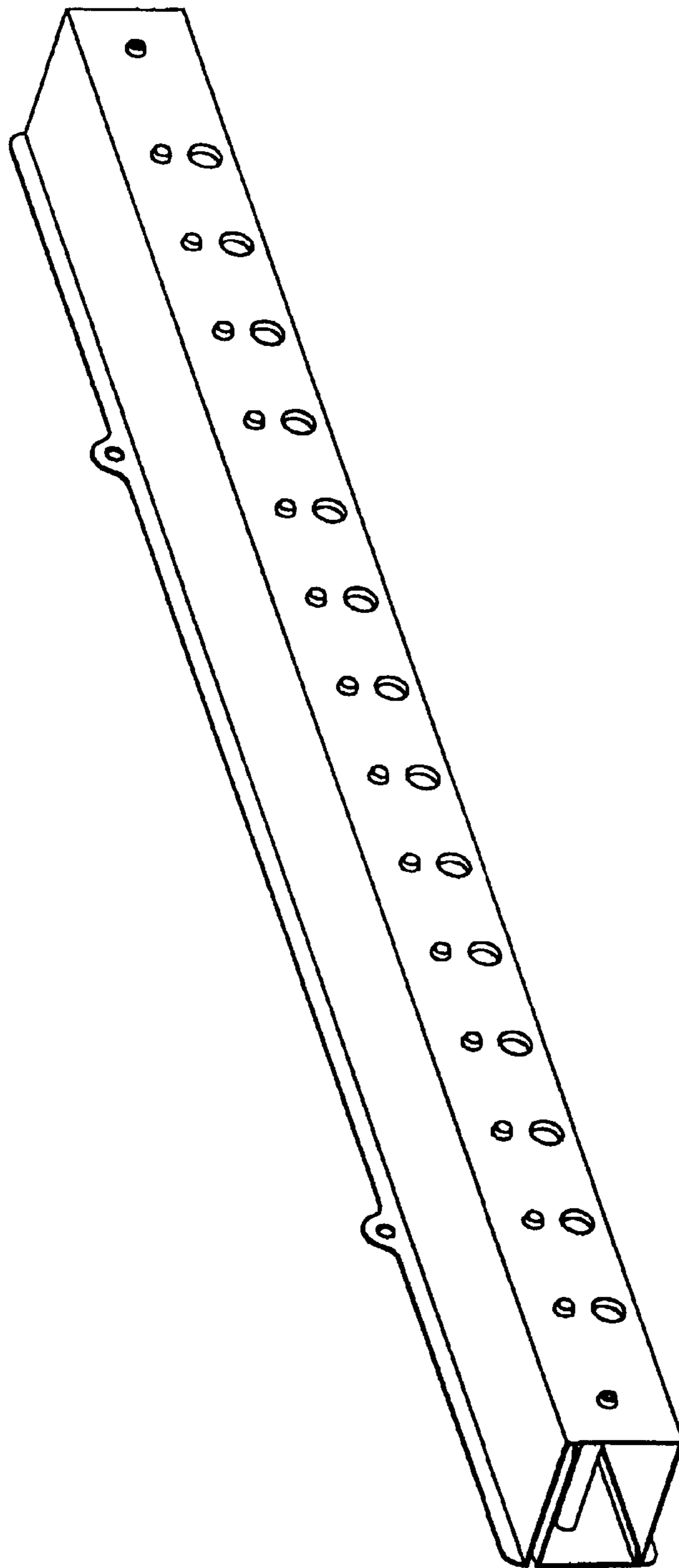

FIG. 3

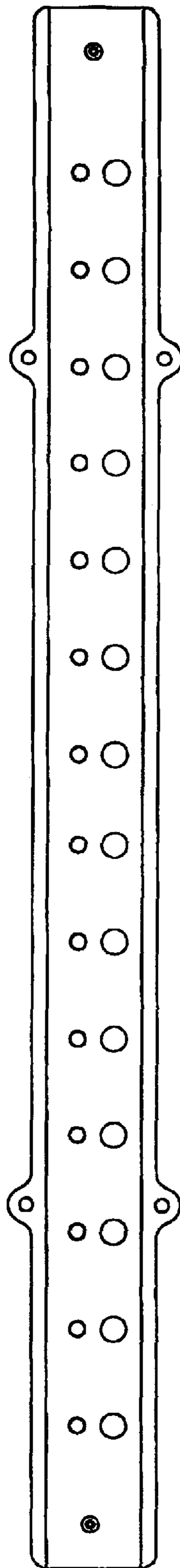

FIG. 4

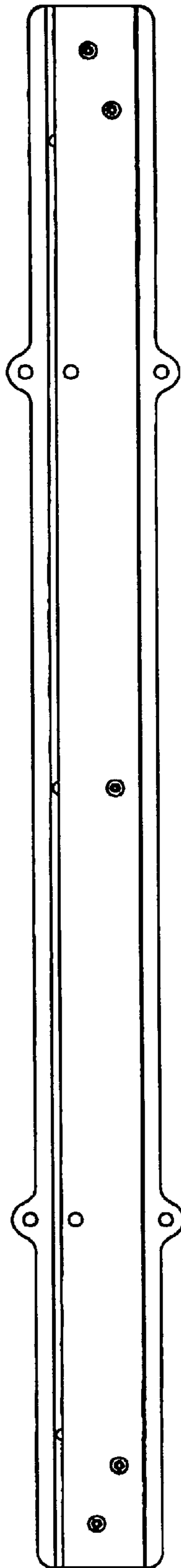

FIG. 5

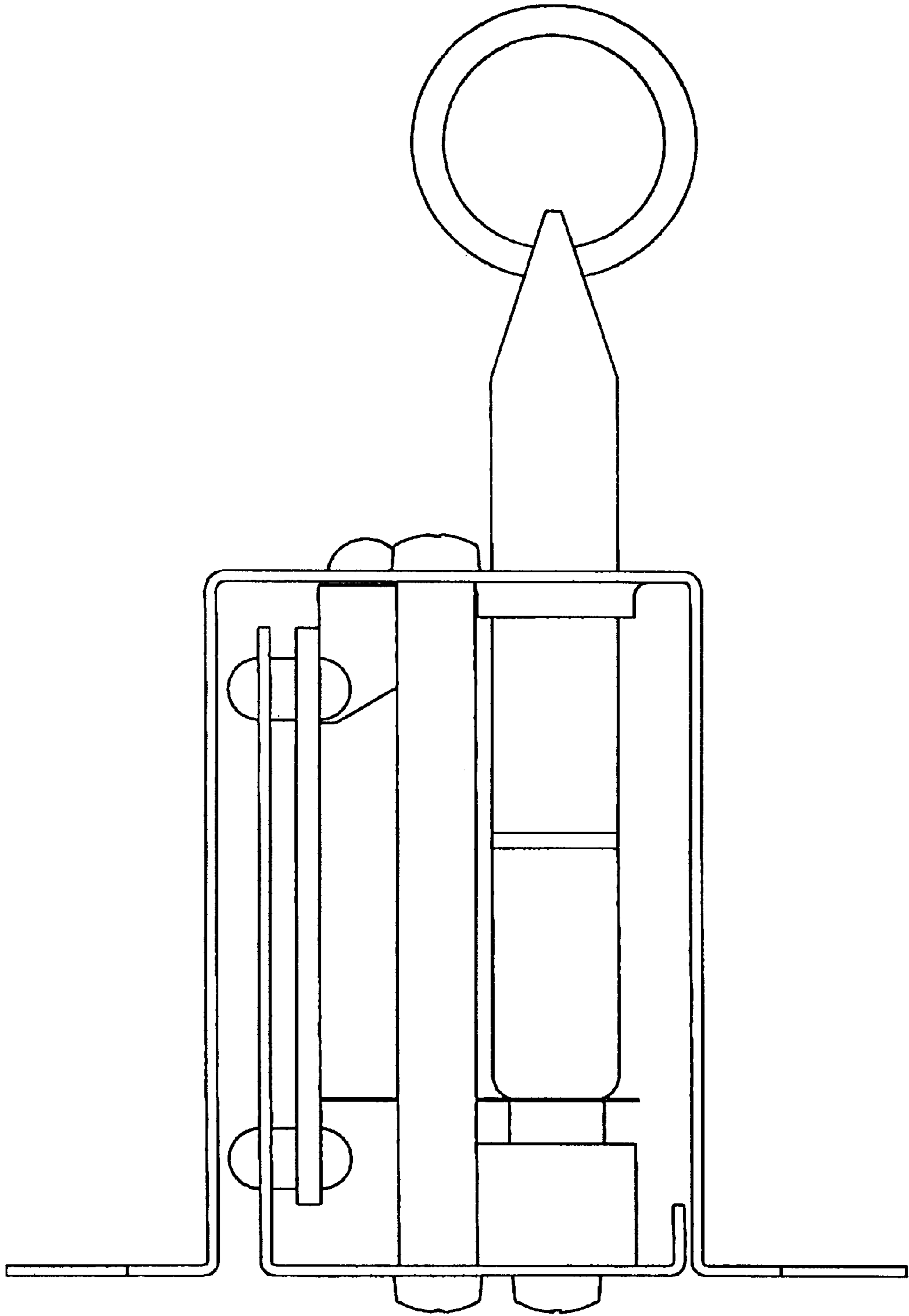

FIG. 6

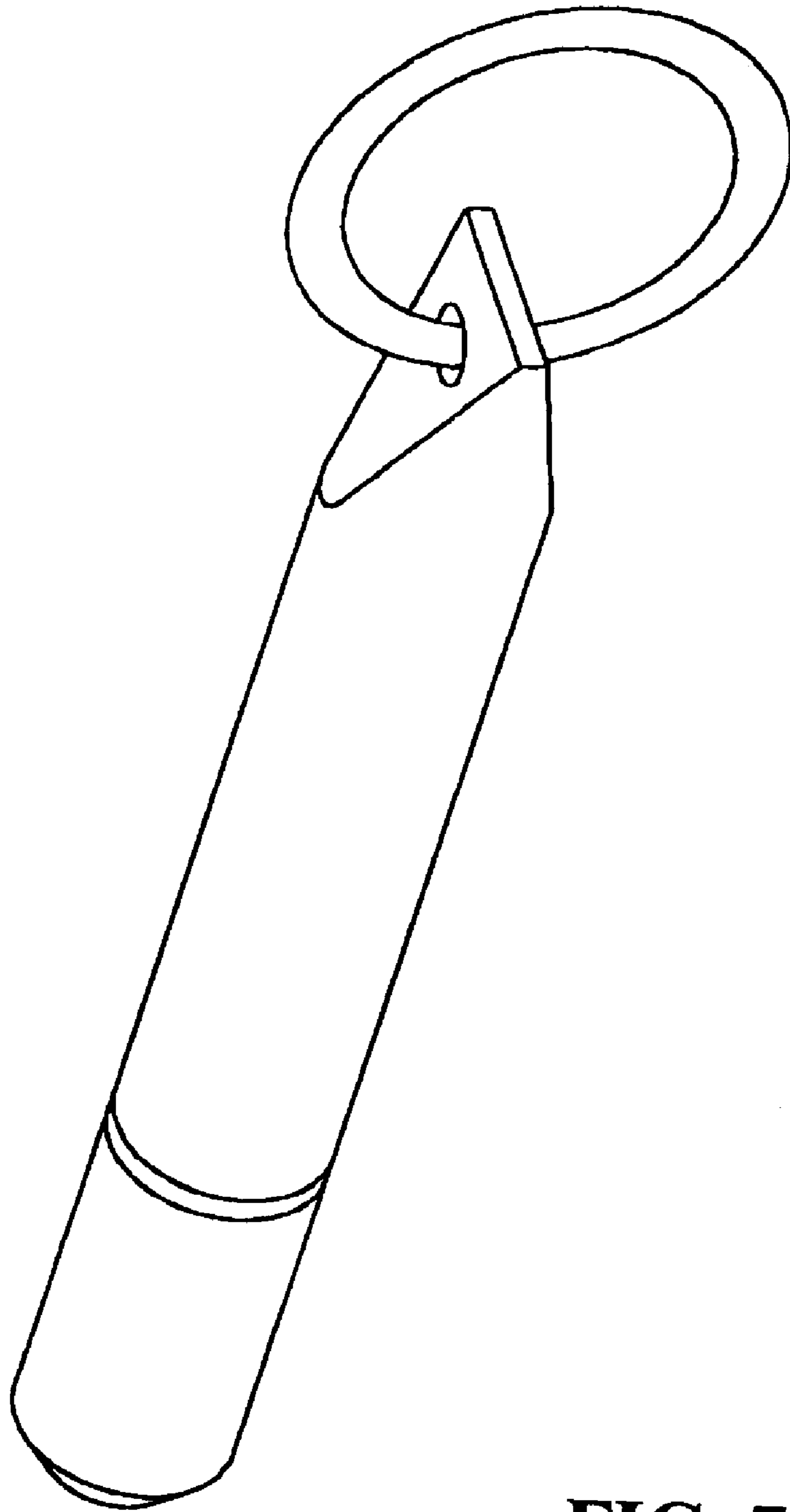

FIG. 7

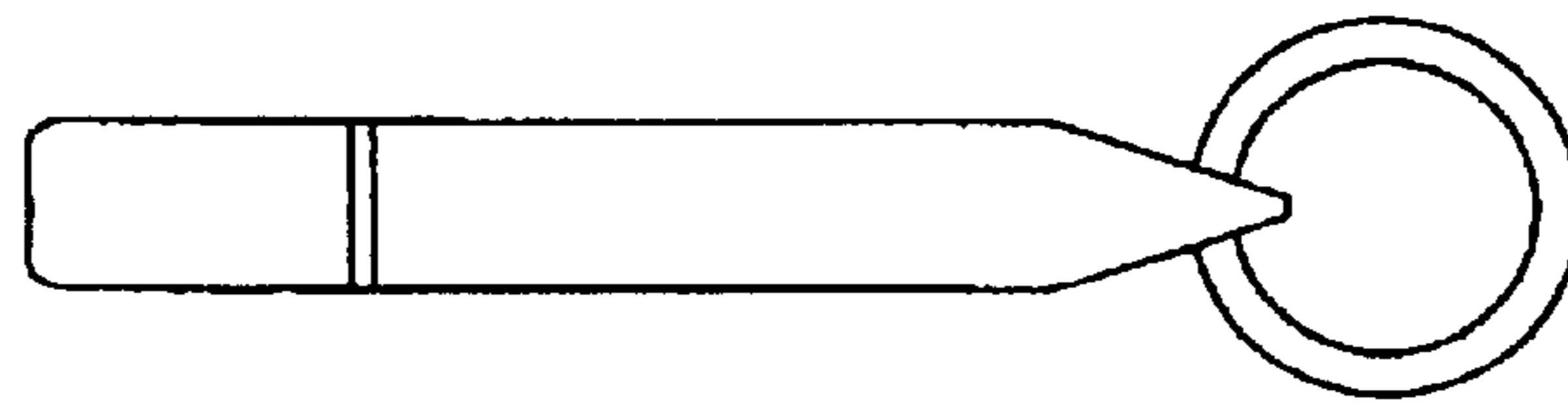

FIG. 8

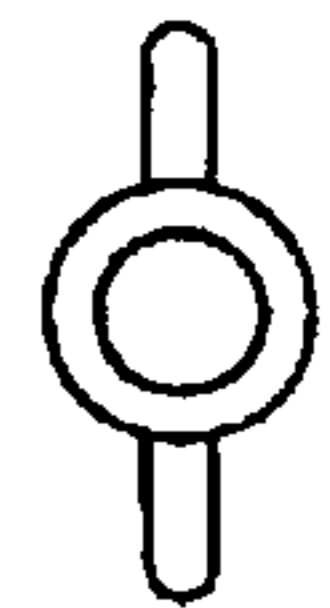

FIG. 9



FIG. 10

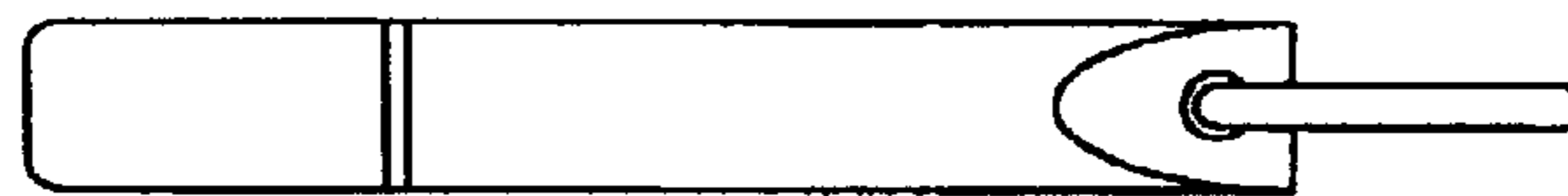

FIG. 11