



US00D442297S

(12) **United States Design Patent**
Kulik

(10) **Patent No.:** **US D442,297 S**

(45) **Date of Patent:** **** May 15, 2001**

(54) **BUILDING PANEL**

(75) Inventor: **Magnus Kulik**, Vellinge (SE)

(73) Assignee: **Pergo, AB**, Trelleborg (SE)

(**) Term: **14 Years**

(21) Appl. No.: **29/125,701**

(22) Filed: **Jun. 29, 2000**

(51) **LOC (7) Cl.** **25-01**

(52) **U.S. Cl.** **D25/138**

(58) **Field of Search** D25/138; 52/578,
52/588.1, 586.1, 586.2, 782.1, 783.1

(56) **References Cited**

U.S. PATENT DOCUMENTS

D. 272,767	*	2/1984	Nemeth	D25/138
1,955,515	*	4/1934	Reed	52/783.1
2,283,582	*	5/1942	Scherer	52/783.1

* cited by examiner

Primary Examiner—Doris Clark

(74) *Attorney, Agent, or Firm*—Stevens, Davis, Miller & Mosher, L.L.P.

(57) **CLAIM**

The ornamental design for a building panel, as shown and described.

DESCRIPTION

FIG. 1 is a top plan view of the building panel according the present invention;

FIG. 2 is an end view of the building panel of FIG. 1 along arrow 2;

FIG. 3 is a side view of the building panel of FIG. 1 along arrow 3;

FIG. 4 is an end view of the building panel of FIG. 1 along arrow 4;

FIG. 5 is a side view of the building panel of FIG. 1 along arrow 5;

FIG. 6 is an enlarged top view of the building panel of FIG. 1; and,

FIG. 7 is an enlarged bottom view of the building panel of FIG. 1.

The building panel is broken in the center indicating indeterminate length.

1 Claim, 3 Drawing Sheets

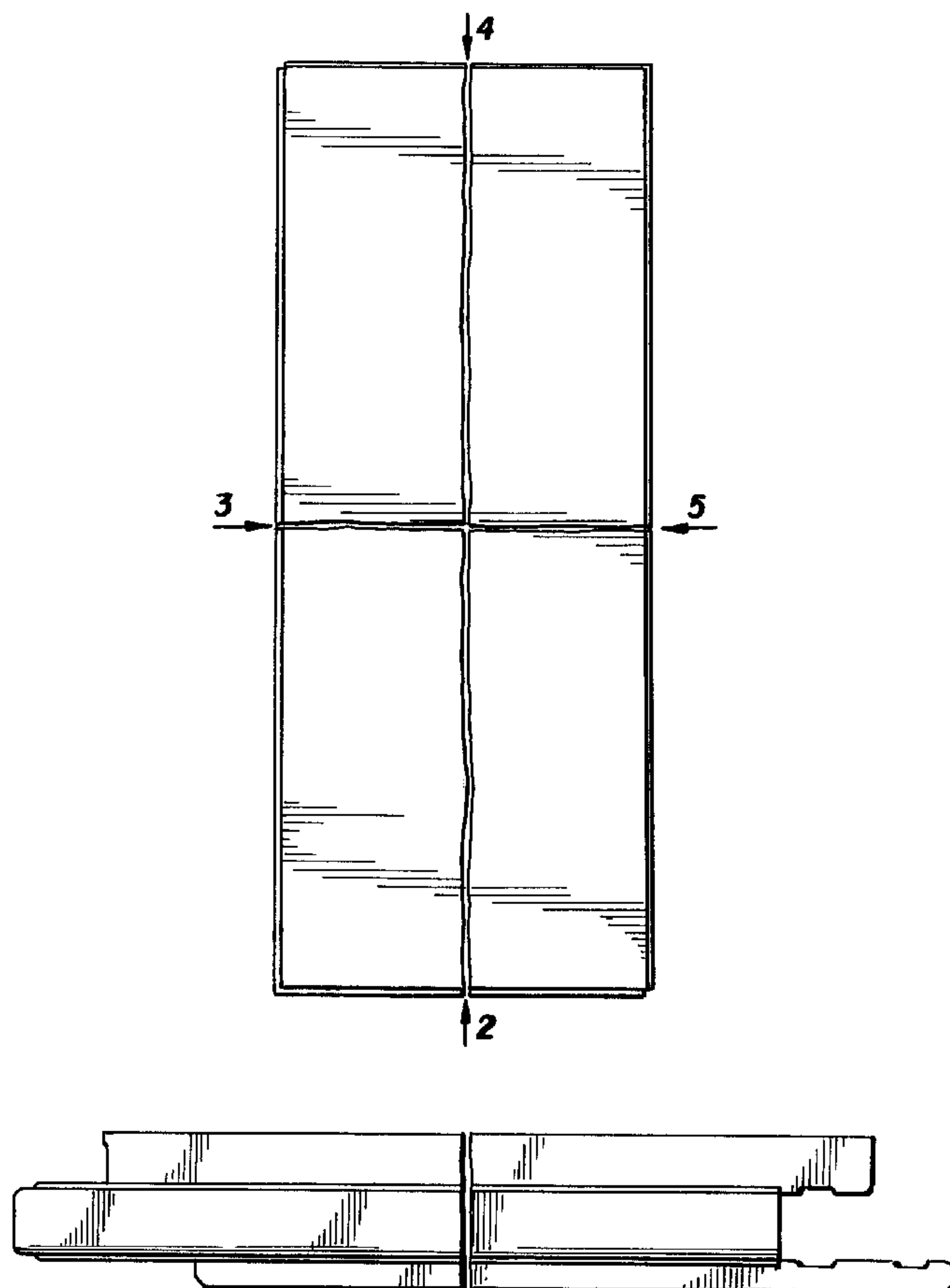

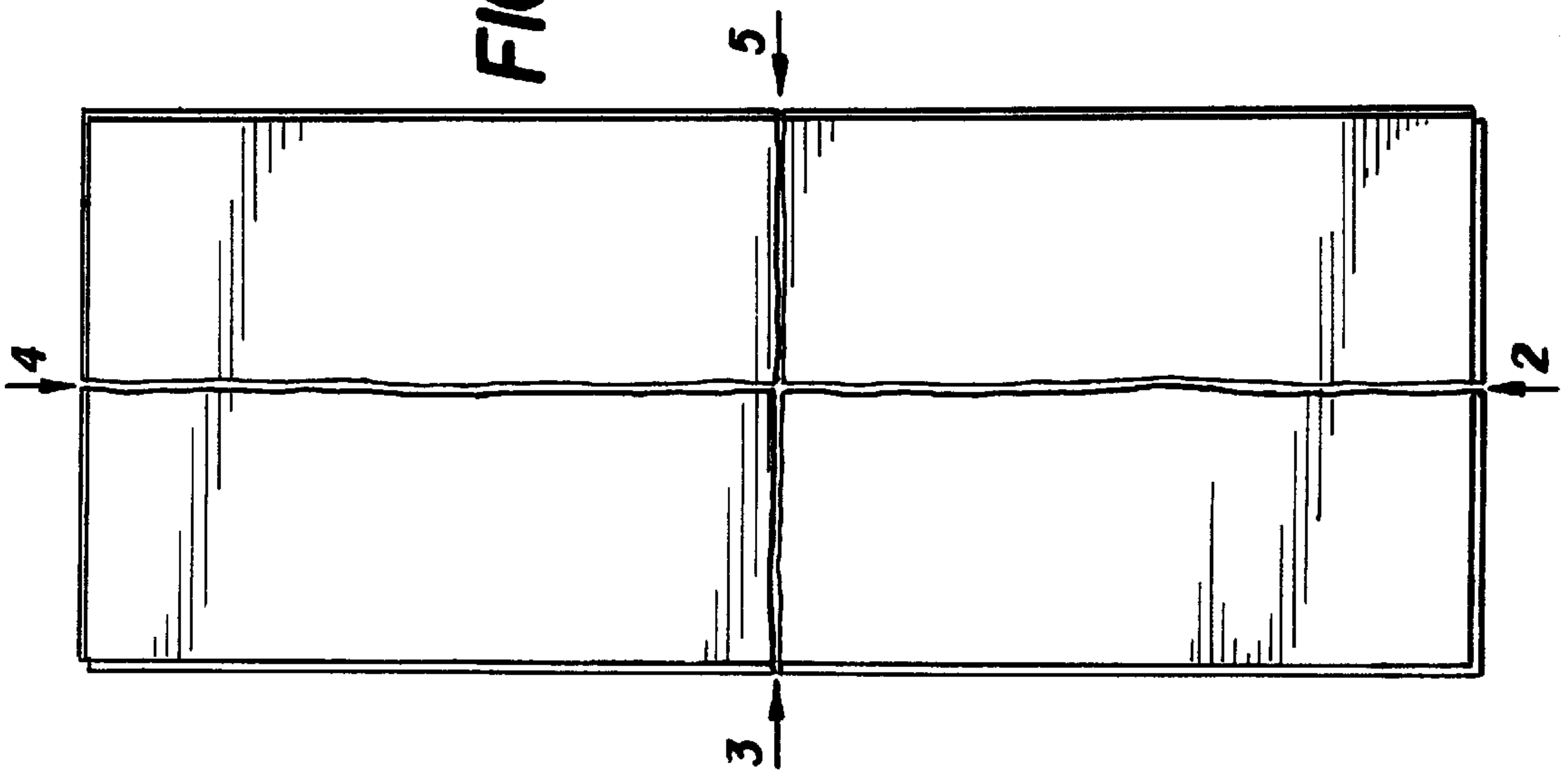

FIG. 1

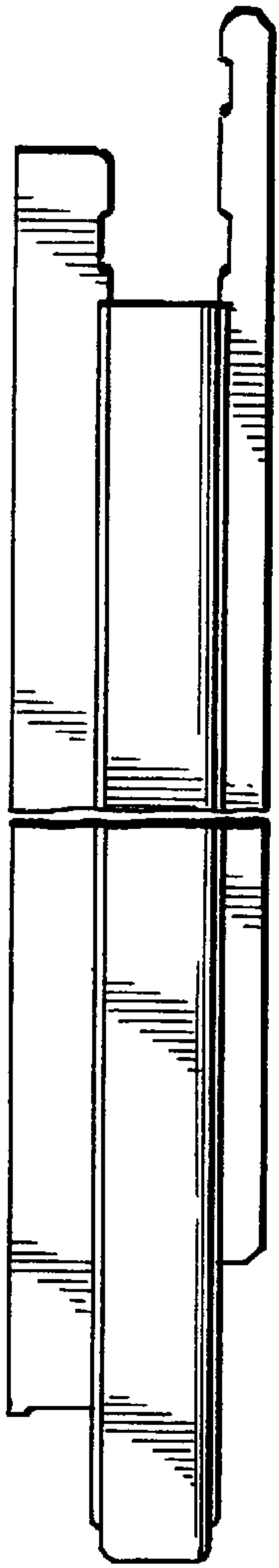

FIG. 2

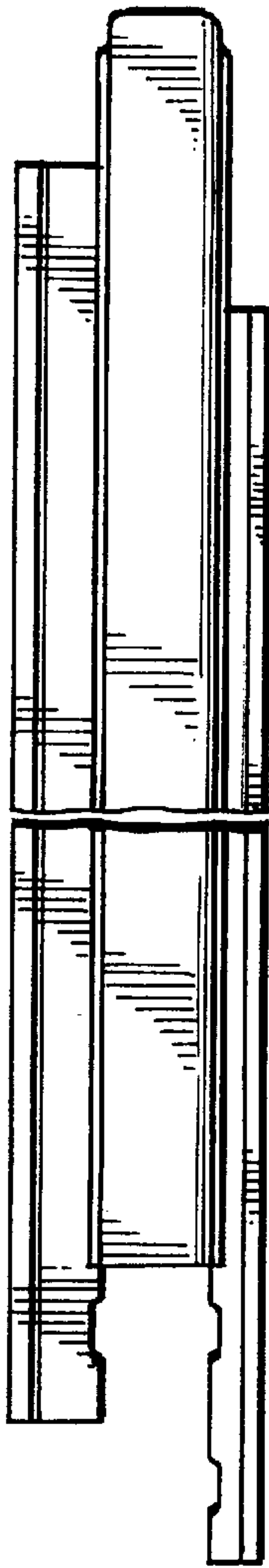

FIG. 3

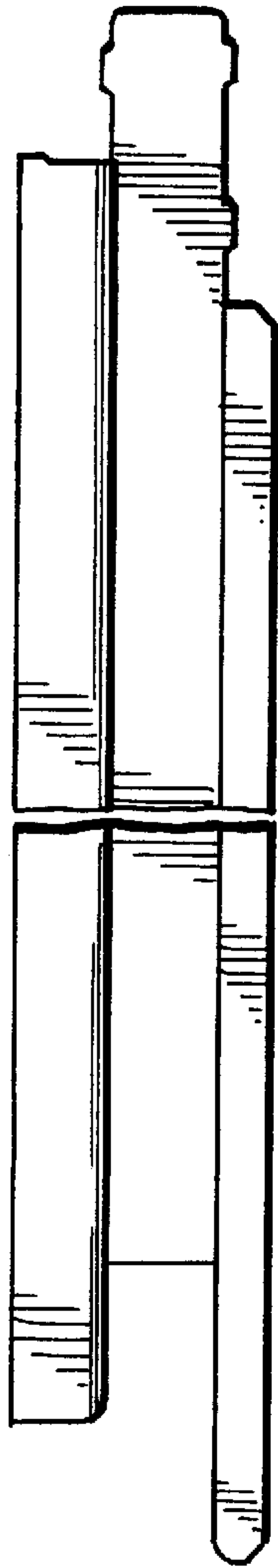

FIG. 4

FIG. 5

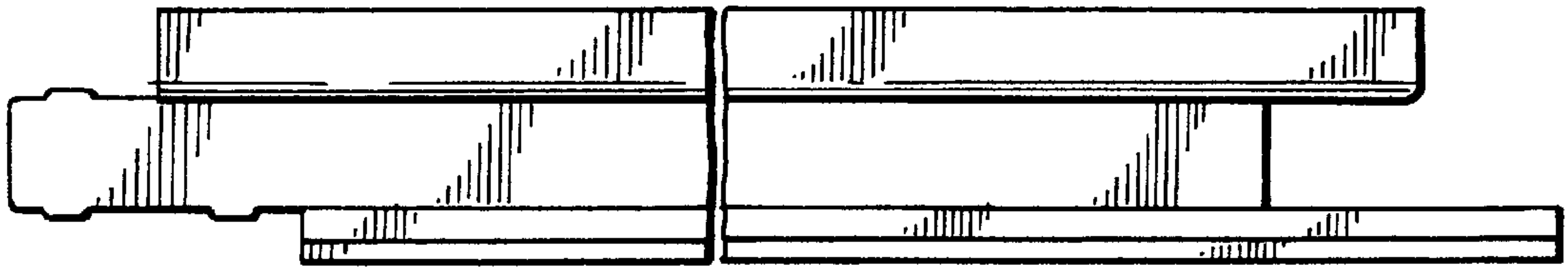
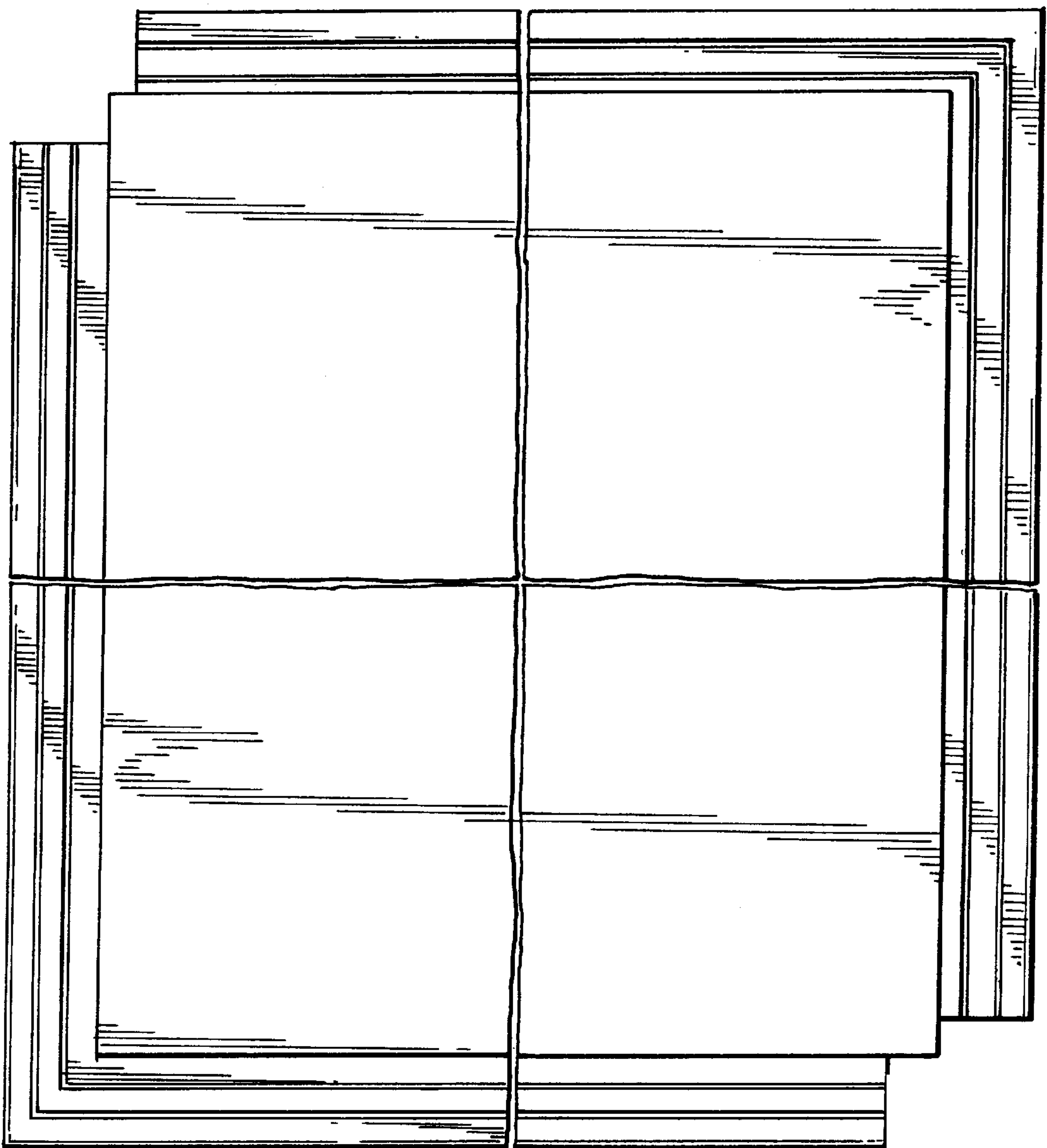

FIG. 6



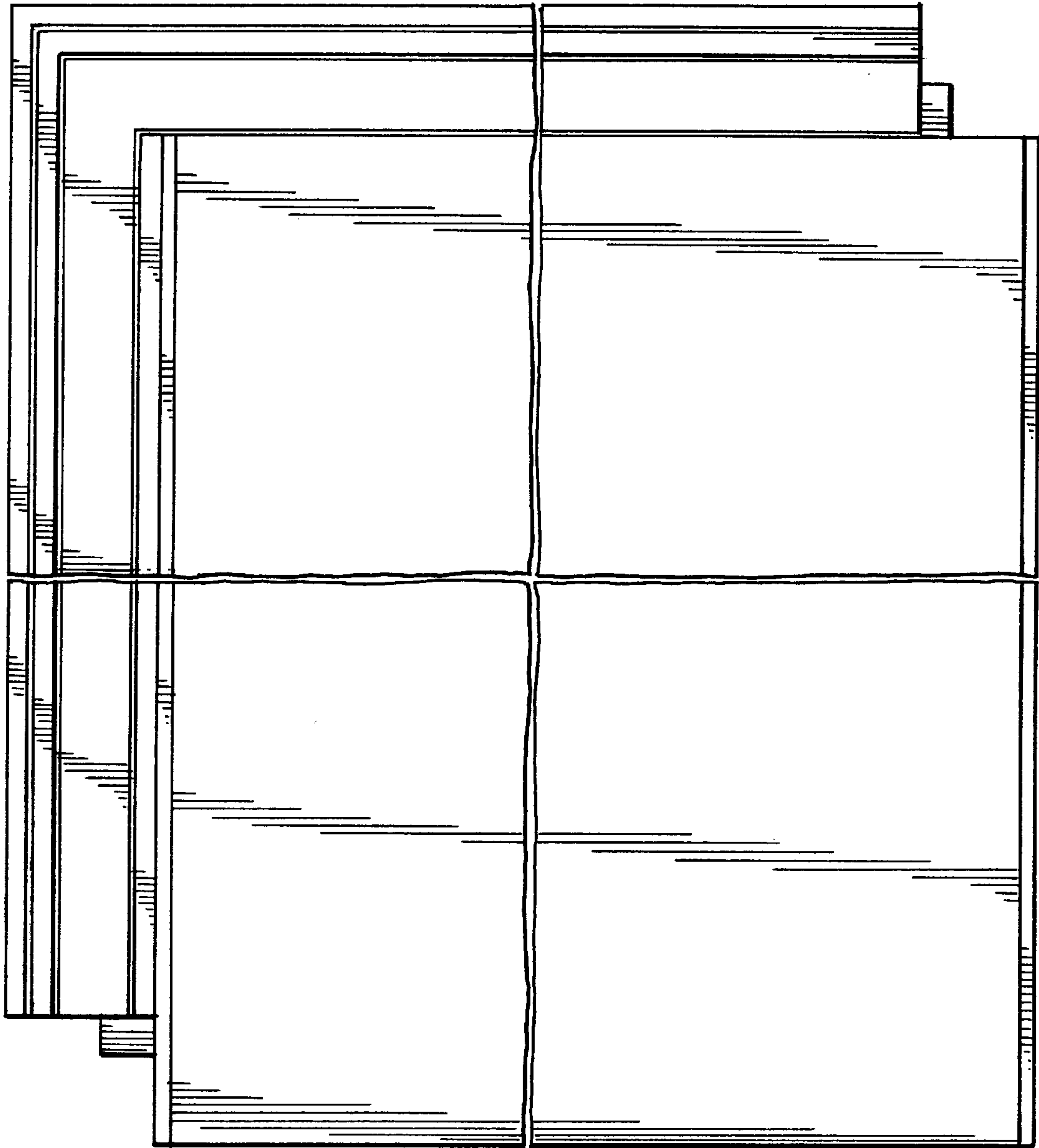

FIG. 7