



US00D442169S

(12) **United States Design Patent**
Shore et al.

(10) **Patent No.:** **US D442,169 S**

(45) **Date of Patent:** **** May 15, 2001**

(54) **AUTOMOBILE ORNAMENT**

(76) Inventors: **Darryl Shore; Chanelle Shore**, both of
5204 144th St., SE., Everett, WA (US)
98208

(**) Term: **14 Years**

(21) Appl. No.: **29/124,748**

(22) Filed: **Jun. 10, 2000**

(51) **LOC (7) Cl.** **14-03**

(52) **U.S. Cl.** **D14/232; D11/160; D11/157**

(58) **Field of Search** **D14/230, 232;**
D12/162; D11/135, 160, 157; 40/591, 592;
116/23 R; D21/627

(56) **References Cited**

U.S. PATENT DOCUMENTS

D. 325,762	*	4/1992	Hoglund	D21/627
D. 358,794	*	5/1995	Thigpen	D12/162
D. 390,497	*	2/1998	Twogood, Sr.	D11/157
D. 421,441	*	3/2000	Aanenson	D14/232
D. 425,515	*	5/2000	Suh	D14/232
5,836,261	*	11/1998	Sutton	116/28 R

* cited by examiner

Primary Examiner—Louis S. Zarfes

Assistant Examiner—Gregory Andoll

(74) *Attorney, Agent, or Firm*—Goldstein & Canino

(57) **CLAIM**

The ornamental design for an automobile ornament, as shown and described.

DESCRIPTION

FIG. 1 is a perspective view of an automobile ornament in full lines with an automobile shown in broken lines representing environmental association matter being for illustrative purposes only and forming no part of the claimed invention;

FIG. 2 is a front elevational view of the automobile ornament;

FIG. 3 is a rear elevational view thereof;

FIG. 4 is a top plan view thereof;

FIG. 5 is a bottom plan view thereof; and,

FIG. 6 is a right side elevational view of the automobile ornament, the left side elevational view being a mirror image of the right side view.

1 Claim, 2 Drawing Sheets

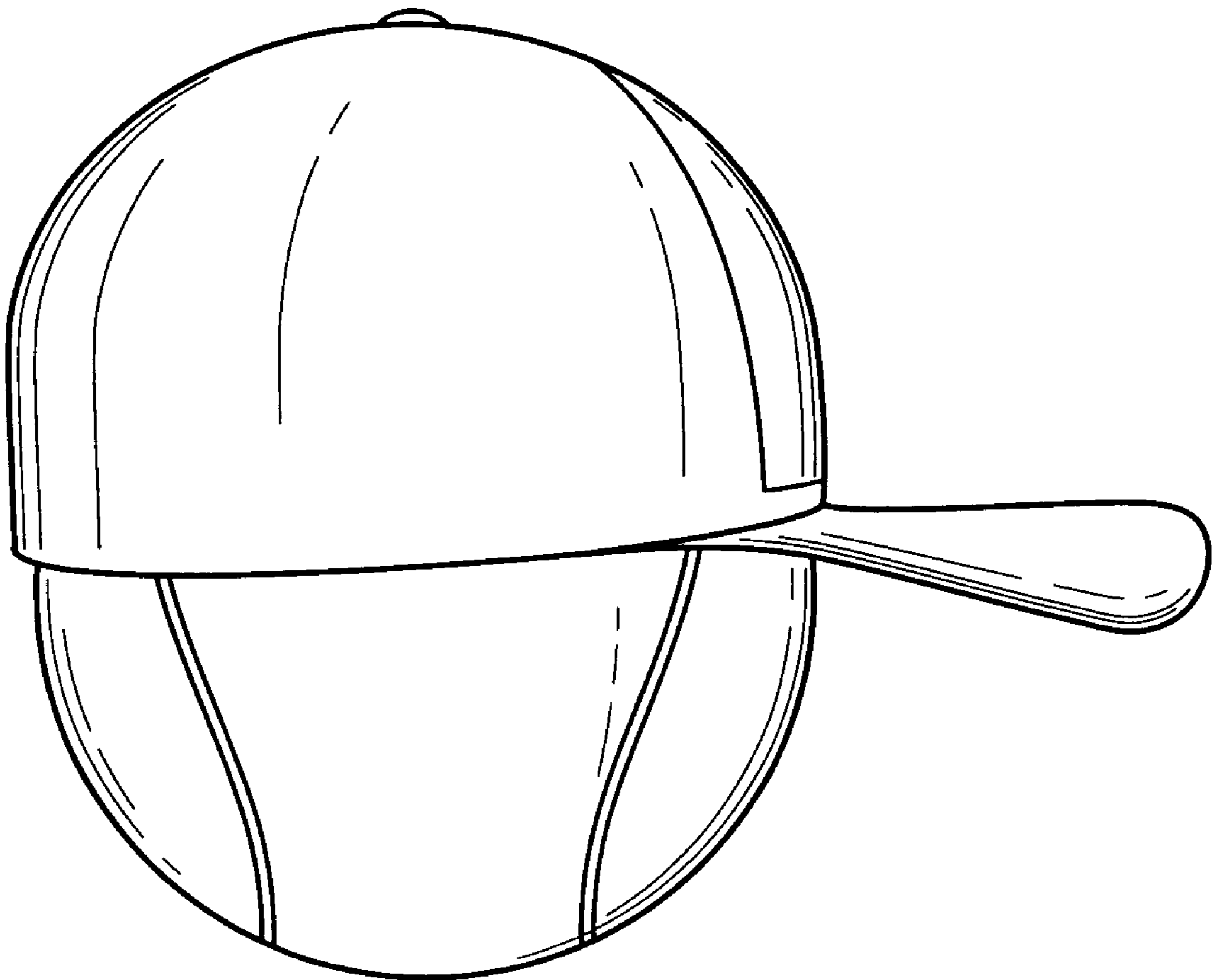

Fig. 1

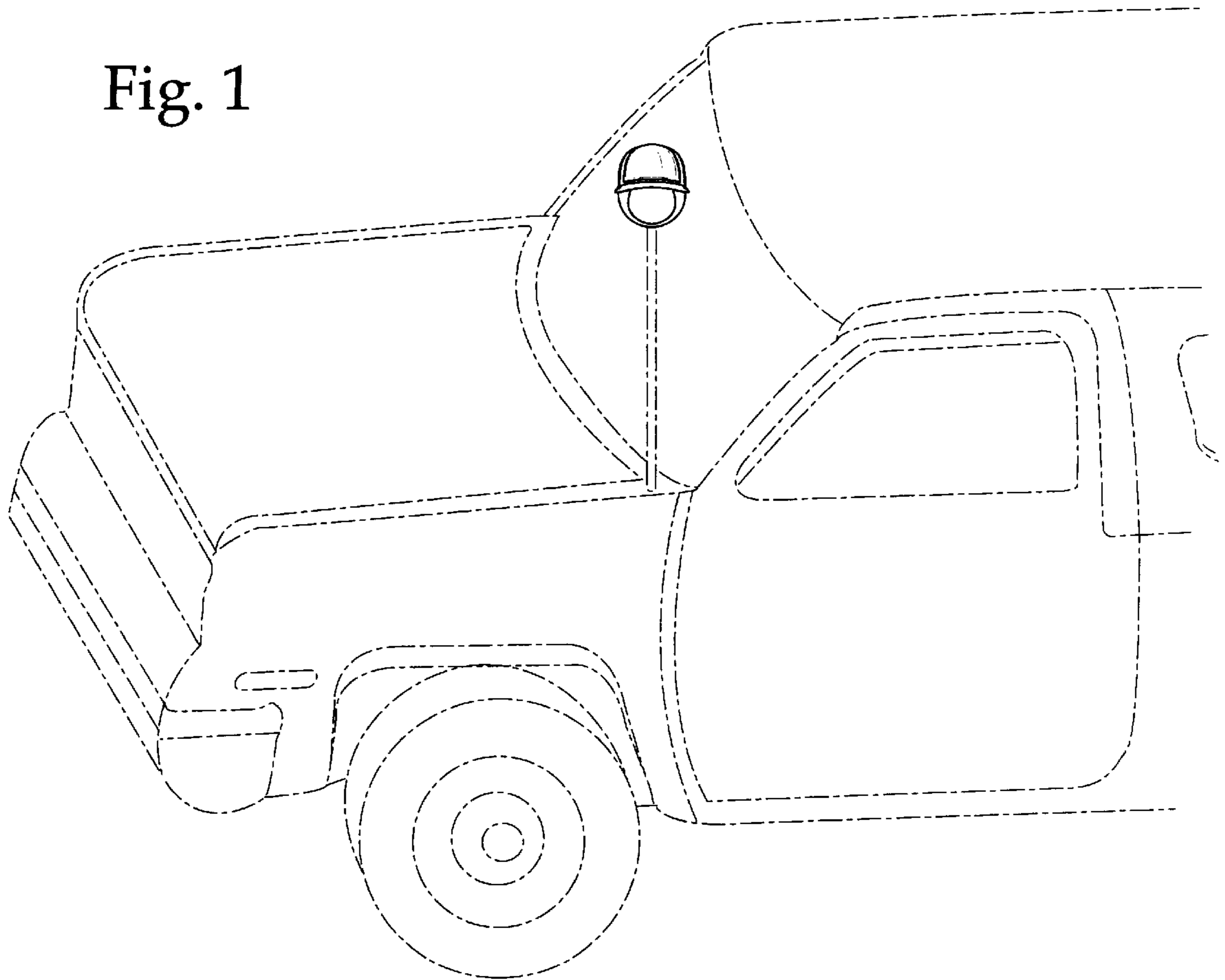

Fig. 2

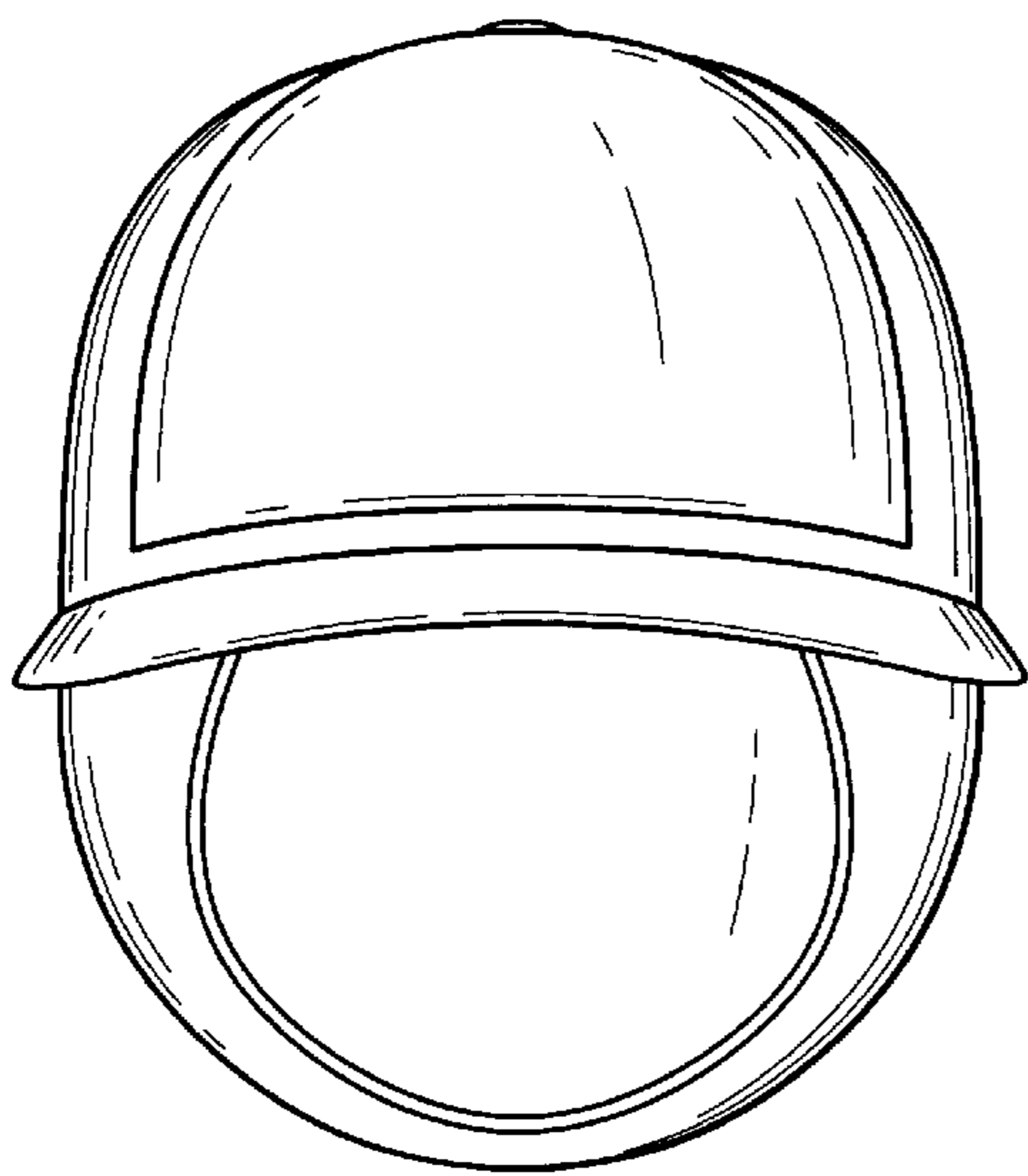
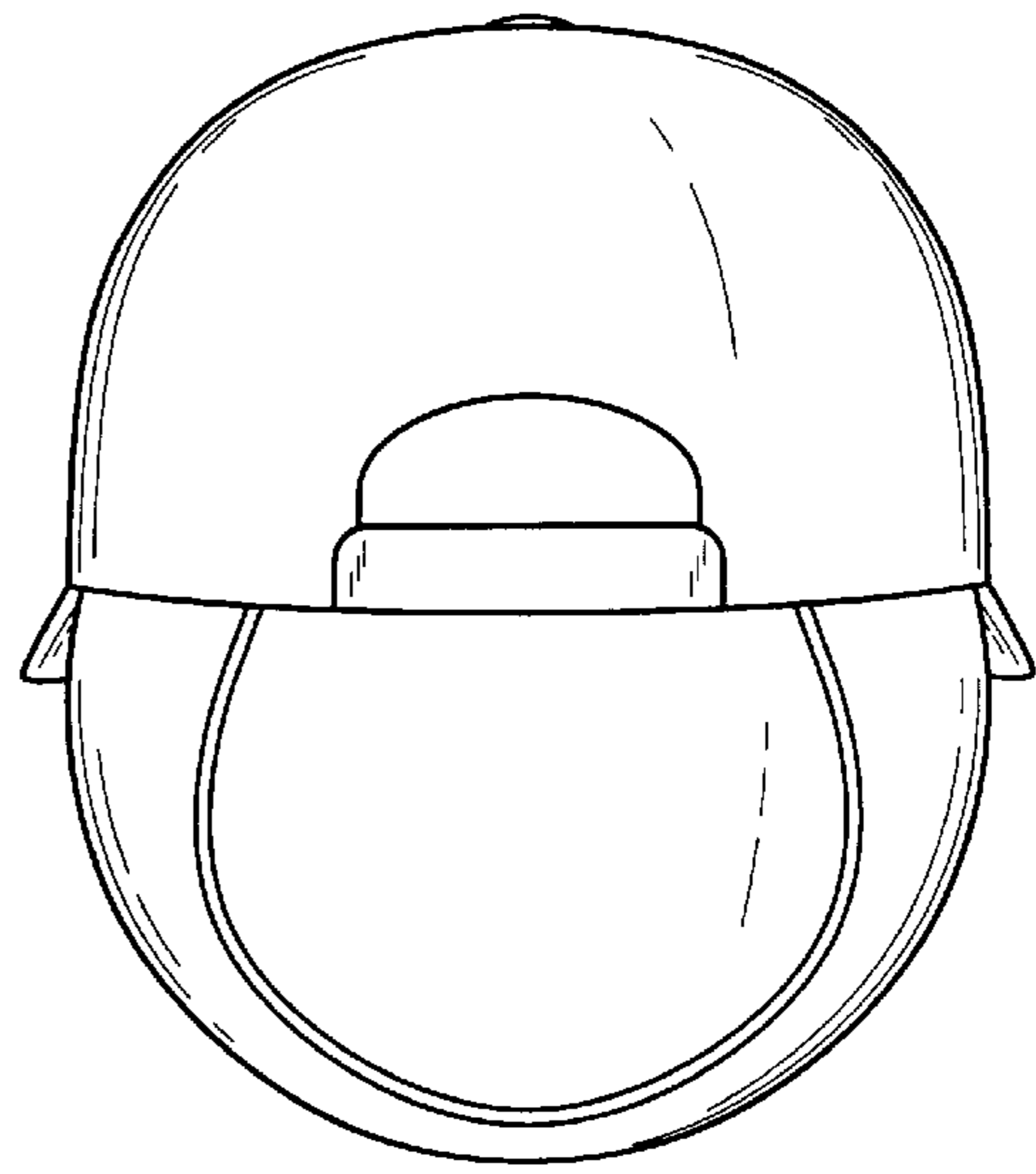

Fig. 3



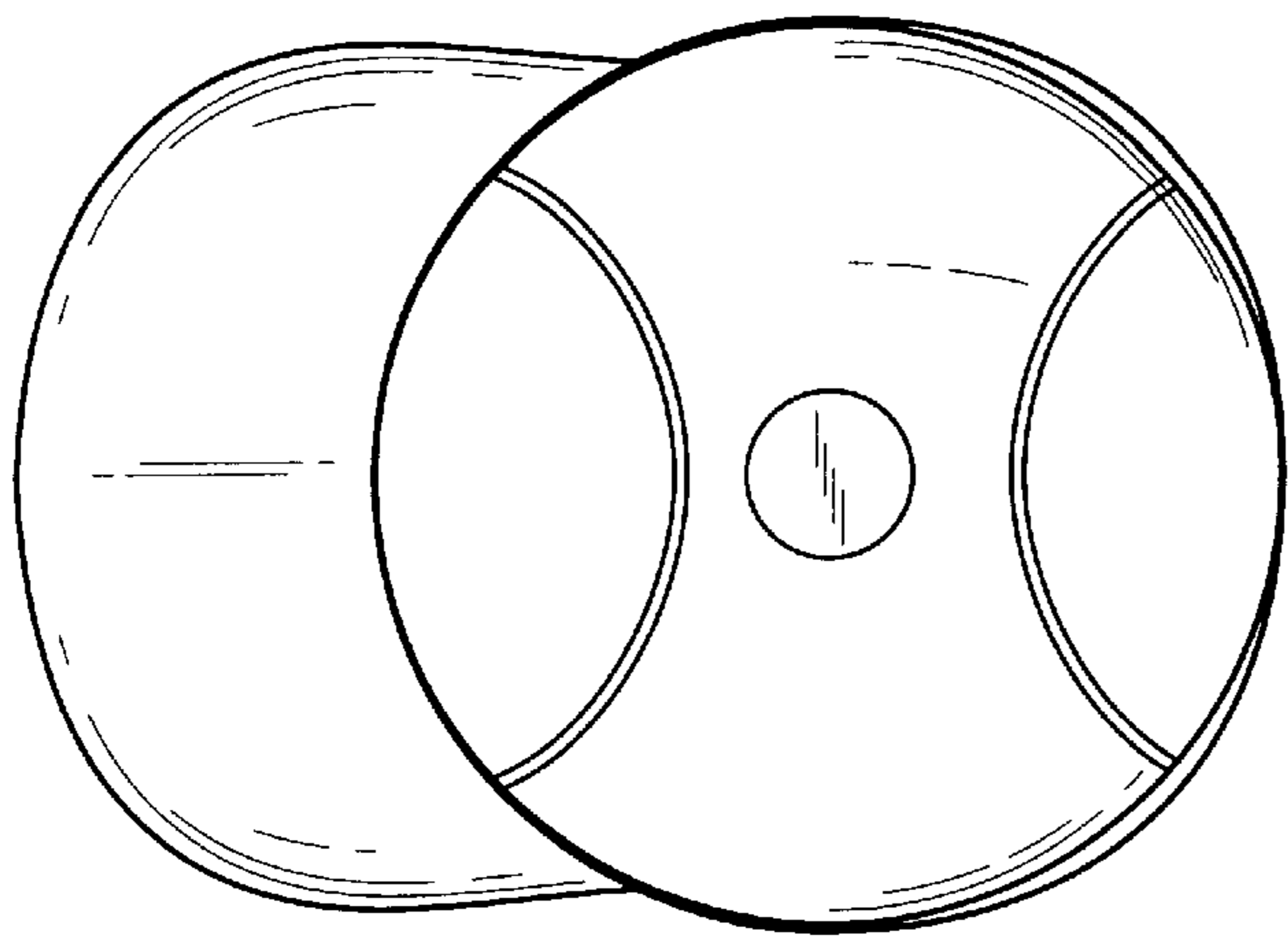

Fig. 5

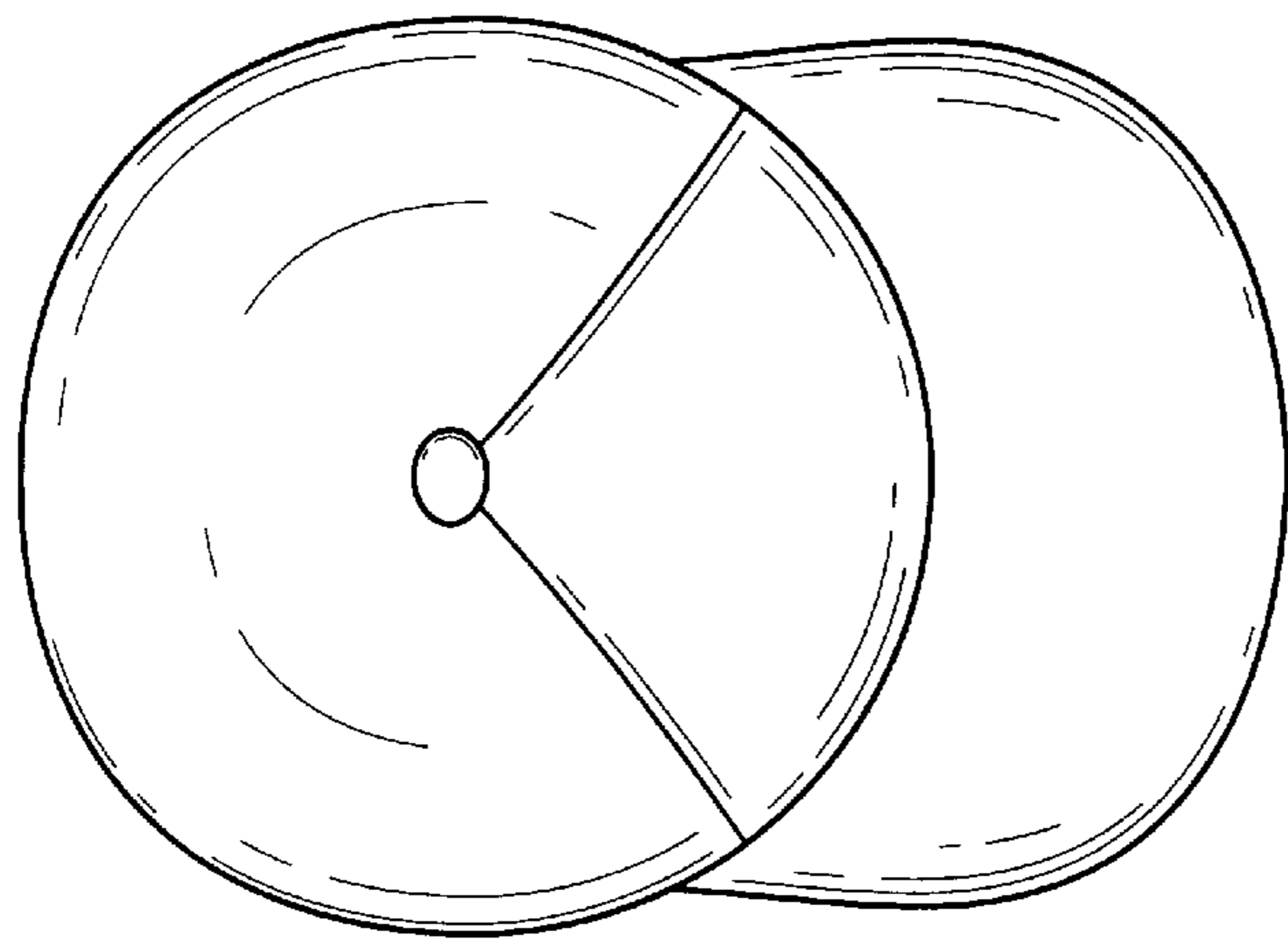

Fig. 4

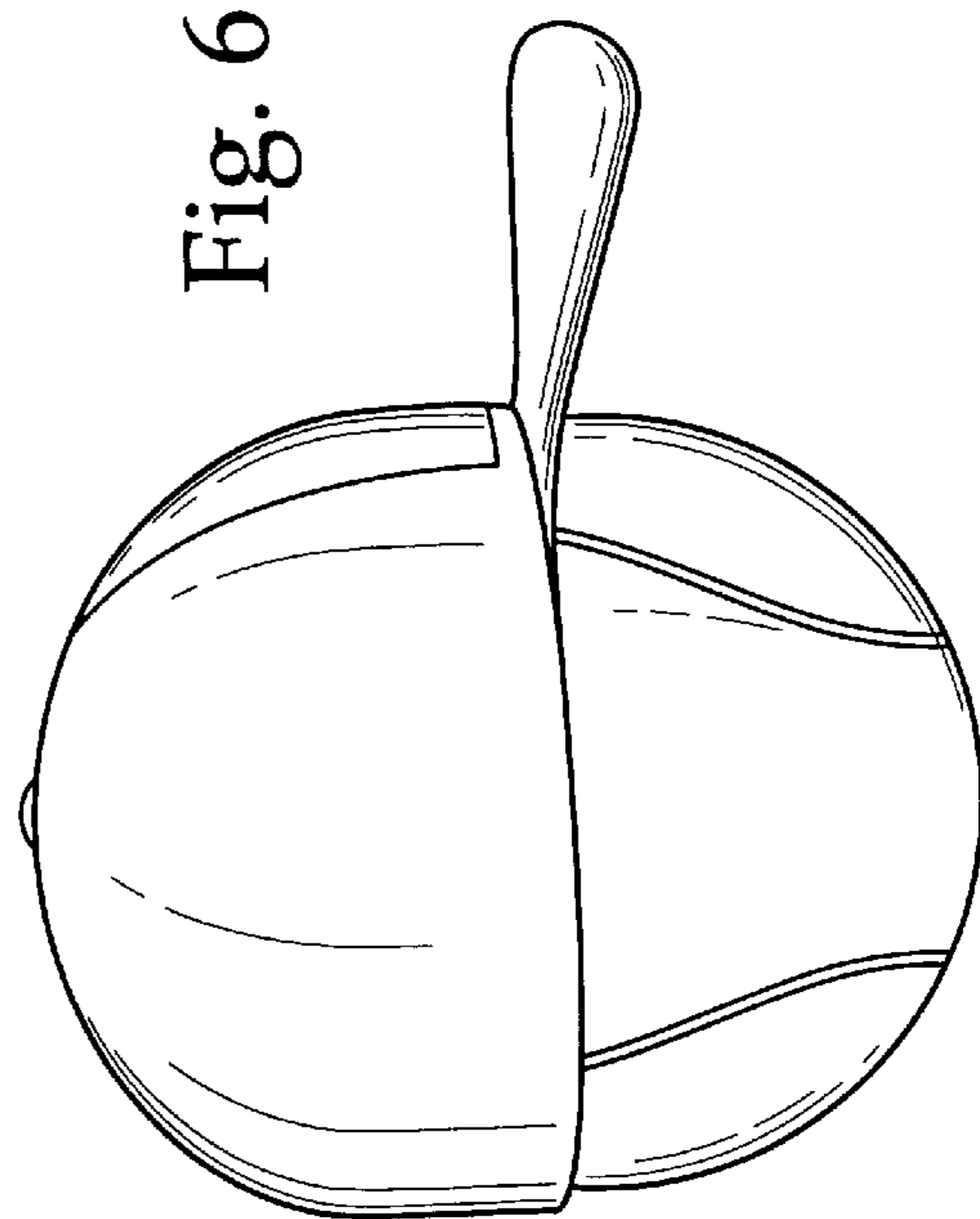

Fig. 6