



US00D442073S

(12) **United States Design Patent**
Lyndon

(10) **Patent No.:** **US D442,073 S**

(45) **Date of Patent:** **** May 15, 2001**

(54) **HOOK**

4,912,829 * 4/1990 Hickey 29/525.1

(75) Inventor: **Maynard Hale Lyndon**, Newton
Centre, MA (US)

* cited by examiner

(73) Assignee: **Umbra, Inc.**, Buffalo, NY (US)

Primary Examiner—Pamela Burgess

(**) Term: **14 Years**

(74) *Attorney, Agent, or Firm*—SAIDMAN DesignLaw
Group

(21) Appl. No.: **29/134,725**

(57) **CLAIM**

The ornamental design for a hook, as shown and described.

(22) Filed: **Dec. 28, 2000**

DESCRIPTION

(51) **LOC (7) Cl.** **08-99**

FIG. 1 is a perspective view of a hook showing my new
design;

(52) **U.S. Cl.** **D8/367; D6/323; D8/358**

FIG. 2 is a front view thereof;

(58) **Field of Search** D8/367, 371, 373,
D8/358; D6/323, 547, 550; 248/215, 301,
339; 160/349.1, 349.2; 24/265 H, 265 R,
599.1, 599.8, 113 R; 294/82.18; 29/525.1,
453; D3/24; 223/106

FIG. 3 is a top view thereof, the bottom view being identical;
FIG. 4 is a left side view thereof, the right side view being
identical;

FIG. 5 is a perspective view of a second embodiment of my
design; and,

(56) **References Cited**

FIG. 6 is a perspective view of a third embodiment of my
design.

U.S. PATENT DOCUMENTS

The dashed lines in FIG. 6 are shown for environmental
purposes only and form no part of the claimed design. The
dotted lines shown in FIGS. 1, 2, 5, and 6 represent
peripheries of the claimed design and form no part thereof.

- D. 281,838 * 12/1985 Thompson D6/323
- D. 330,636 * 11/1992 Sharpe D6/323
- D. 388,619 * 1/1998 Klein et al. D6/323
- D. 423,335 * 4/2000 Snell D6/367

1 Claim, 5 Drawing Sheets

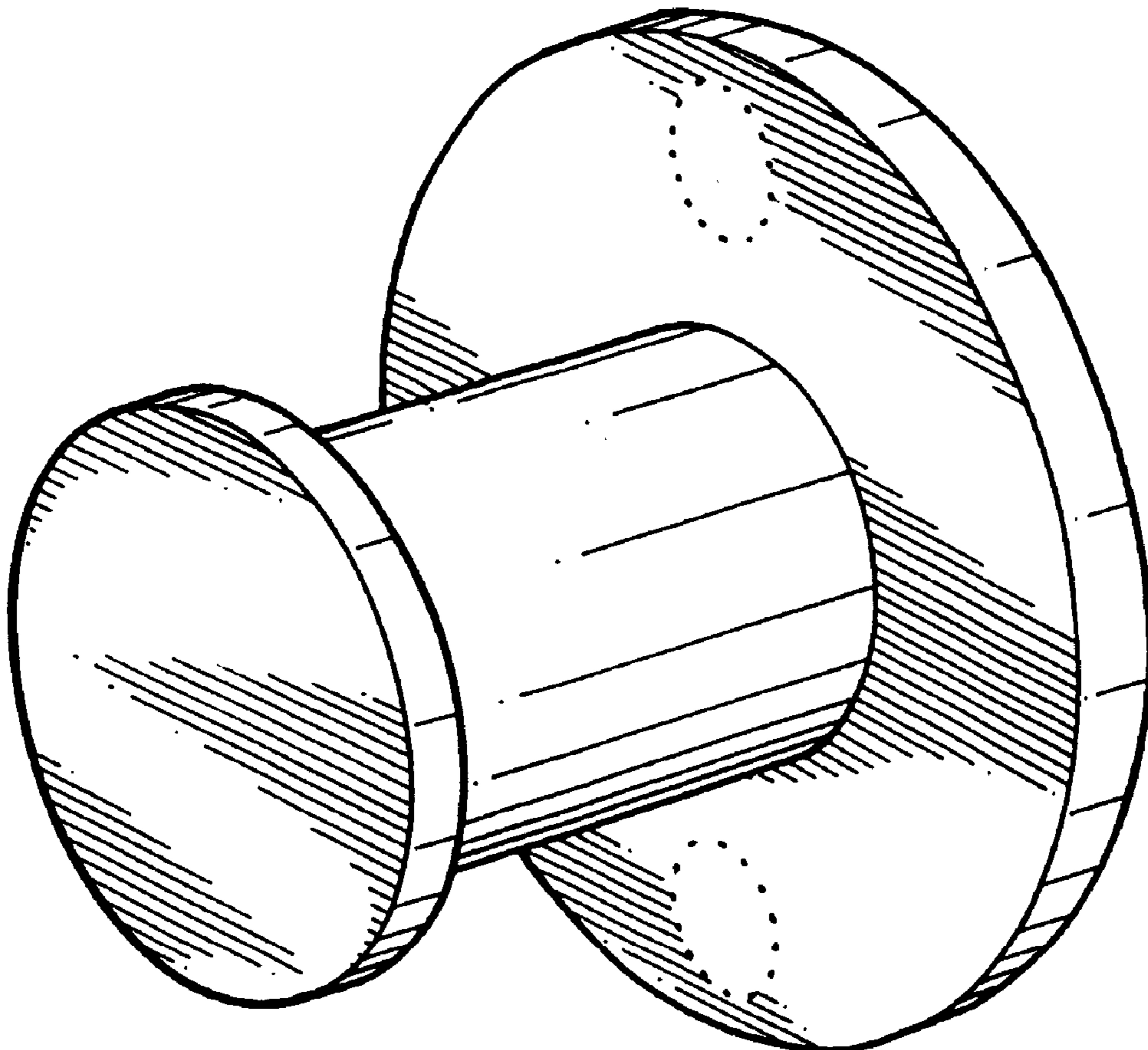

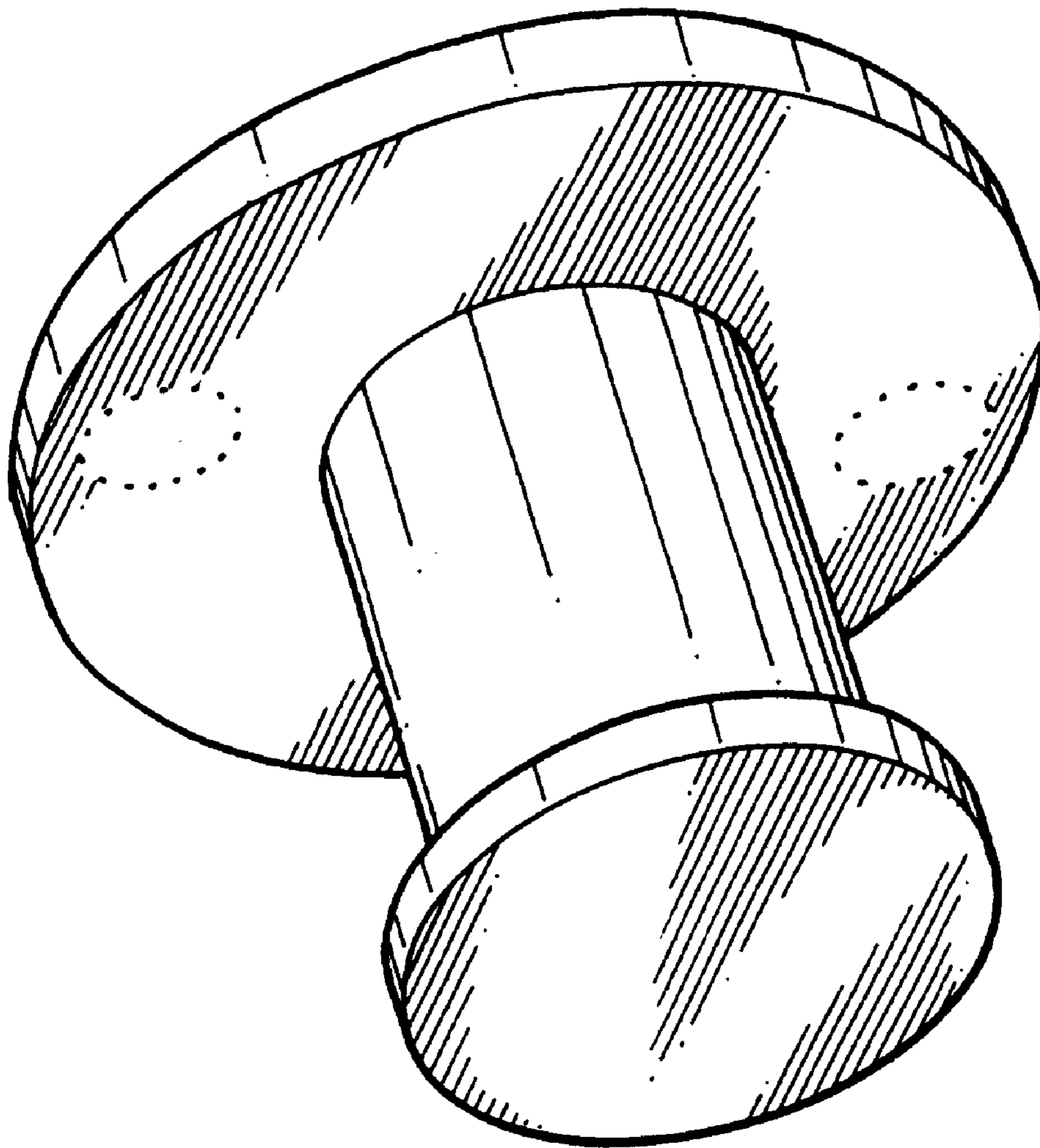

FIG.1

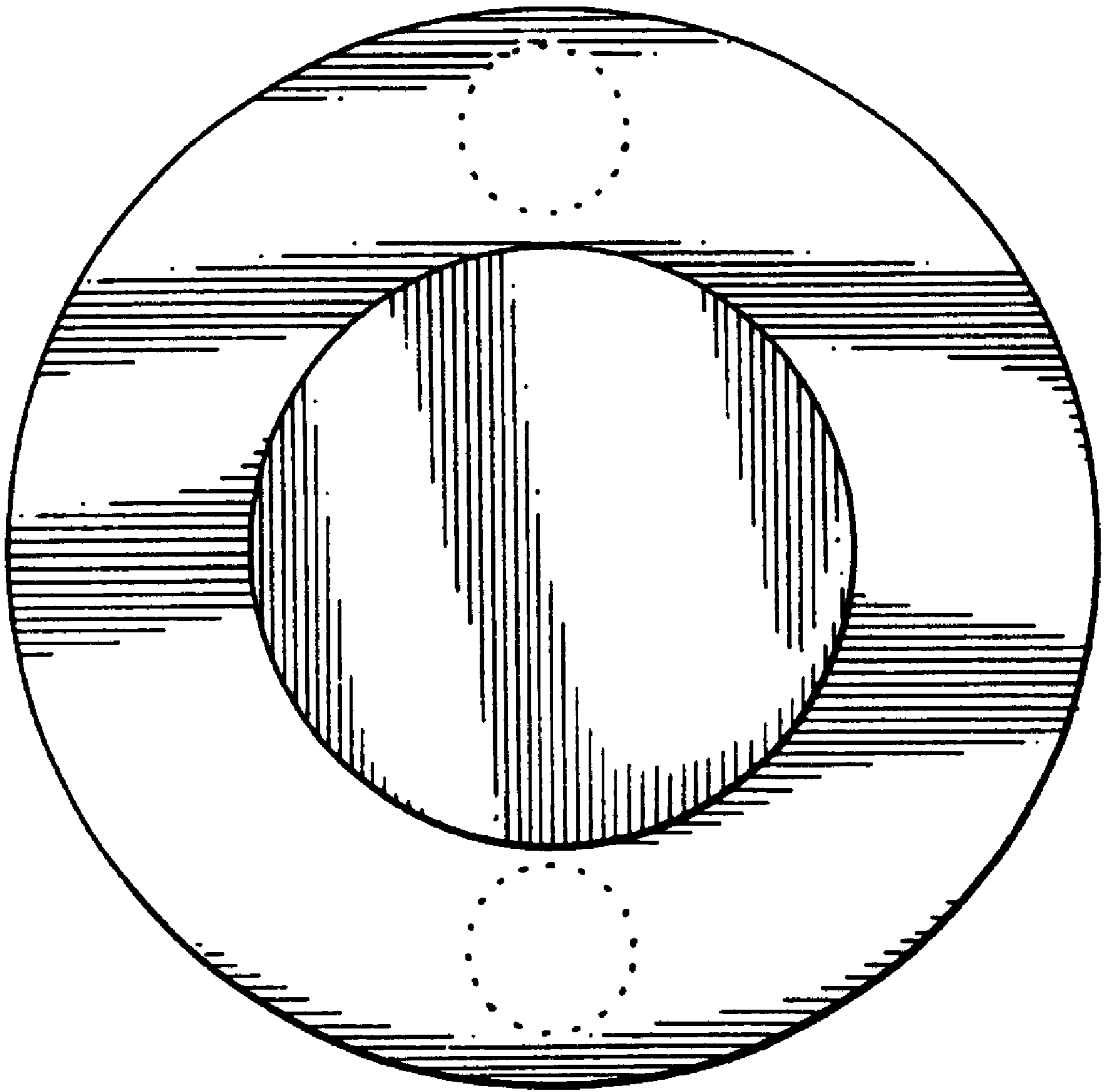

FIG.2

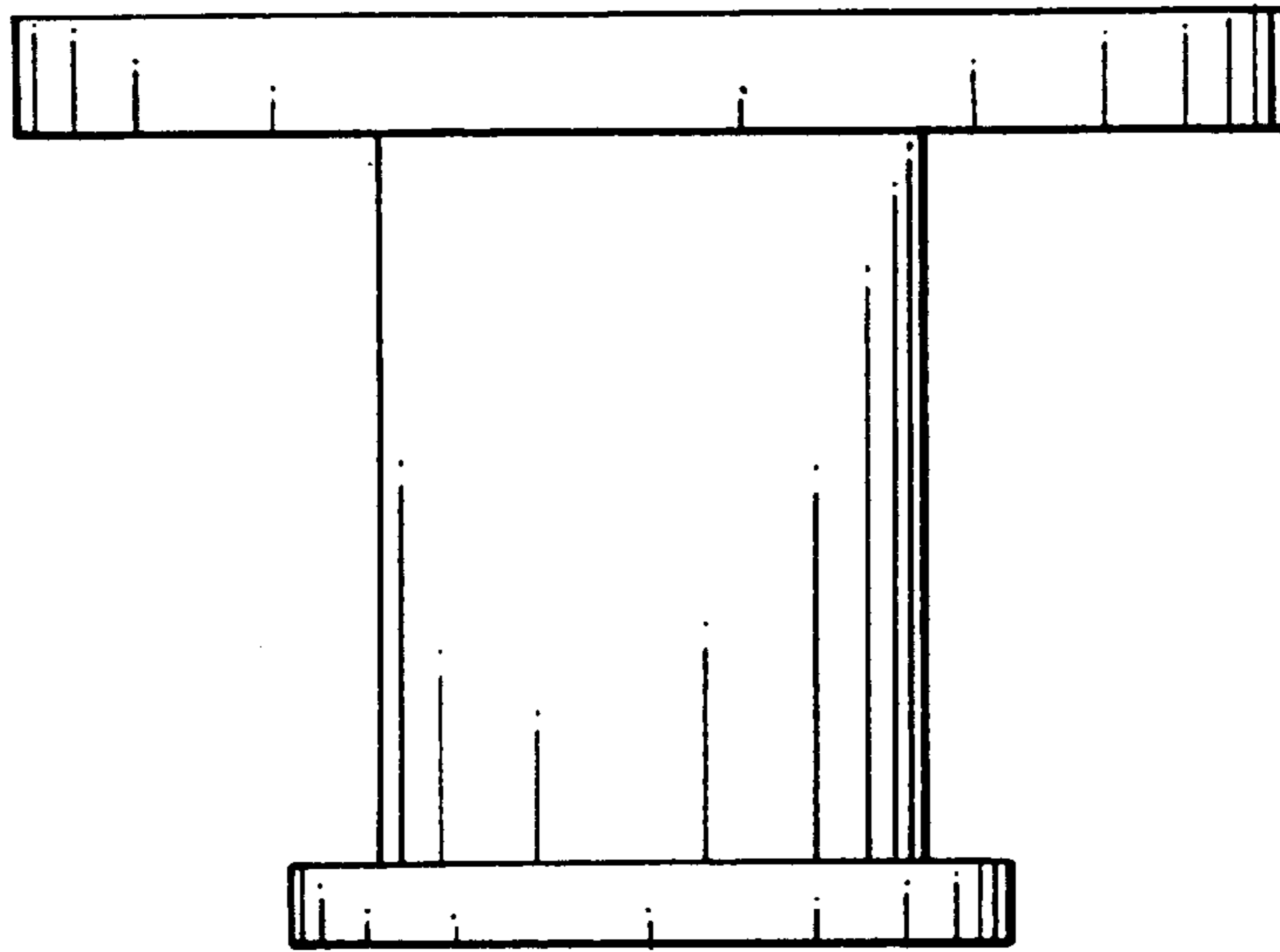

FIG.3

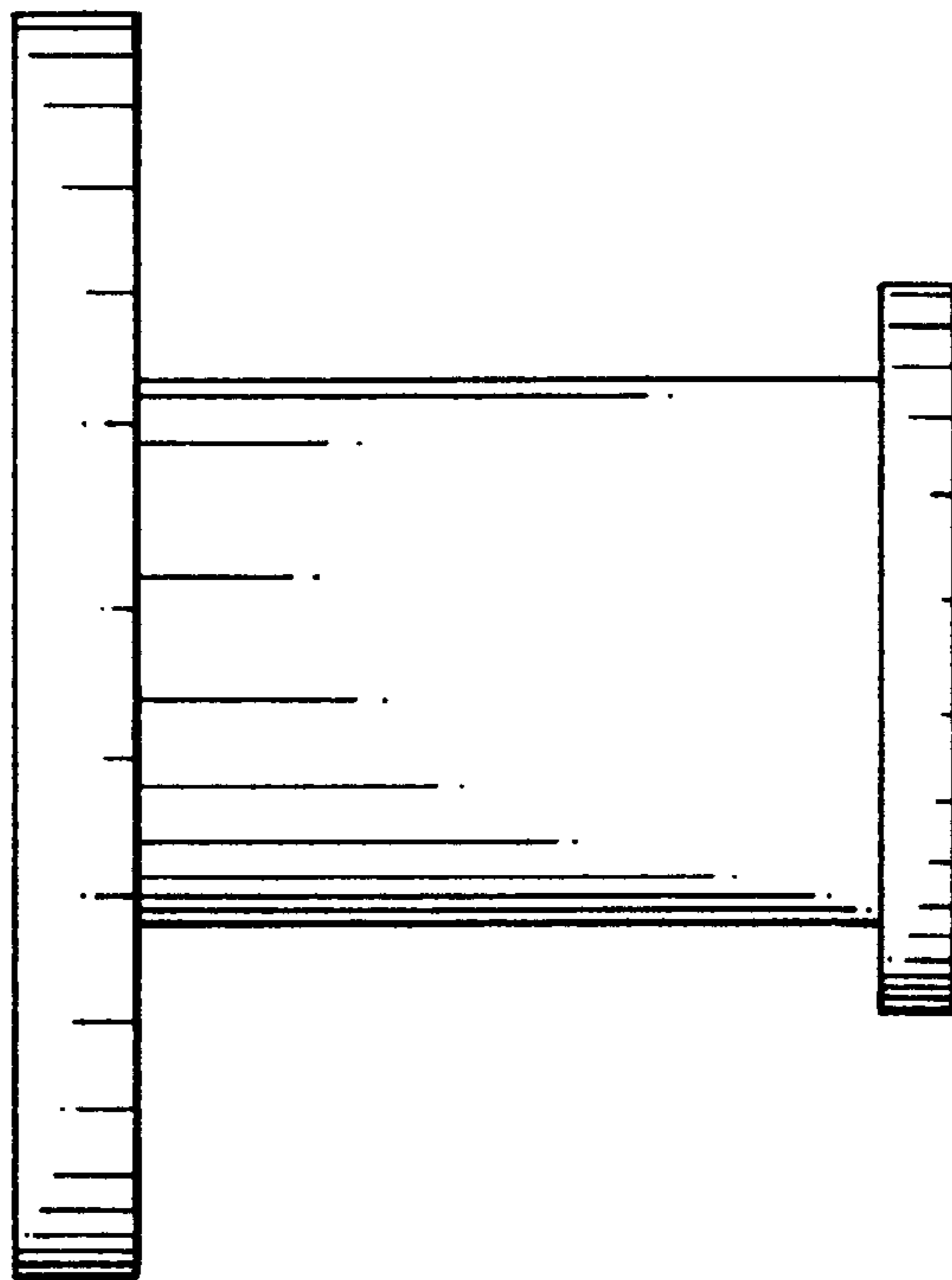

FIG.4

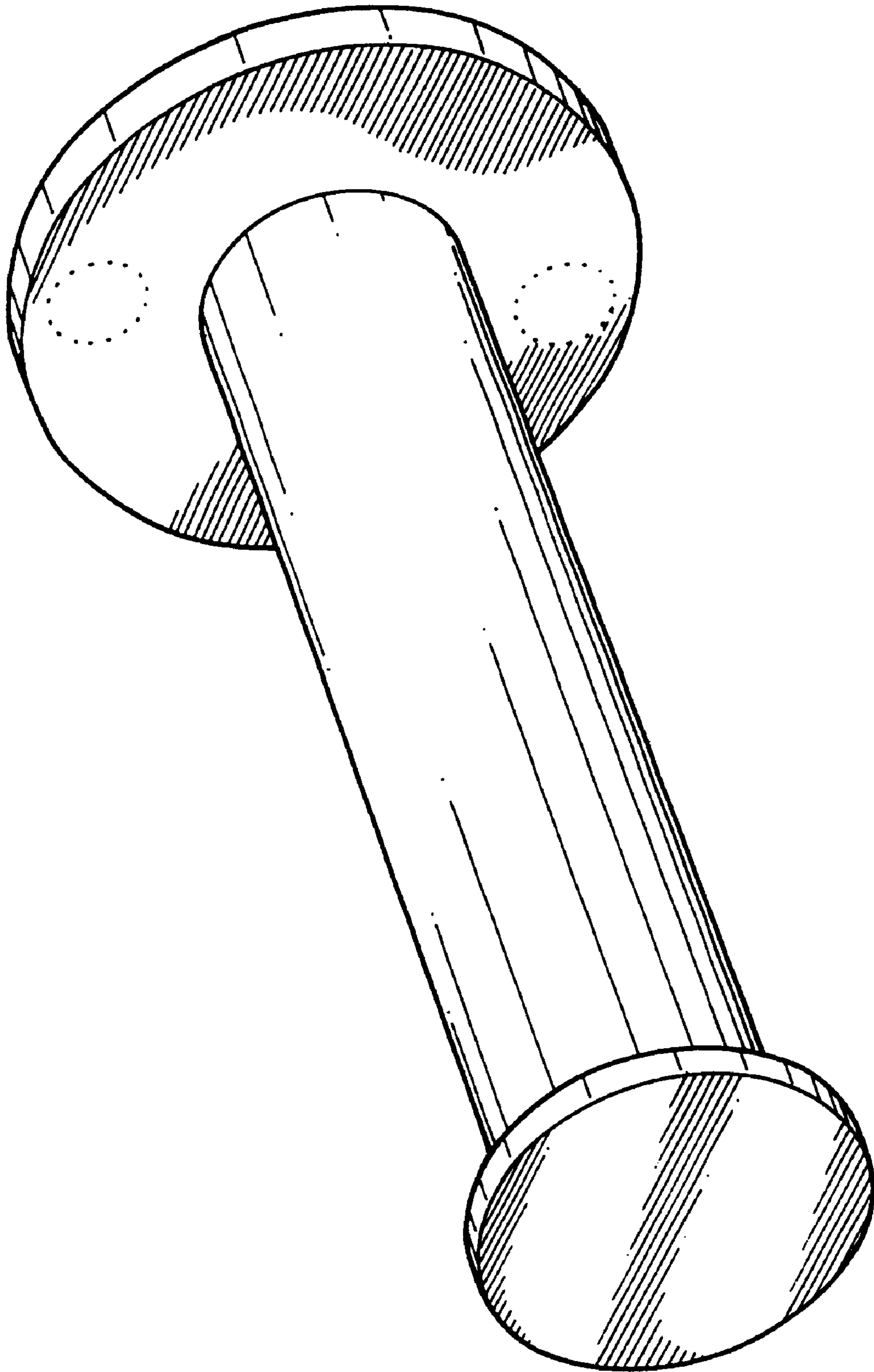

FIG. 5

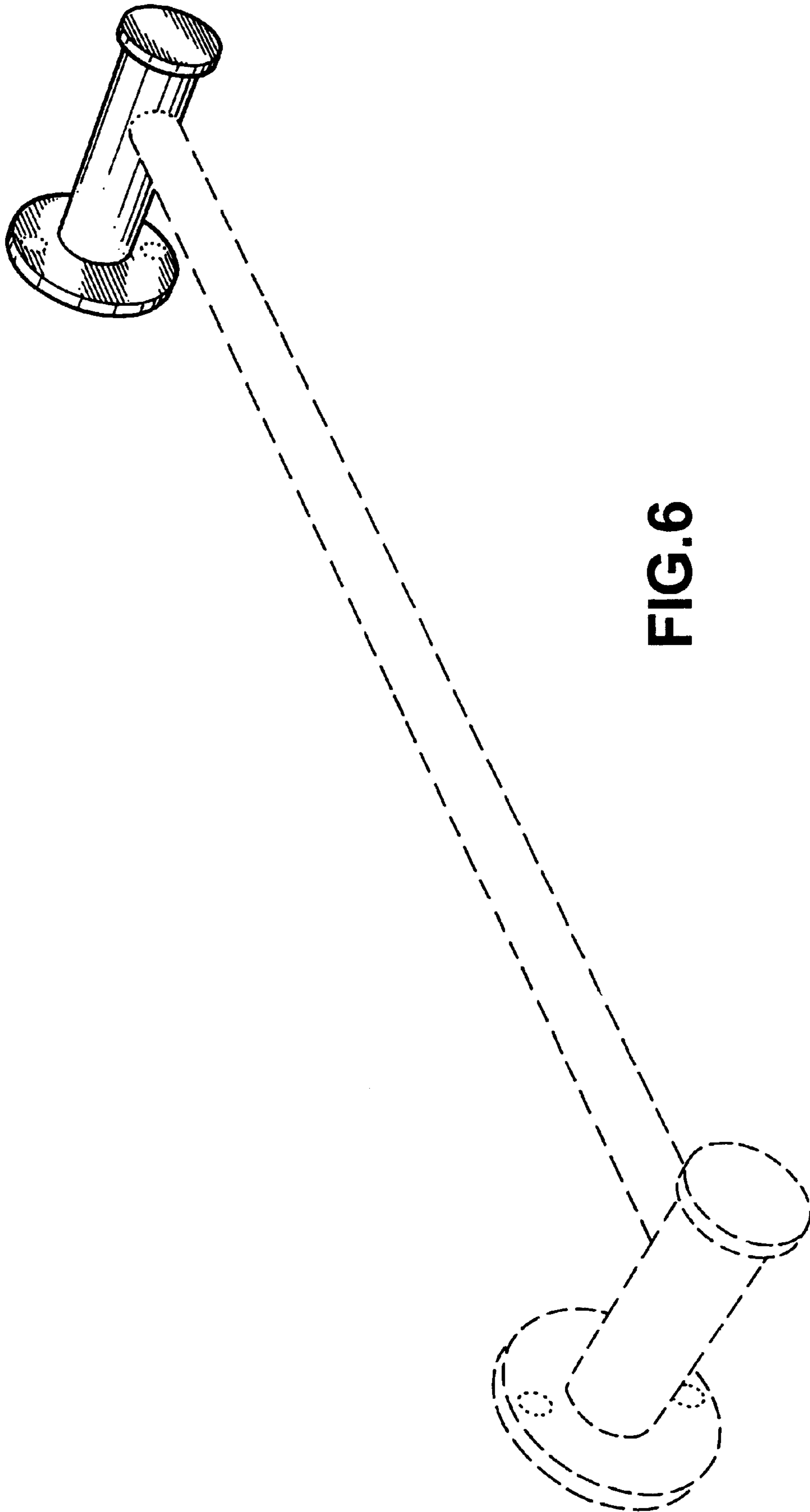

FIG. 6