



US00D442060S

(12) **United States Design Patent**
Neset et al.

(10) **Patent No.:** **US D442,060 S**

(45) **Date of Patent:** **** May 15, 2001**

- (54) **AUTOMOTIVE VEHICLE KEY**
- (75) Inventors: **Lowell Charles Neset**, Dearborn Heights; **Daryl Harris**, Farmington Hills, both of MI (US)
- (73) Assignee: **Ford Global Technologies, Inc.**, Dearborn, MI (US)
- (**) Term: **14 Years**
- (21) Appl. No.: **29/122,600**
- (22) Filed: **Apr. 28, 2000**
- (51) **LOC (7) Cl.** **08-07**
- (52) **U.S. Cl.** **D8/347; D8/346**
- (58) **Field of Search** **D8/346, 347, 348; 70/393, 396, 402, 405, 408, 456 R, 458, 459; D3/207, 212**

| | | | |
|-----------|----------|------------------|----------|
| 2,989,861 | 6/1961 | Schefman . | |
| 3,277,680 | 10/1966 | Merila . | |
| 3,363,440 | 1/1968 | Rivers . | |
| 3,394,565 | 7/1968 | Turman . | |
| 3,421,349 | 1/1969 | St. Clair, Jr. . | |
| 3,427,834 | 2/1969 | Tutino . | |
| 3,527,072 | 9/1970 | Demetreon . | |
| 3,672,192 | 6/1972 | Dontas . | |
| 4,726,205 | 2/1988 | Allerdist . | |
| 4,888,970 | 12/1989 | Kinzler . | |
| 4,941,569 | 7/1990 | Lindmayer . | |
| 5,117,666 | * 6/1992 | Keefer | 70/456 R |
| 5,433,096 | 7/1995 | Janssen . | |
| 5,732,579 | 3/1998 | D'Hont . | |
| 5,768,925 | 6/1998 | Ozawa . | |
| 5,819,568 | 10/1998 | Christie . | |
| 5,832,761 | 11/1998 | Chen . | |
| 5,878,611 | 3/1999 | Lerchner . | |
| 6,016,676 | * 1/2000 | McConnell | 70/408 |

* cited by examiner

Primary Examiner—Susan J. Lucas
Assistant Examiner—Jennifer Rivard
(74) *Attorney, Agent, or Firm*—David B. Kelley

(56) **References Cited**
U.S. PATENT DOCUMENTS

| | | |
|------------|---------|--------------|
| D. 3,942 | 3/1870 | Elwell . |
| D. 178,844 | 9/1956 | Mencaccini . |
| D. 179,844 | 3/1957 | Gehrie . |
| D. 250,990 | 2/1979 | Hanneman . |
| D. 307,704 | 5/1990 | Vonlanthen . |
| D. 334,528 | 4/1993 | Franklin . |
| D. 358,543 | 5/1995 | Amber . |
| D. 400,779 | 11/1998 | Chen . |
| D. 404,284 | 1/1999 | Sacco . |
| D. 407,006 | 3/1999 | Sacco . |
| D. 407,007 | 3/1999 | Sacco . |
| 2,514,940 | 7/1950 | Doss . |
| 2,547,340 | 4/1951 | Mullan . |
| 2,547,524 | 4/1951 | Gross . |
| 2,625,814 | 1/1953 | Mullan . |
| 2,659,231 | 11/1953 | Glubiak . |
| 2,699,667 | 1/1955 | Mark . |
| 2,882,710 | 4/1959 | Furn . |
| 2,931,208 | 4/1960 | Prim . |

(57) **CLAIM**

The ornamental design for an automotive vehicle key, as shown and described.

DESCRIPTION

FIG. 1 is a perspective view of an automotive vehicle key according to our novel design;
FIG. 2 is a front view thereof;
FIG. 3 is a front view thereof with a key shank extended;
FIG. 4 is a bottom view thereof;
FIG. 5 is a top view thereof;
FIG. 6 is a left side view thereof;
FIG. 7 is a back view thereof; and,
FIG. 8 is a right side view thereof.

1 Claim, 2 Drawing Sheets

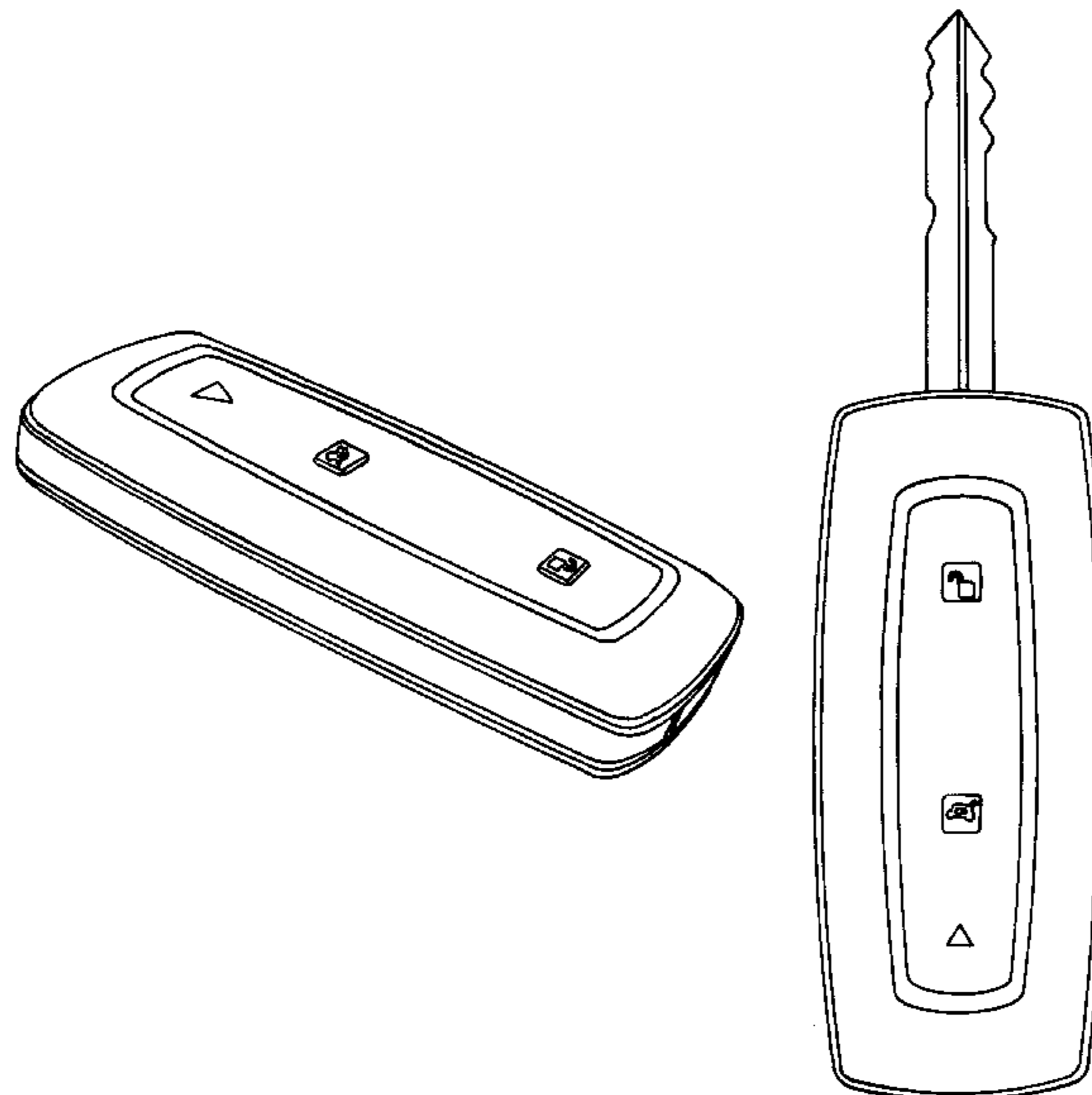

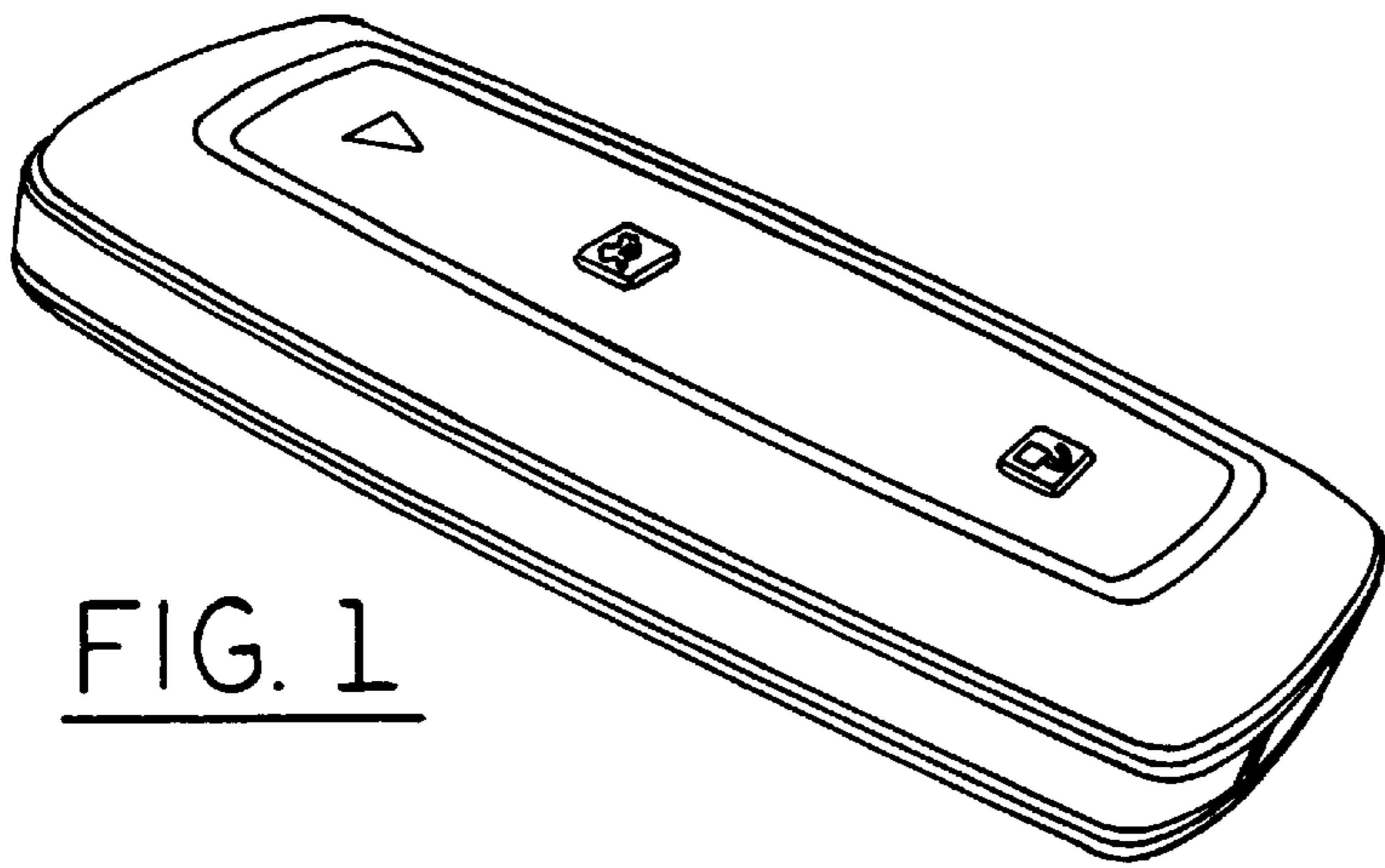

FIG. 1

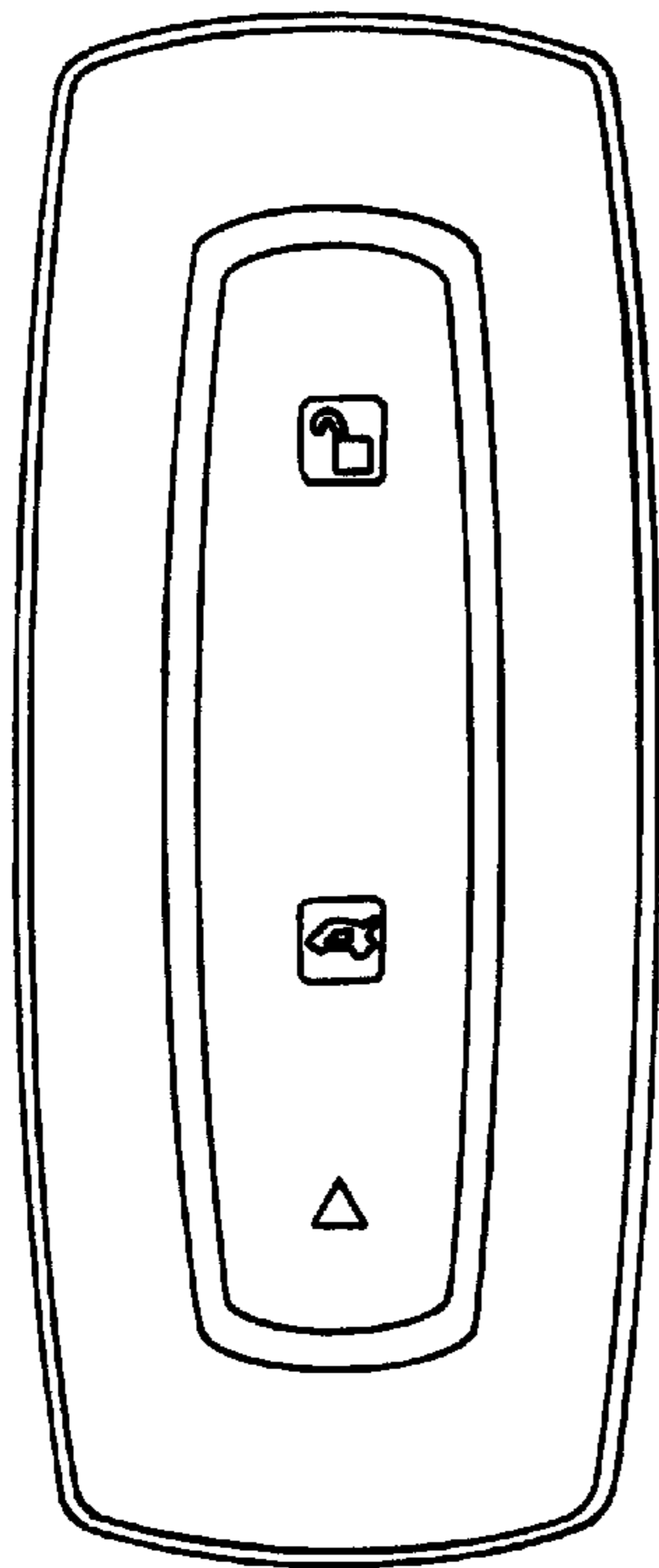

FIG. 2

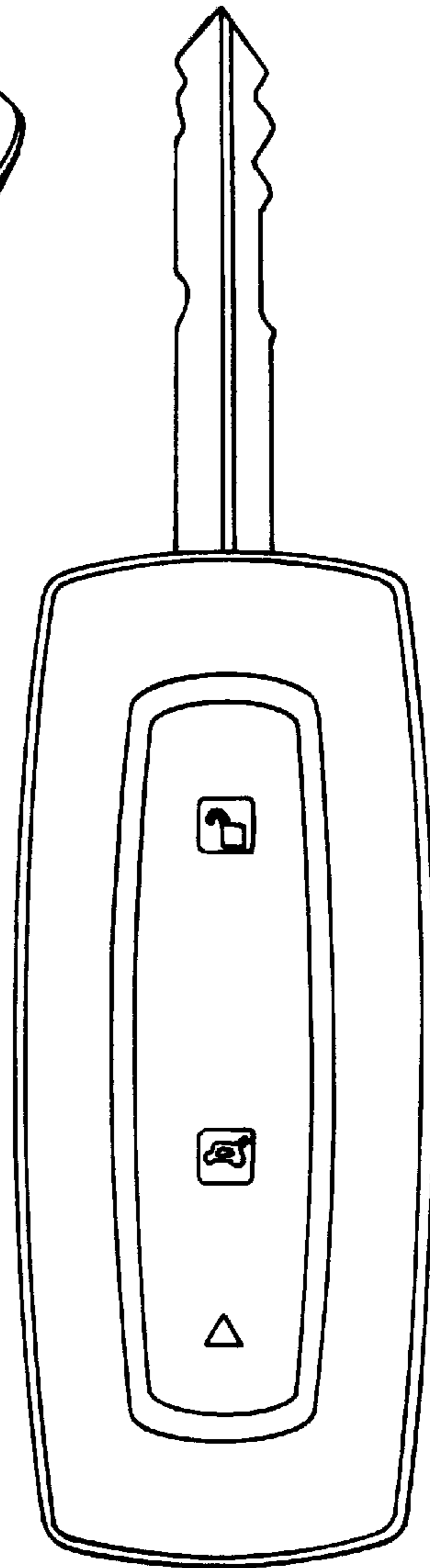

FIG. 3

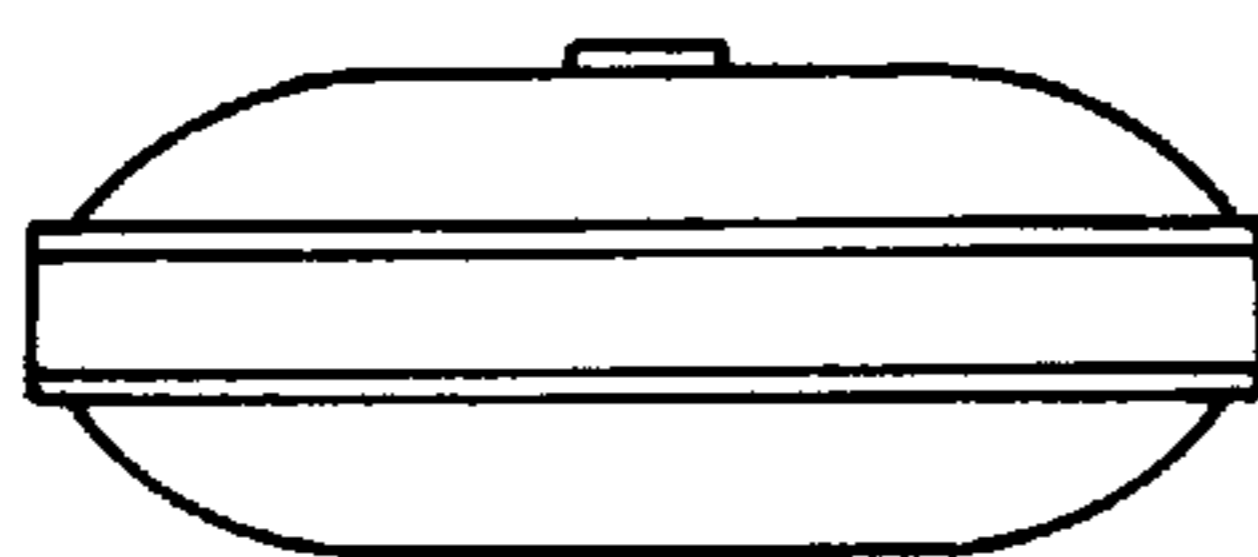

FIG. 4

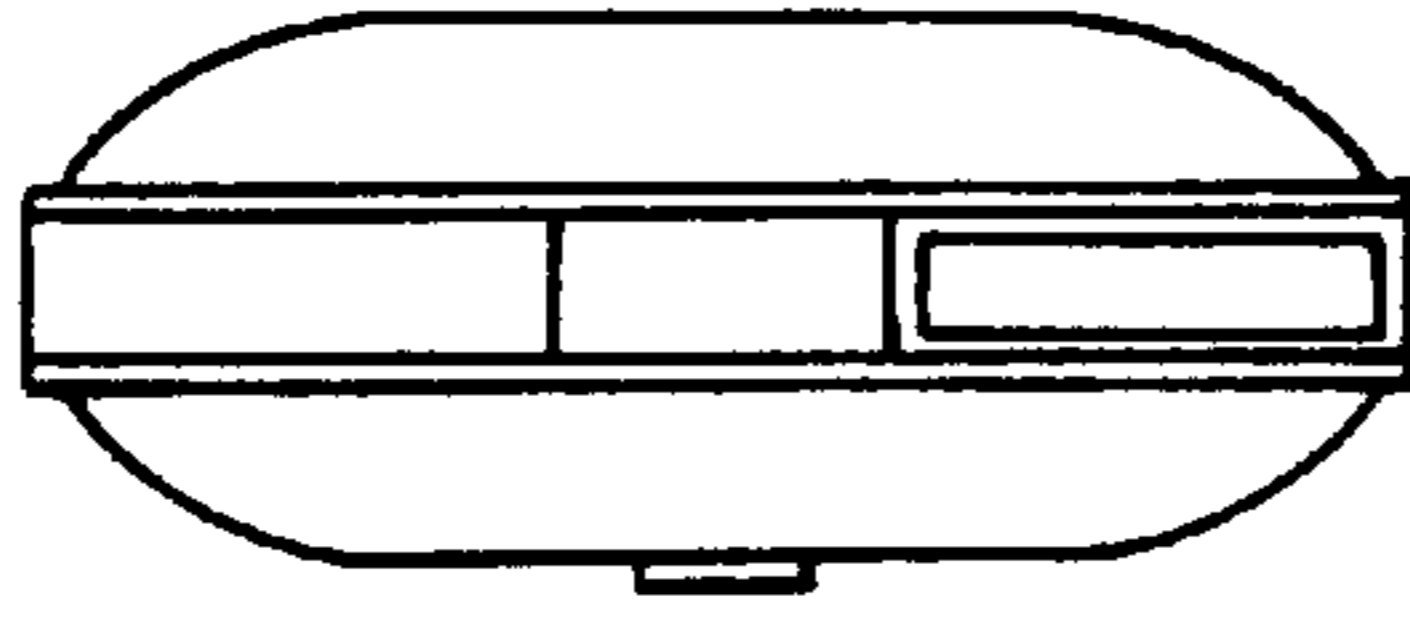

FIG. 5

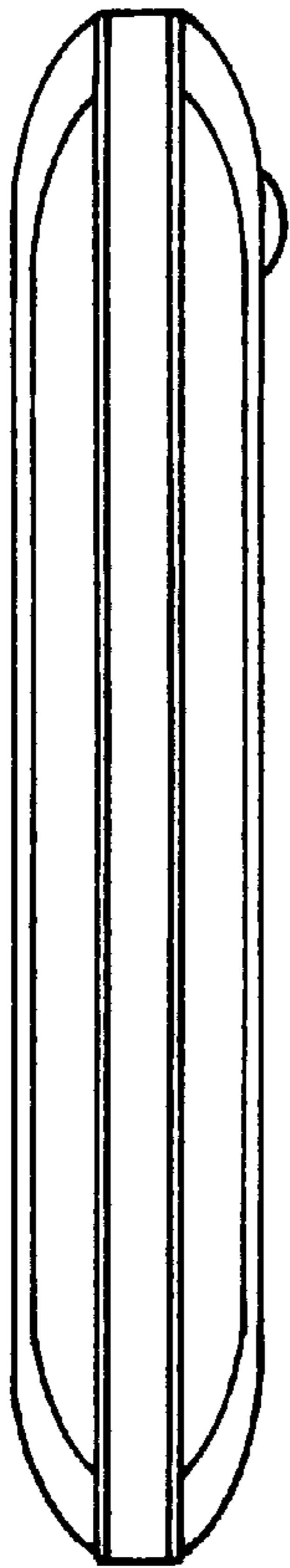

FIG. 6

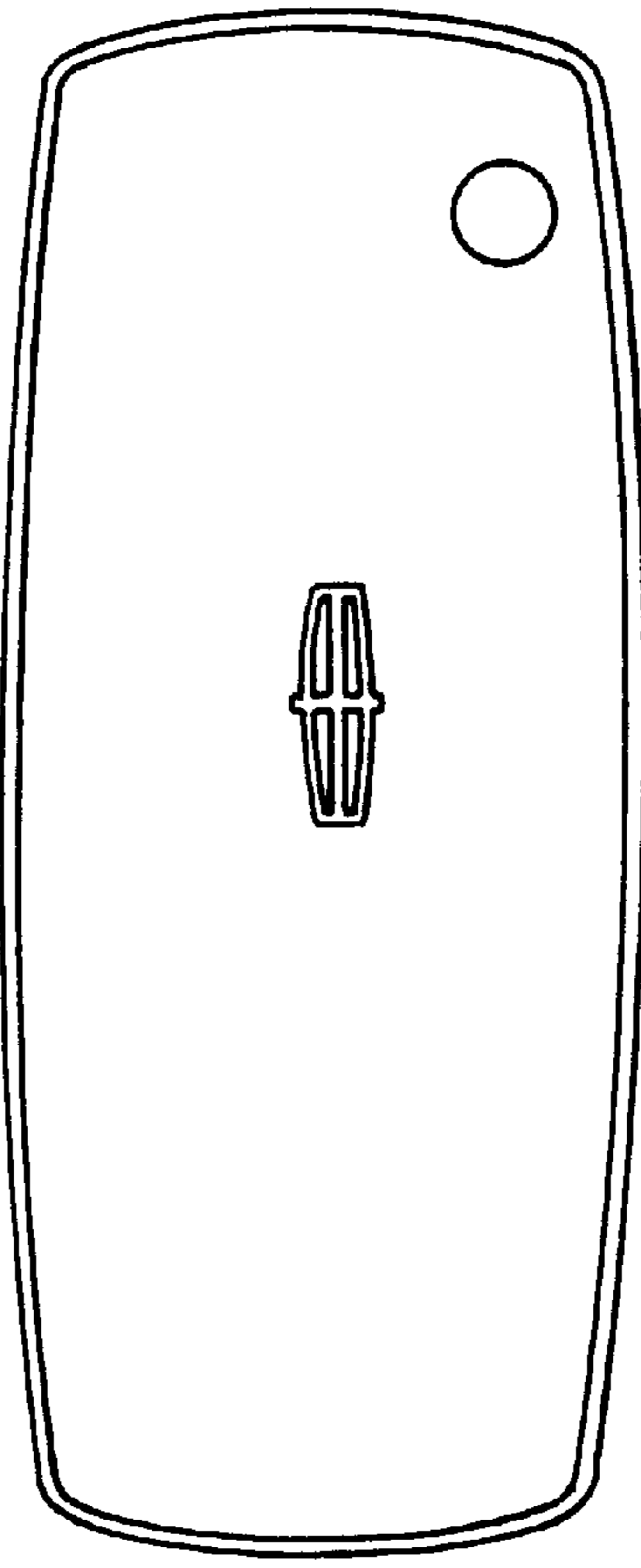

FIG. 7

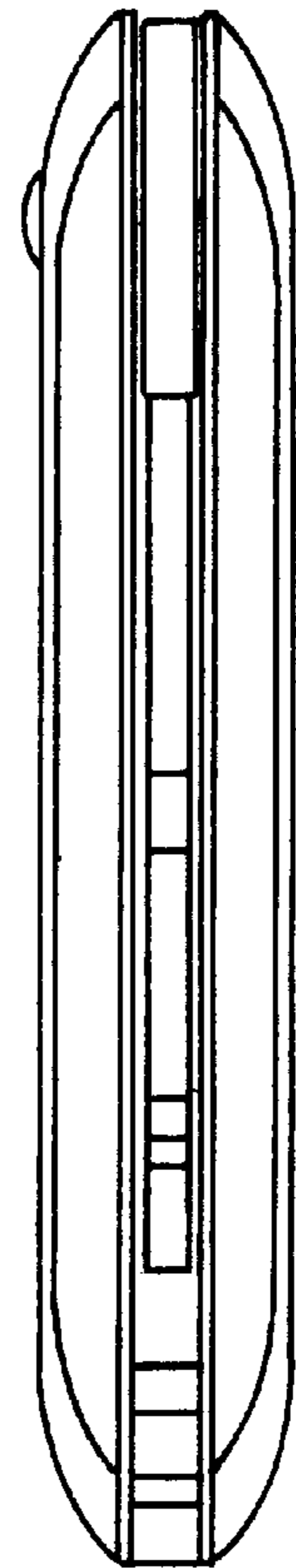

FIG. 8