



US00D442026S

(12) **United States Design Patent**
Rae

(10) **Patent No.:** **US D442,026 S**

(45) **Date of Patent:** **** May 15, 2001**

(54) **HANDLE FOR AN ARTICLE OF COOKWARE**

(75) Inventor: **Robert Allan Rae**, Kowloon (HK)

(73) Assignee: **Meyer Manufacturing Company Limited**, Kowloon (HK)

(**) Term: **14 Years**

(21) Appl. No.: **29/126,230**

(22) Filed: **Jul. 13, 2000**

(51) **LOC (7) Cl.** **07-02**

(52) **U.S. Cl.** **D7/395**

(58) **Field of Search** D7/354-361, 393-395,
D7/401.2; 220/752, 755, 769

(56) **References Cited**

U.S. PATENT DOCUMENTS

D. 164,535 * 9/1951 Wagoner D7/664

D. 337,694 * 7/1993 Hacker et al. D7/395

D. 417,121 * 11/1999 Brunianyn D7/395

* cited by examiner

Primary Examiner—Caron D. Veynar
(74) *Attorney, Agent, or Firm*—Finnegan, Henderson, Farabow, Garrett & Dunner, L.L.P.

(57) **CLAIM**

The ornamental design for an handle for an article of cookware, as shown and described.

DESCRIPTION

FIG. 1 is a perspective view of an handle for an article of cookware showing my new design;
FIG. 2 is a rear elevational view thereof;
FIG. 3 is a front elevational view thereof;
FIG. 4 is a top plan view thereof;
FIG. 5 is a left side elevational view thereof;
FIG. 6 is a right side elevational view thereof; and,
FIG. 7 is a bottom plan view thereof.

The “article of cookware” shown in phantom lines depicts the environment of my new design and forms no part of the design of my invention.

1 Claim, 4 Drawing Sheets

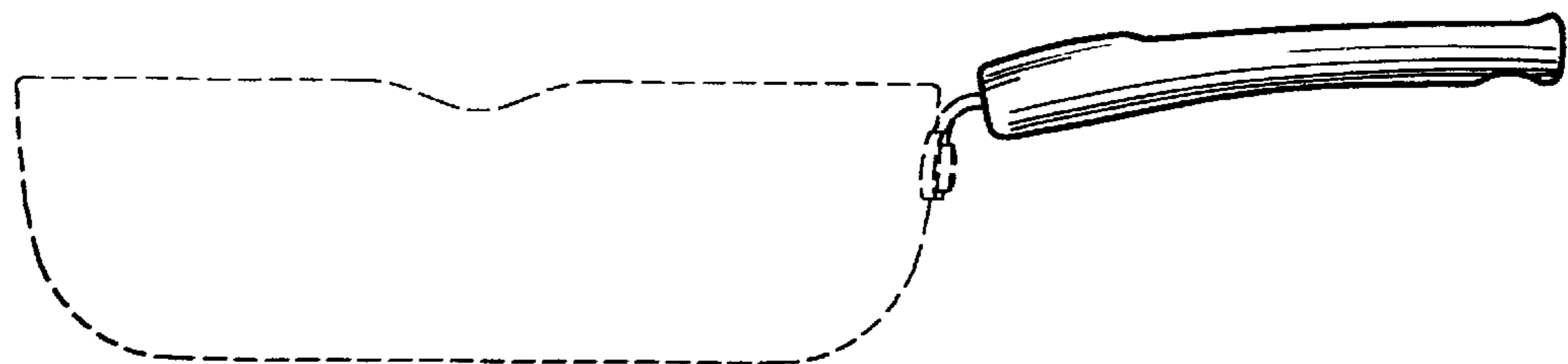
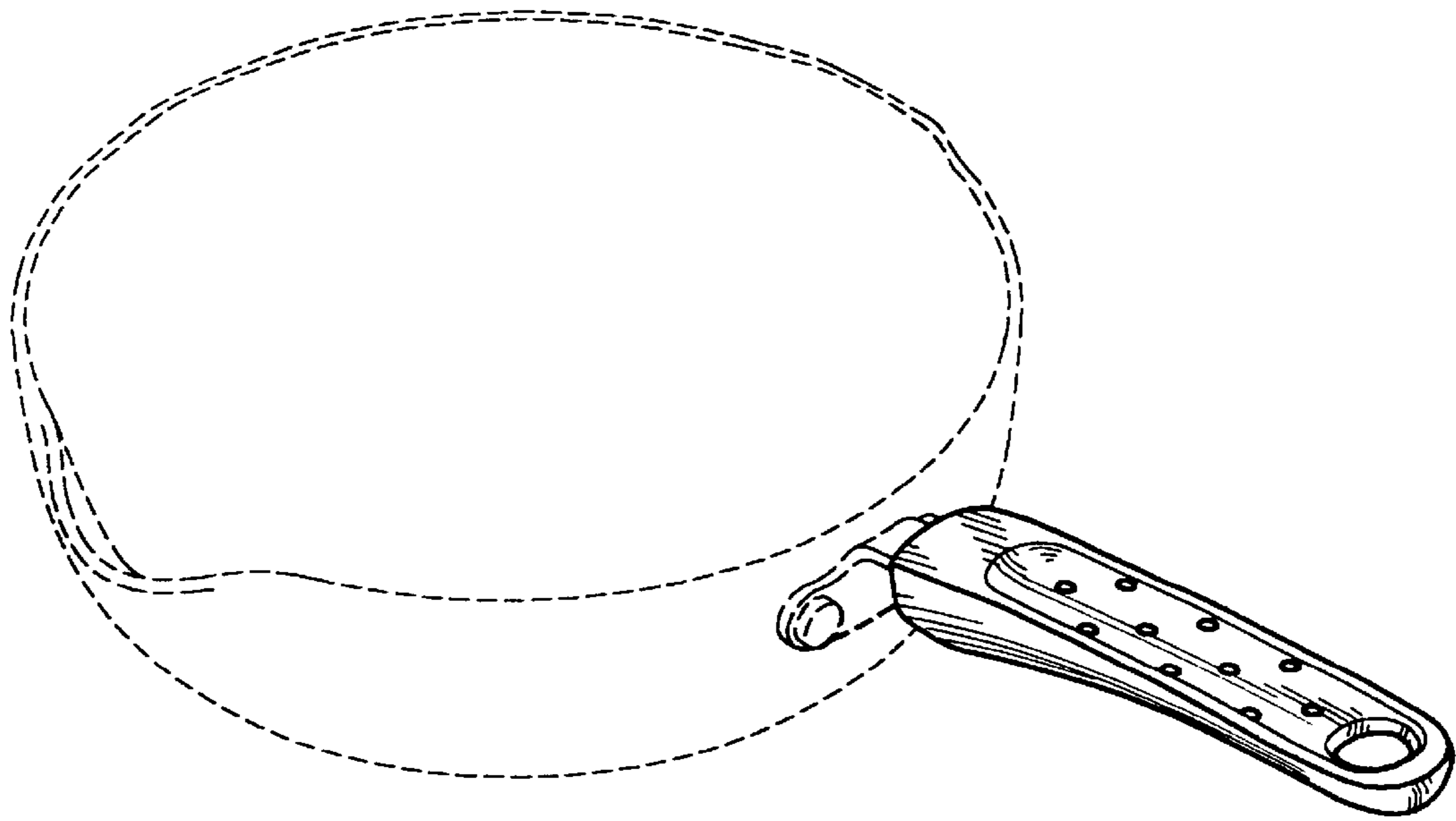

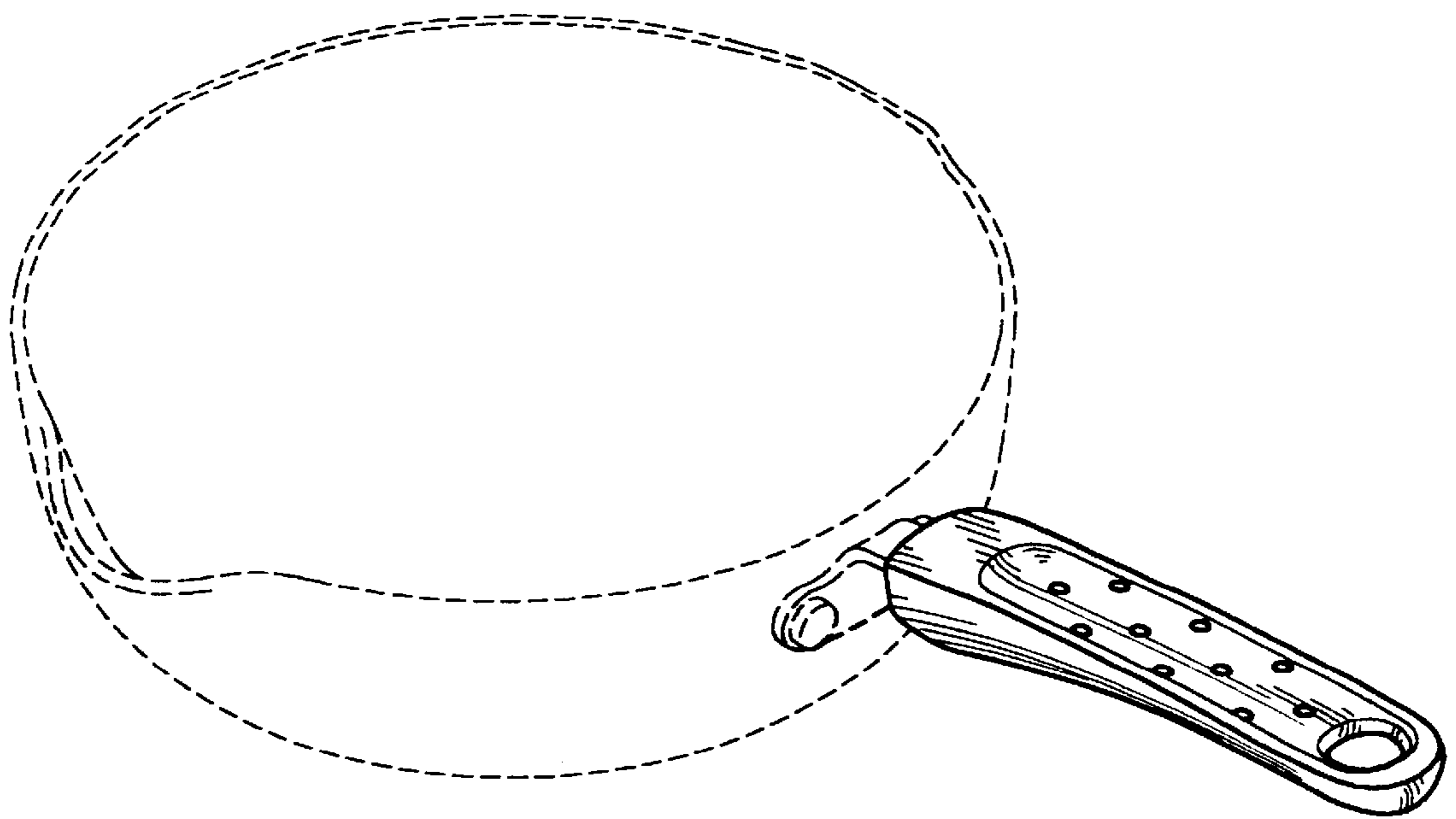

FIG. 1

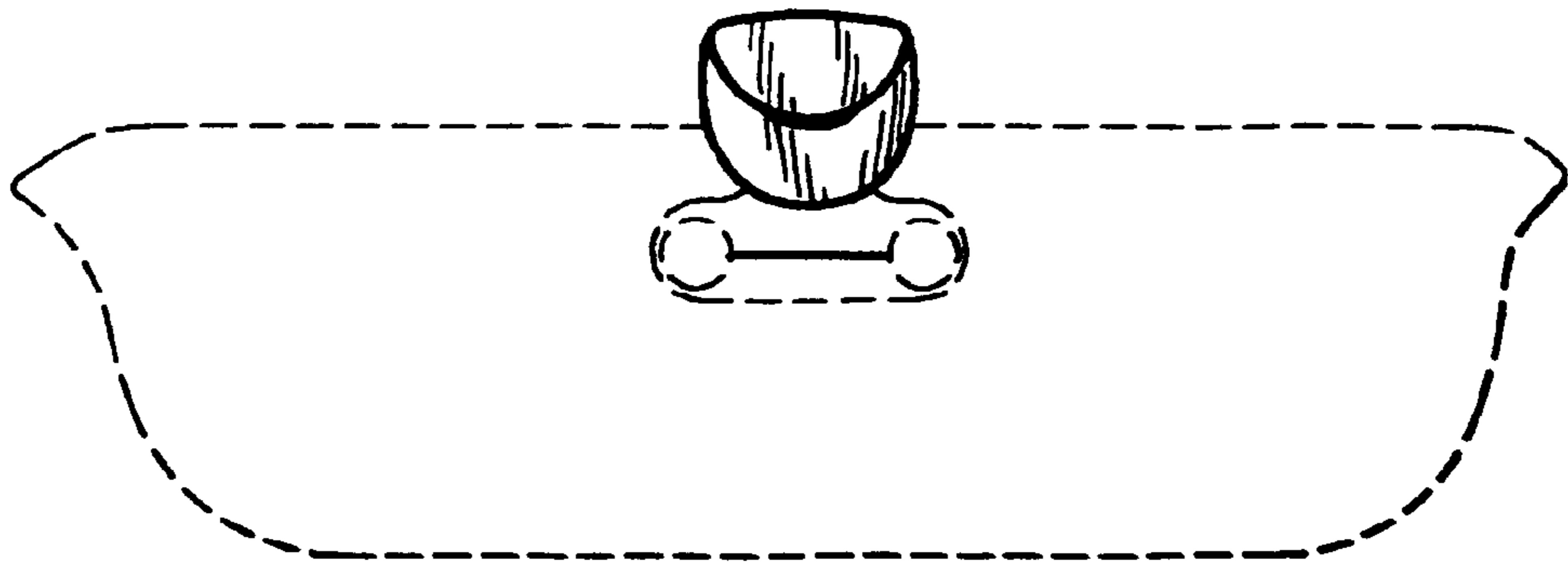

FIG. 2

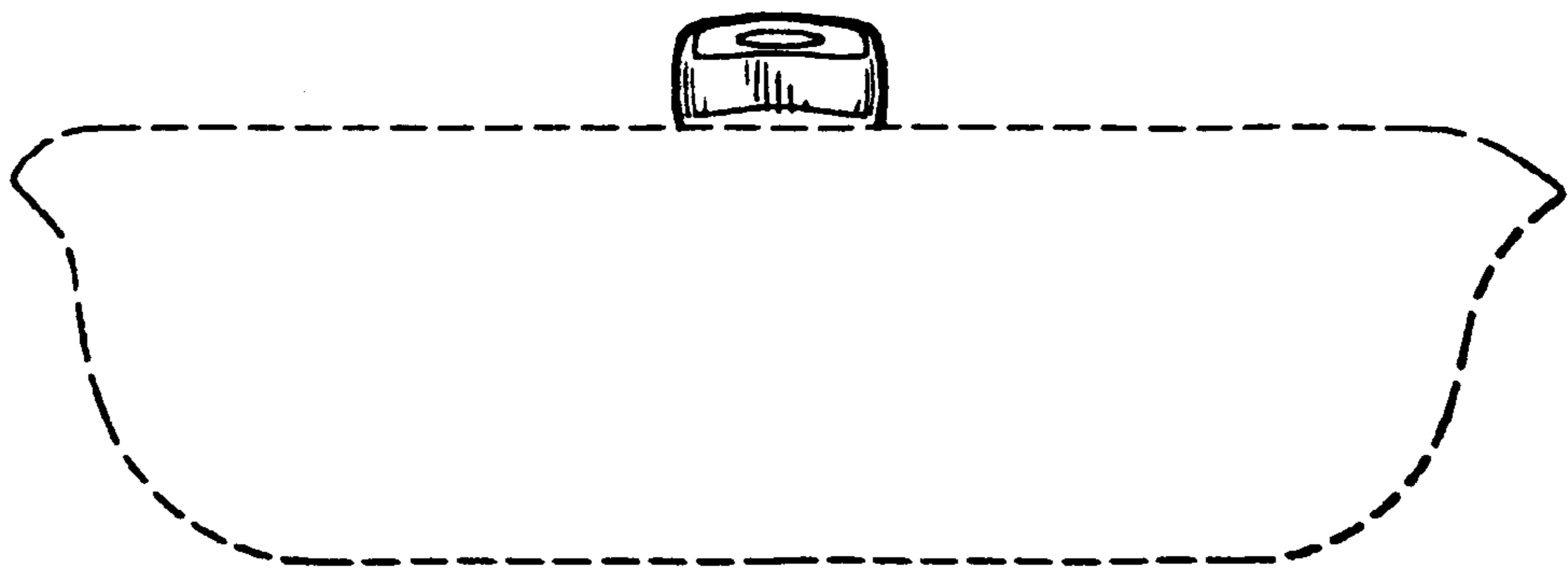

FIG. 3

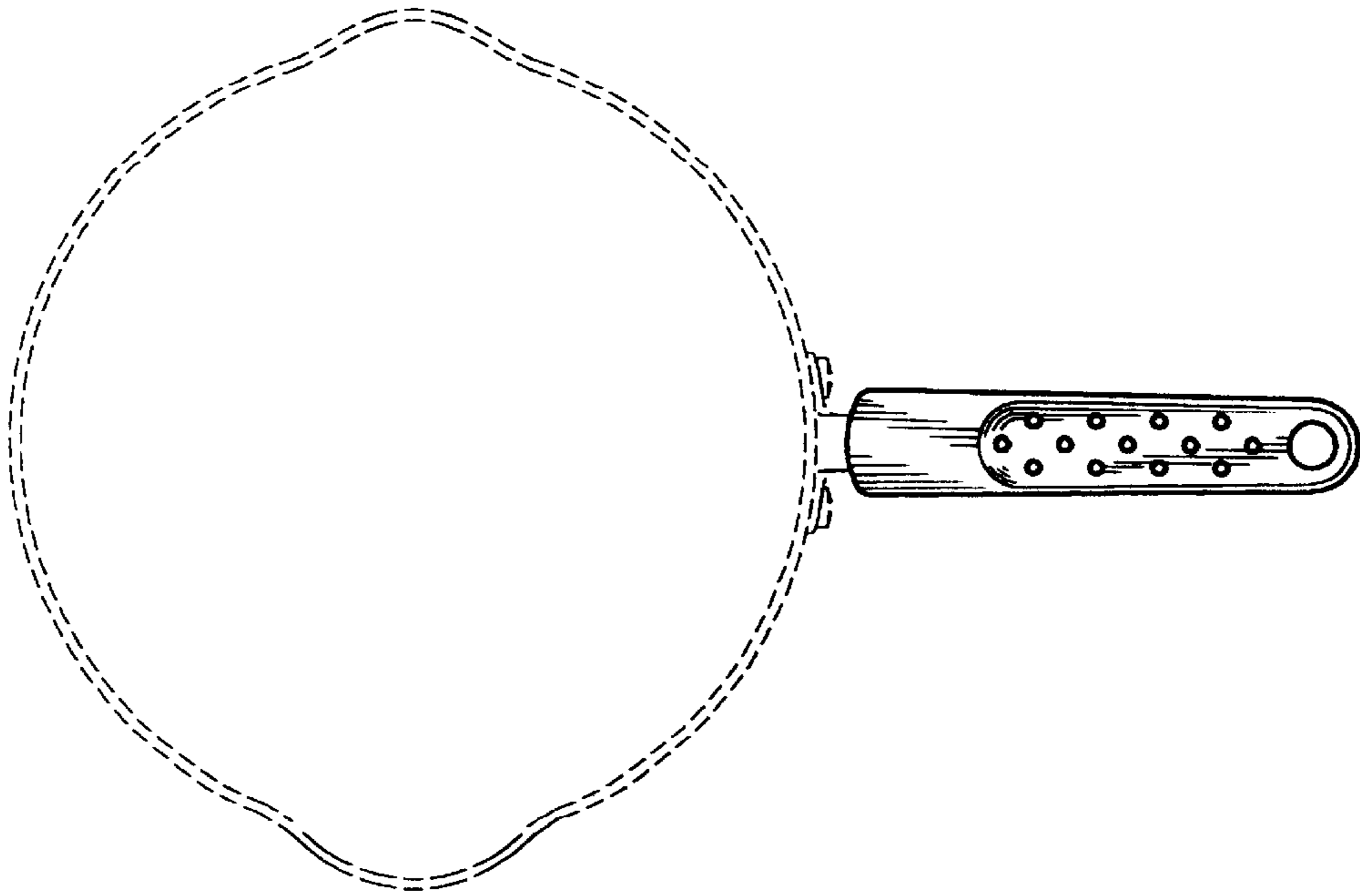

FIG. 4

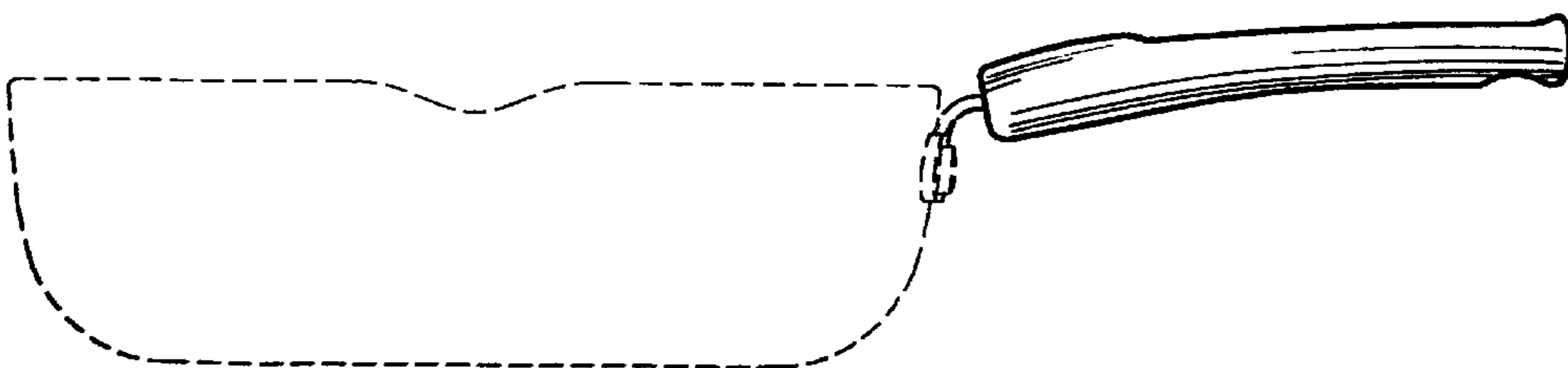

FIG. 5

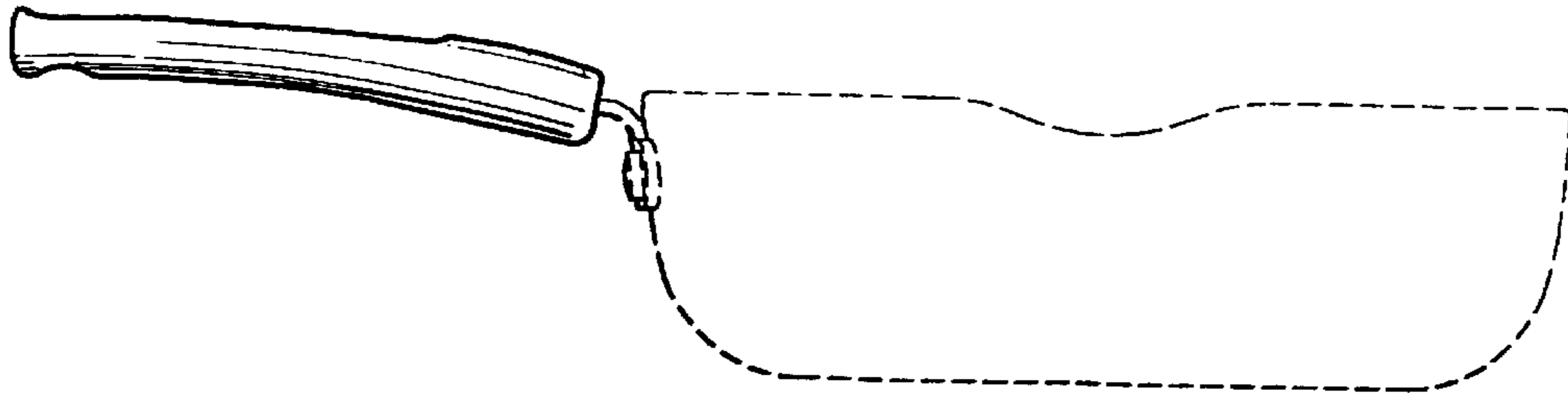

FIG. 6

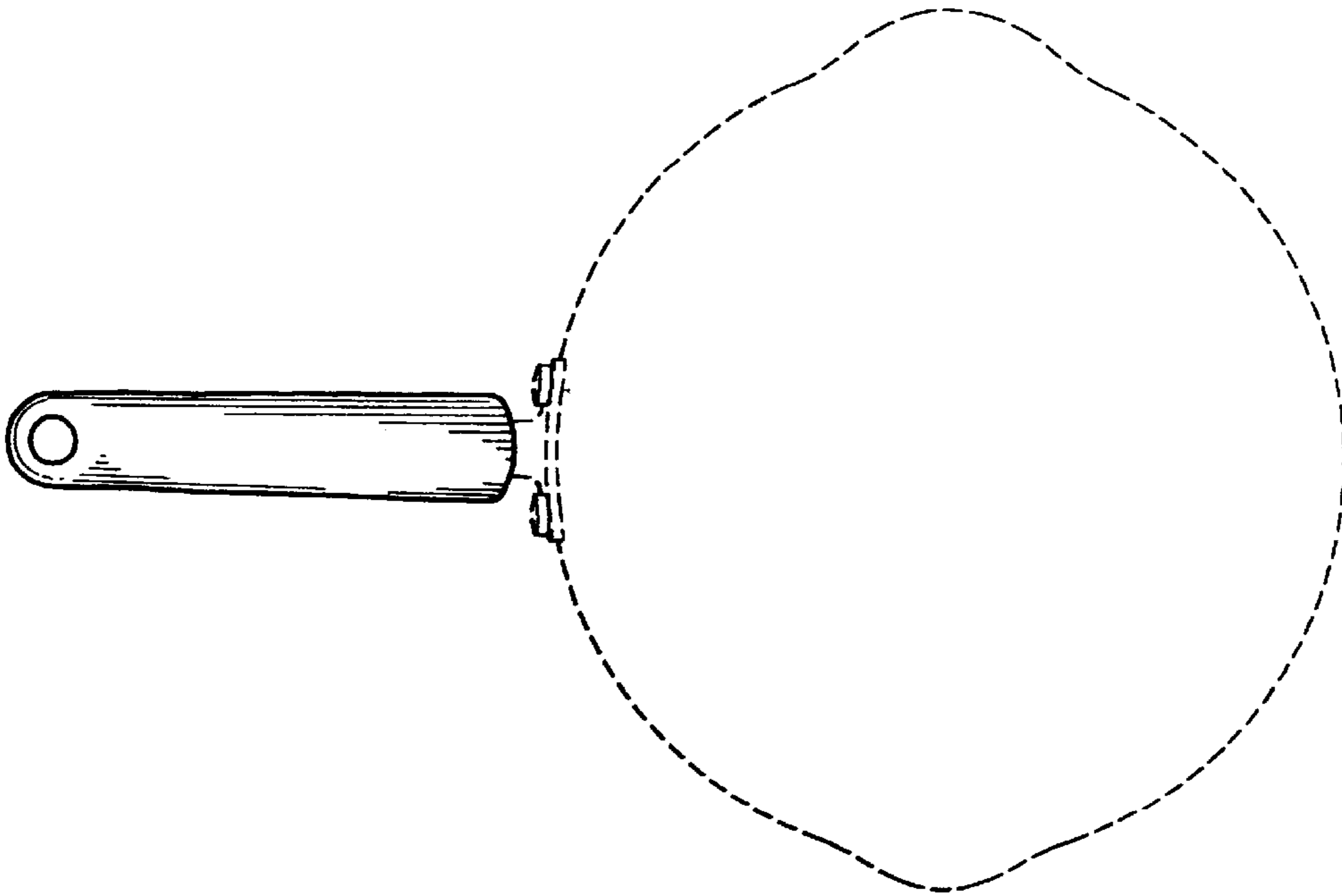

FIG. 7