



US00D441999S

(12) **United States Design Patent**
Kauzlarich et al.

(10) **Patent No.:** **US D441,999 S**

(45) **Date of Patent:** **** May 15, 2001**

(54) **SOAP CONTAINER WITH PLAIN TOP AND TOP LUG**

(75) Inventors: **John Kauzlarich**, Darien; **Brian Phillips**, Crest Hill; **A. J. Voth**, St. Charles, all of IL (US); **Jeffery E. Strickler**, Dover, PA (US)

(73) Assignee: **Gent-L-Kleen Products, Inc.**, York, PA (US)

(**) Term: **14 Years**

(21) Appl. No.: **29/120,321**

(22) Filed: **Mar. 17, 2000**

(51) **LOC (7) Cl.** **23-02**

(52) **U.S. Cl.** **D6/545**

(58) **Field of Search** D6/542-545; D9/516, D9/520, 537, 499; 206/822; 222/160, 181.1, 185.1, 206, 323, 325

(56) **References Cited**

U.S. PATENT DOCUMENTS

- D. 320,343 * 10/1991 Halm et al. D6/542 X
- D. 331,516 * 12/1992 Waring D6/545
- D. 332,544 * 1/1993 Steiner et al. D6/545
- D. 342,176 * 12/1993 Steiner et al. D6/545

- D. 404,950 * 2/1999 Burch D6/545
- 3,250,438 * 5/1966 Packwood, Jr. D6/545 X
- 4,164,306 * 8/1979 Perrin D6/545 X
- 4,848,596 * 7/1989 Rudick 222/185.1 X
- 4,886,192 * 12/1989 Cassia 222/181.1

* cited by examiner

Primary Examiner—Brian N. Vinson

(74) *Attorney, Agent, or Firm*—Emrich & Dithmar

(57) **CLAIM**

The ornamental design for the soap container with plain top and top lug, as shown and described.

DESCRIPTION

FIG. 1 is a front view of the soap container with plain top and top lug embodying our new design;
 FIG. 2 is a top view of the soap container with plain top and top lug illustrated in FIG. 1;
 FIG. 3 is a rear view of the soap container with plain top and top lug illustrated in FIG. 1;
 FIG. 4 is a bottom view of the soap container with plain top and top lug illustrated in FIG. 1;
 FIG. 5 is a right side view of the soap container with plain top and top lug illustrated in FIG. 1; and,
 FIG. 6 is a left side view of the soap container with plain top and top lug illustrated in FIG. 1.

1 Claim, 4 Drawing Sheets

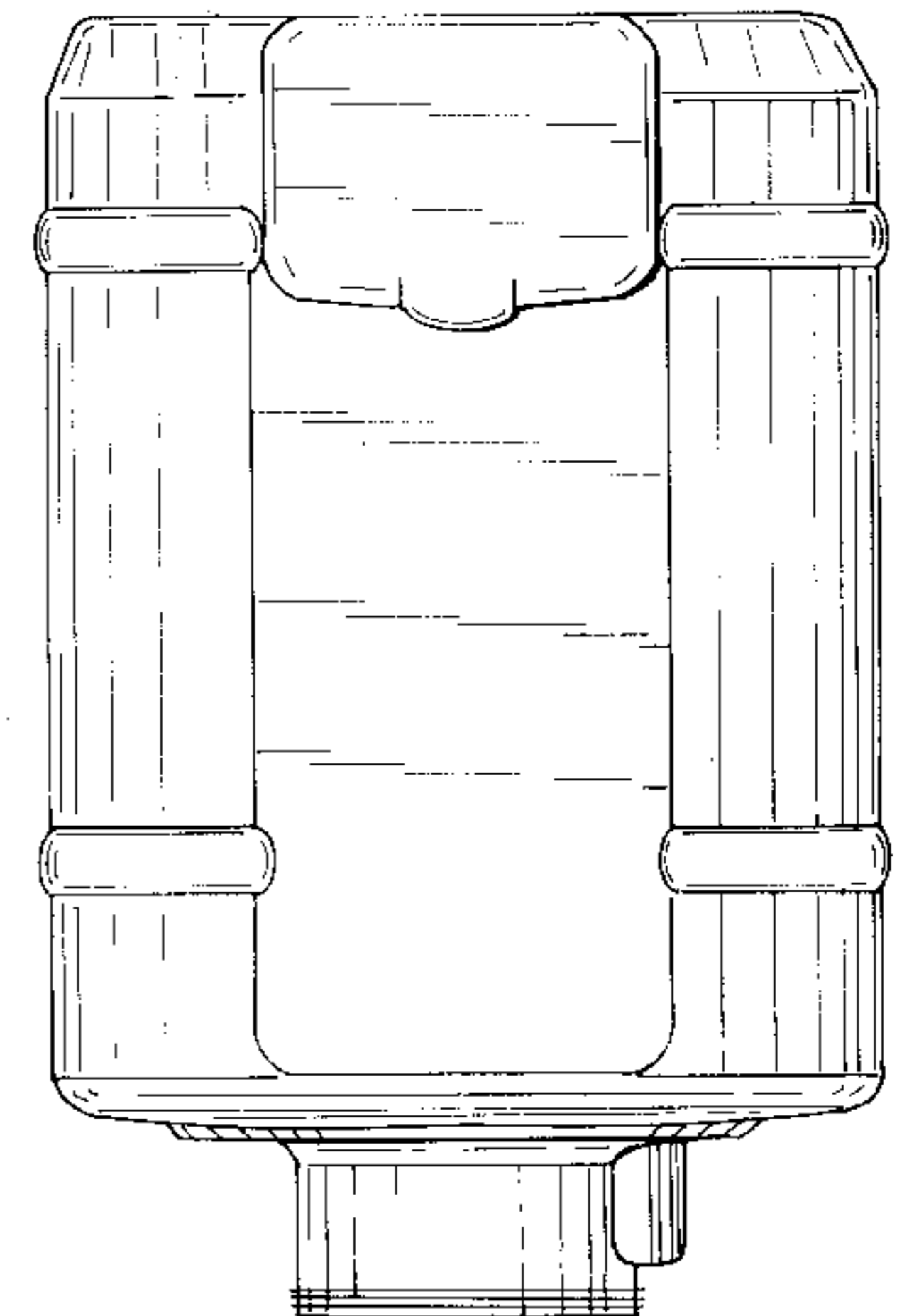
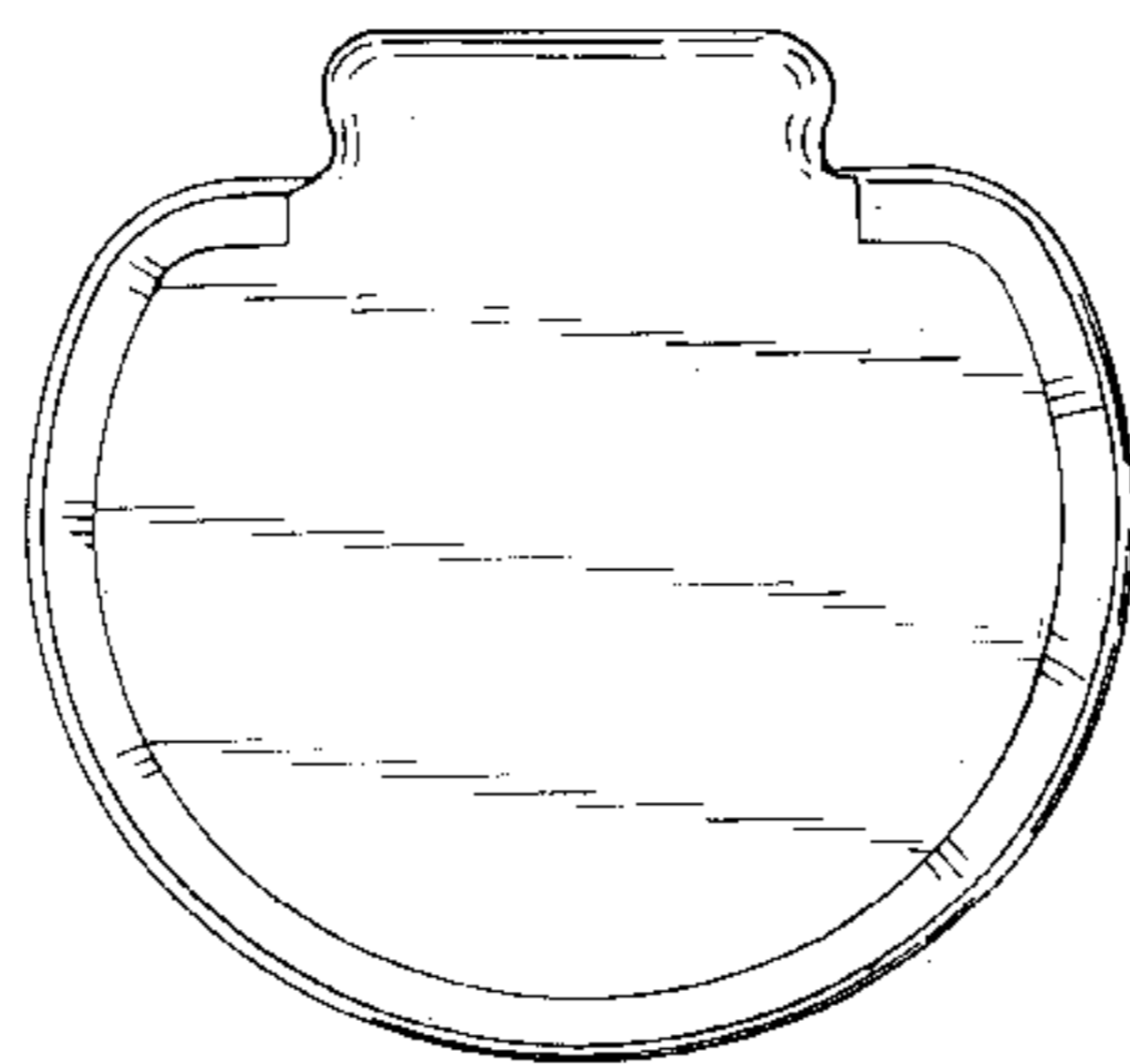
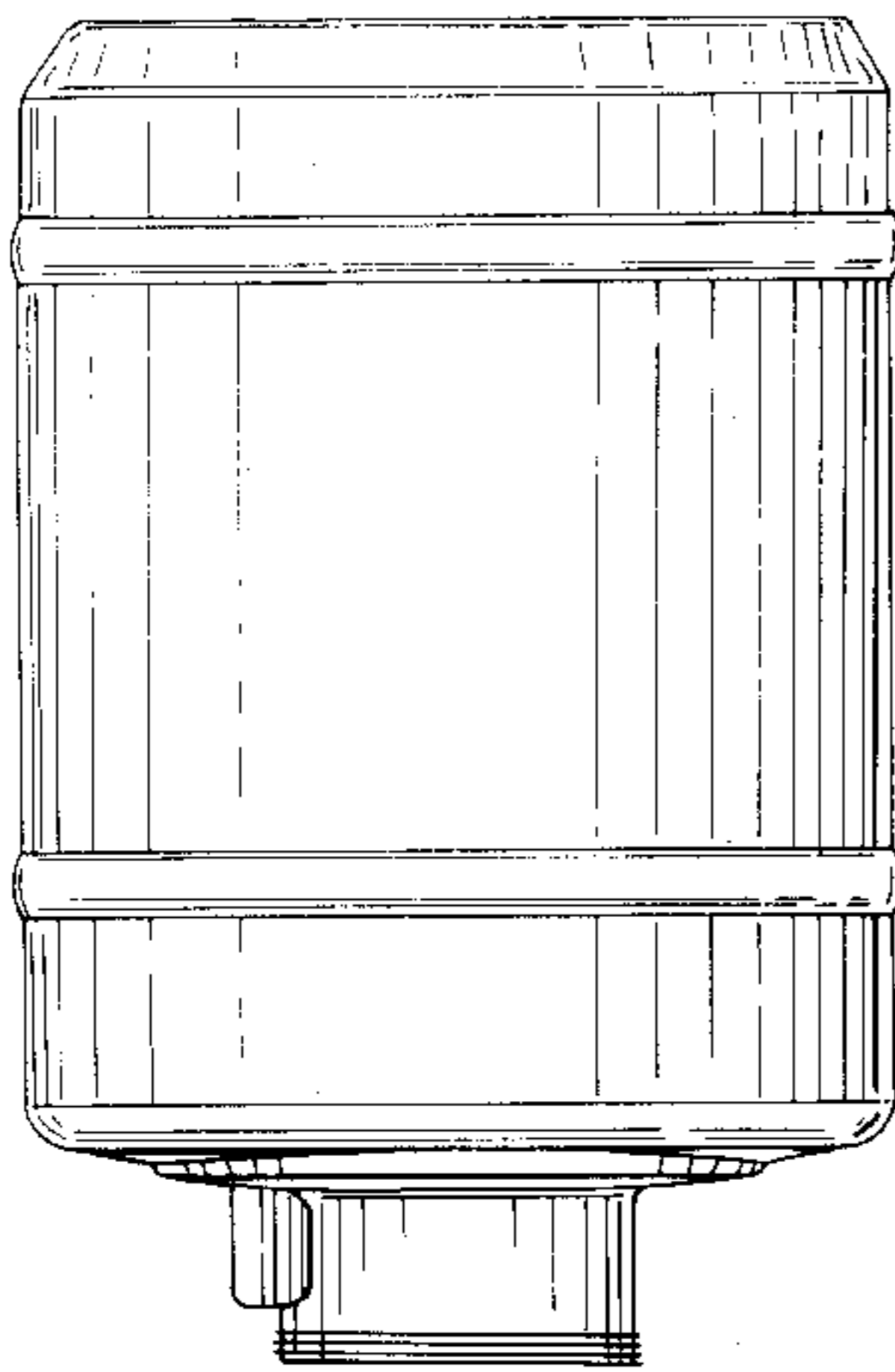

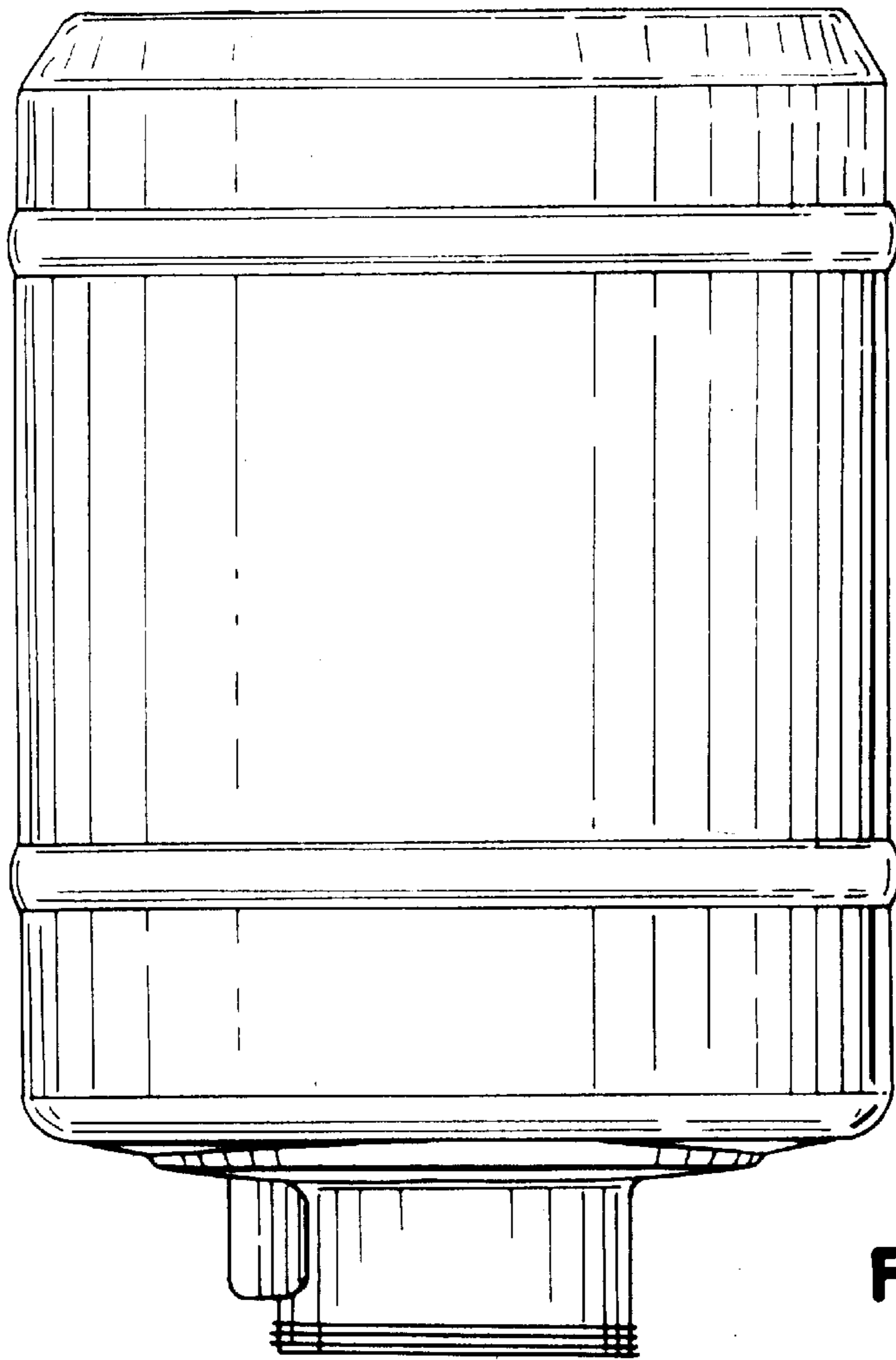

FIG. 1

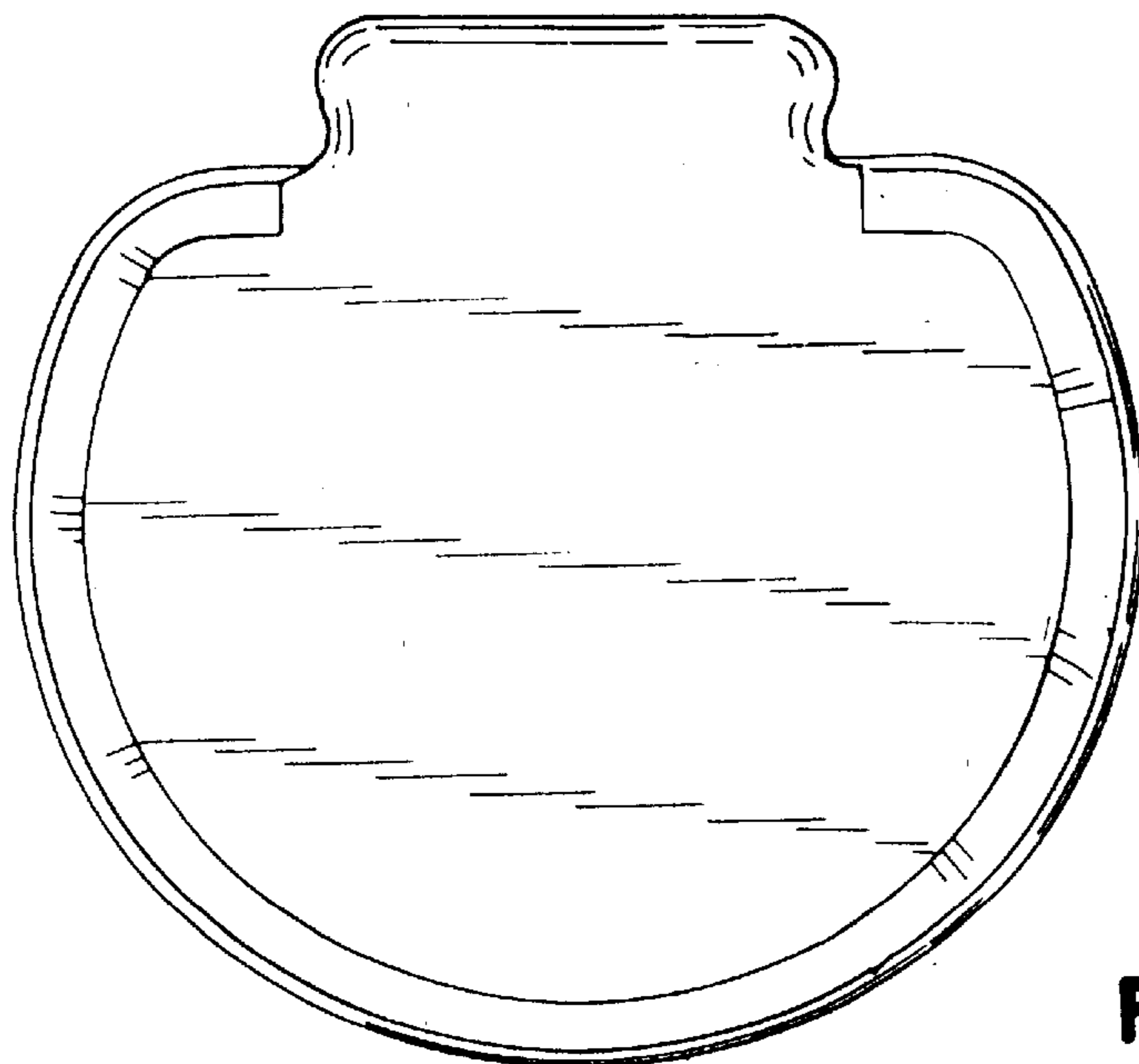

FIG. 2

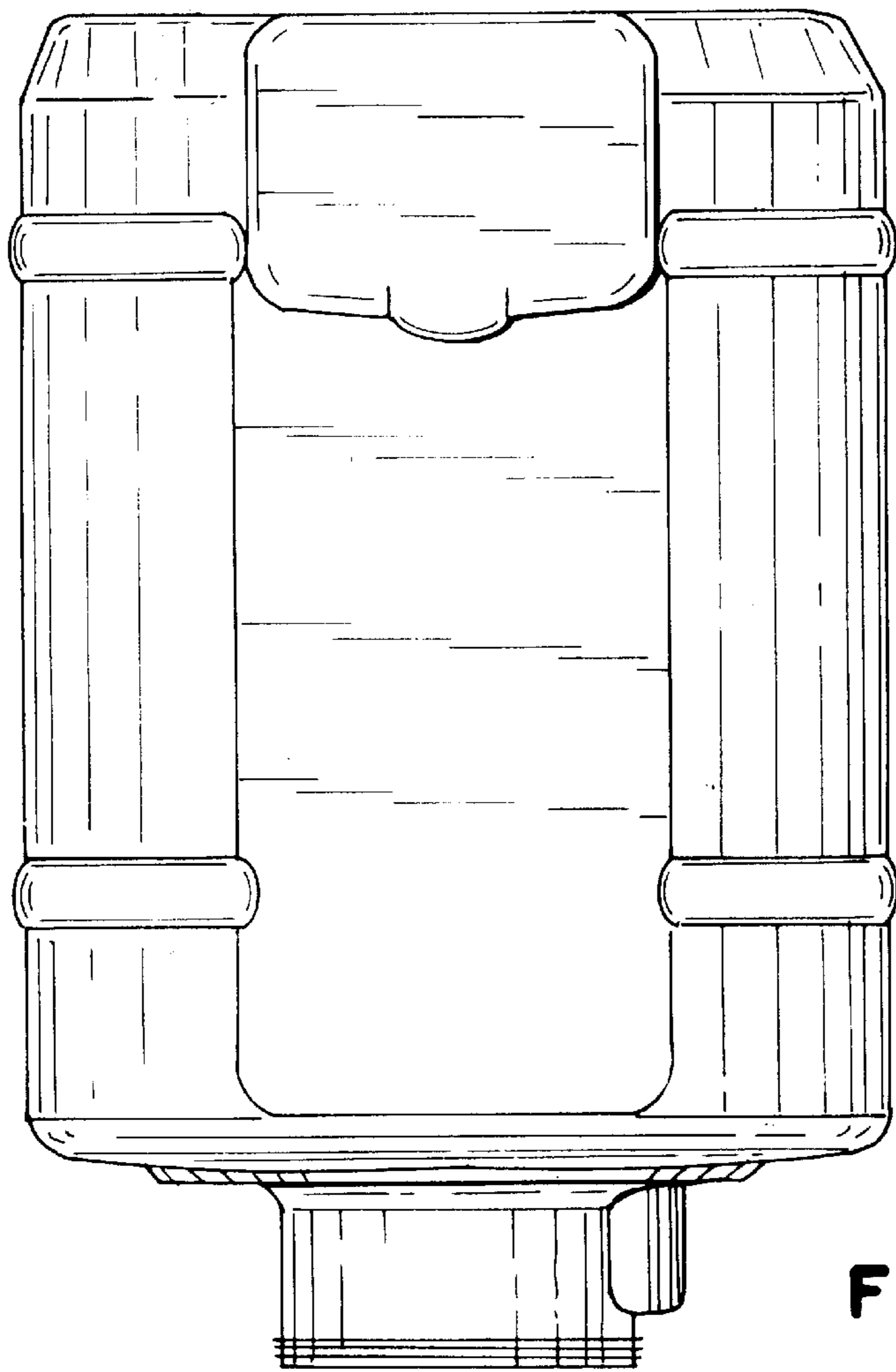

FIG. 3

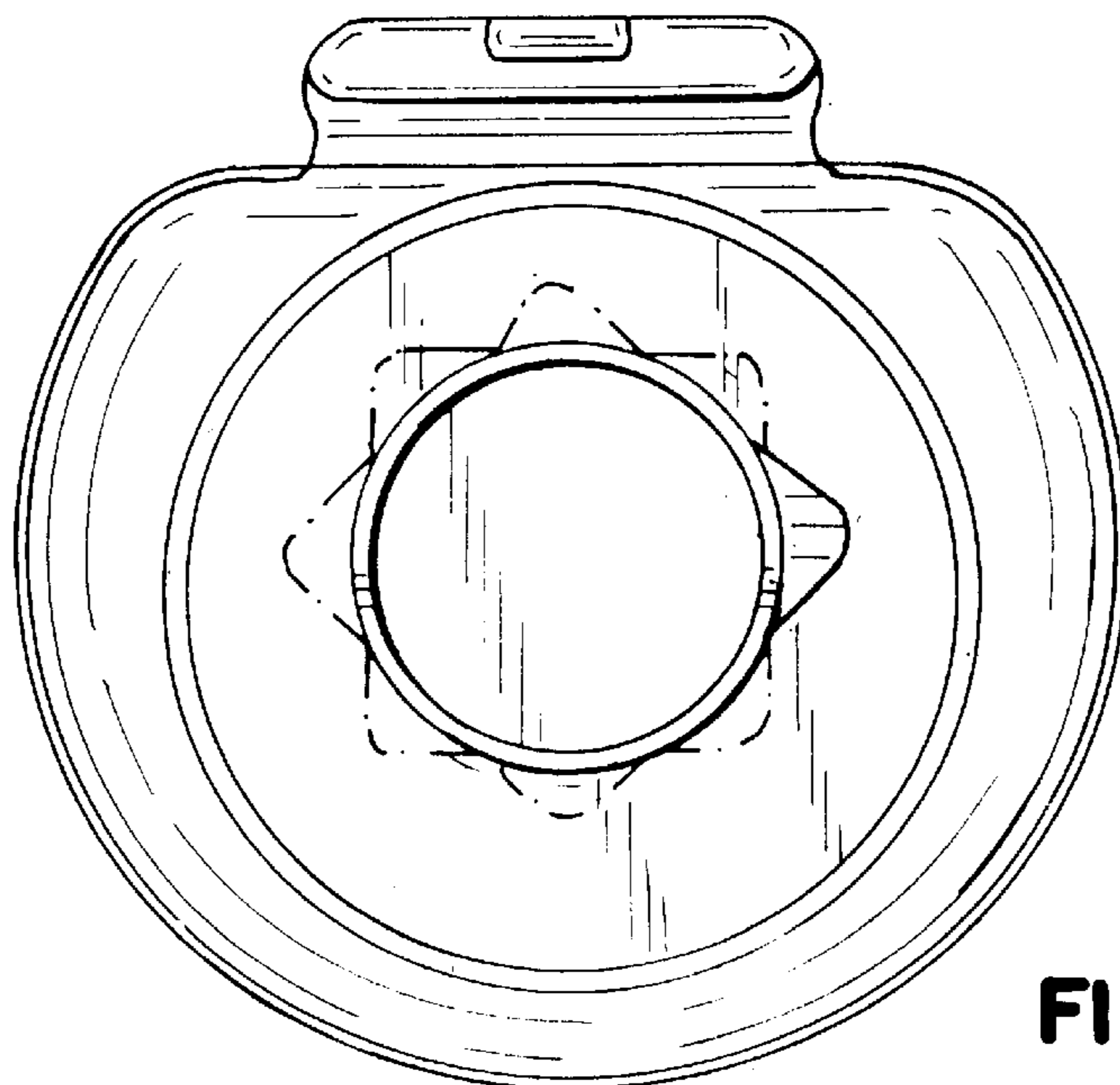

FIG. 4

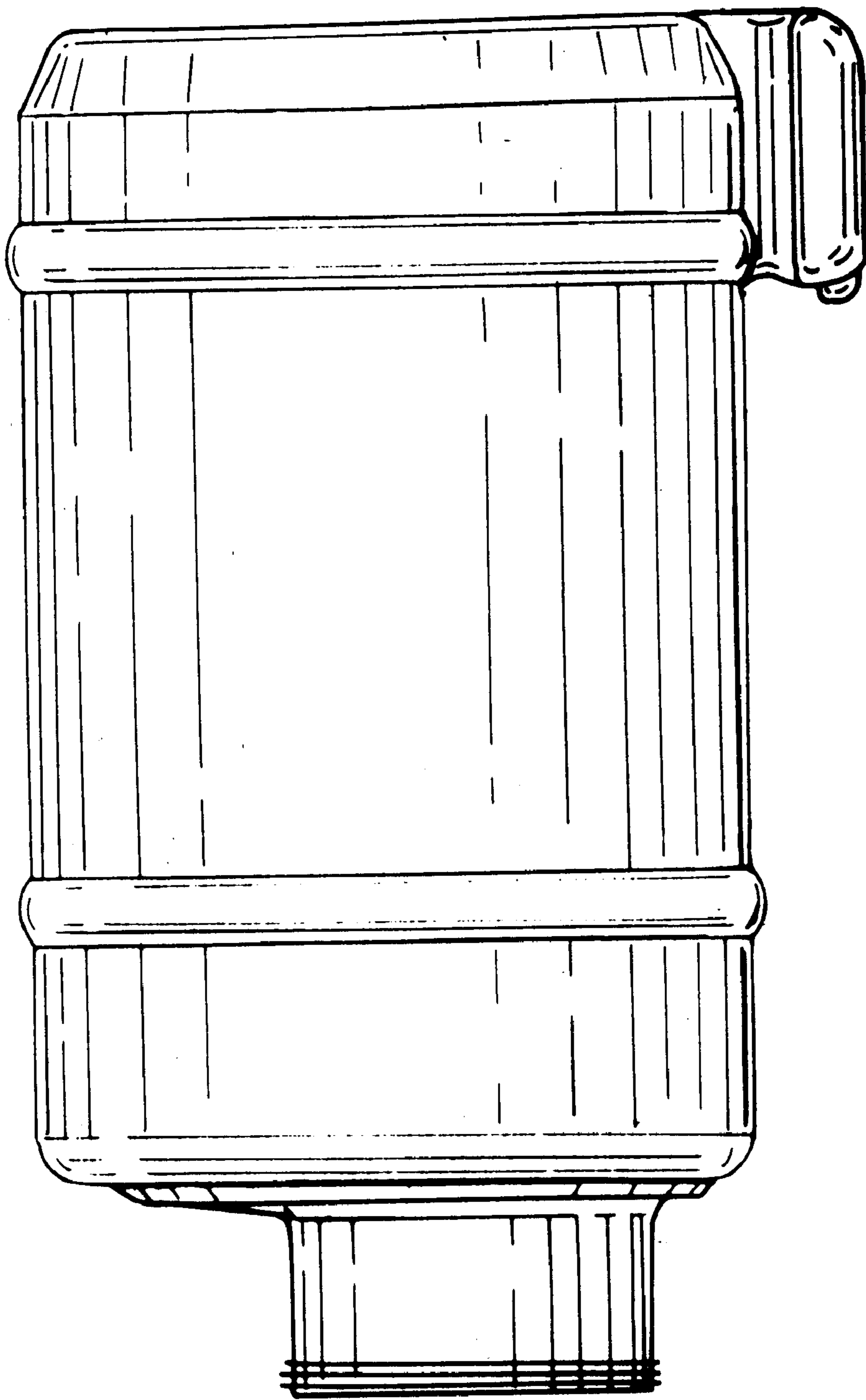

FIG. 5

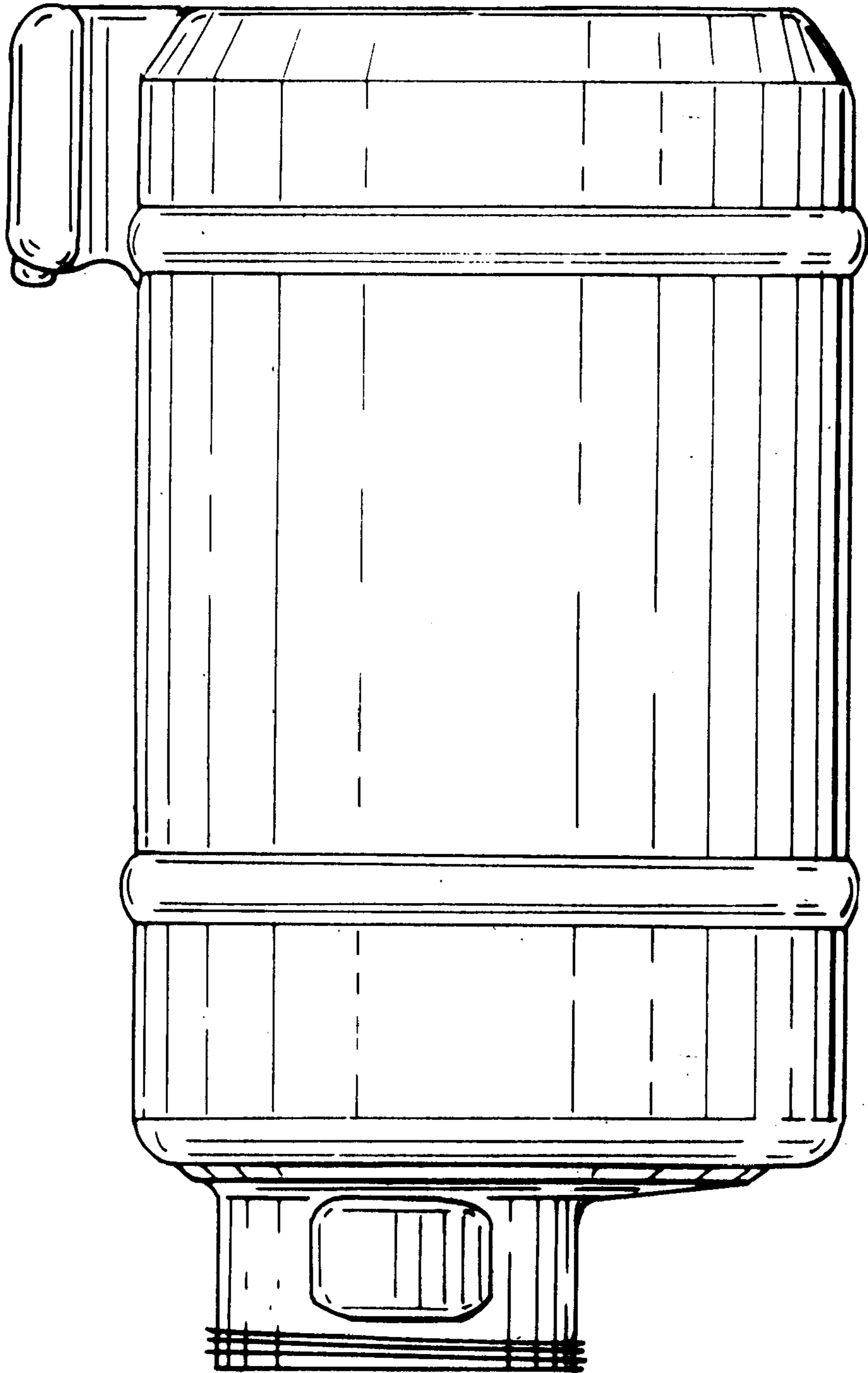

FIG. 6