



US00D441919S

(12) **United States Design Patent**
Kontos

(10) **Patent No.:** **US D441,919 S**

(45) **Date of Patent:** **** *May 8, 2001**

(54) **SAFETY HARNESS FOR RESTRAINING A CHILD IN A CAR CARRIER**

(76) **Inventor:** **George Vlasios Kontos**, 3909 Lake Des Allemands Dr., Harvey, LA (US) 70058

(*) **Notice:** This patent is subject to a terminal disclaimer.

(**) **Term:** **14 Years**

(21) **Appl. No.:** **29/111,777**

(22) **Filed:** **Oct. 4, 1999**

(51) **LOC (7) Cl.** **30-04**

(52) **U.S. Cl.** **D29/101.3**

(58) **Field of Search** D29/100, 101, D29/122; D2/860-864; D24/190; 2/2, 2.5, 44-46, 48-52, 92, 463, 908, 913; 128/869, 872, 874-876; 602/19; 200/515.1, 516.1; D6/333, 356; 297/464, 465, 469, 484, 487, 488

(56) **References Cited**

U.S. PATENT DOCUMENTS

D. 257,646 * 12/1980 Riedell D29/101
D. 270,109 * 8/1983 Bluemel D29/100

D. 376,872 * 12/1996 Stroud D29/101
D. 391,682 * 3/1998 Palembang D29/101
D. 403,125 * 12/1998 Larsen et al. D29/111
1,616,349 * 2/1927 Cagle 297/465
2,252,357 * 8/1941 Shaw D29/101
2,758,595 * 8/1956 Lovett D29/101
4,330,152 * 5/1982 Legan et al. 297/465

* cited by examiner

Primary Examiner—Louis S. Zarfaz

Assistant Examiner—Robert A. Delehanty

(74) *Attorney, Agent, or Firm*—Shawn David Sentilles

(57) **CLAIM**

The ornamental design for a safety harness for restraining a child in a car carrier, as shown.

DESCRIPTION

FIG. 1 is a front elevation view of the preferred design of a safety harness for restraining a child in a car carrier showing my new design;

FIG. 2 is a rear elevational view thereof;

FIG. 3 is the left side elevational view thereof;

FIG. 4 is the right side elevational view thereof;

FIG. 5 is the top side elevational view thereof; and,

FIG. 6 is the bottom side elevational view thereof.

1 Claim, 3 Drawing Sheets

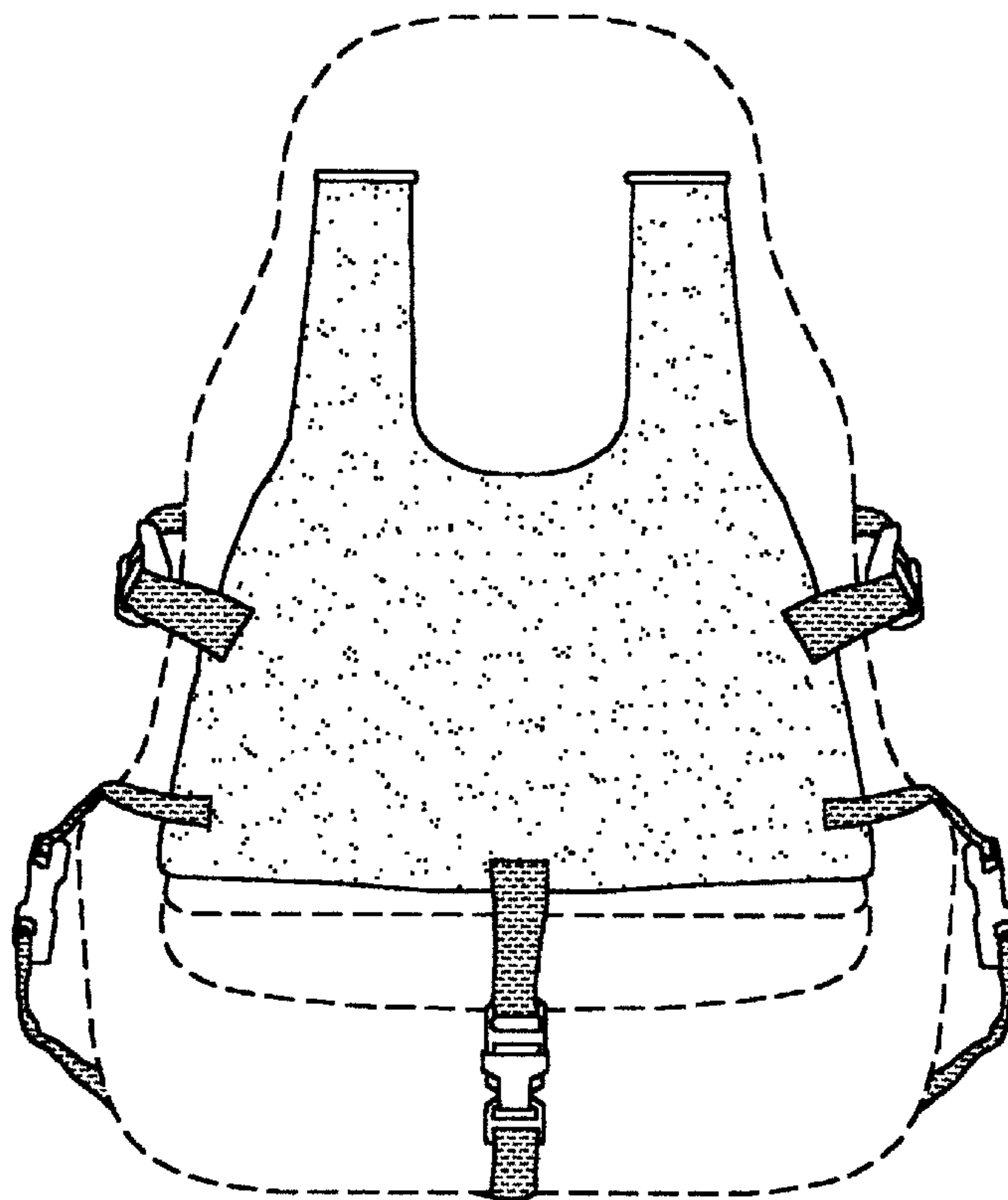

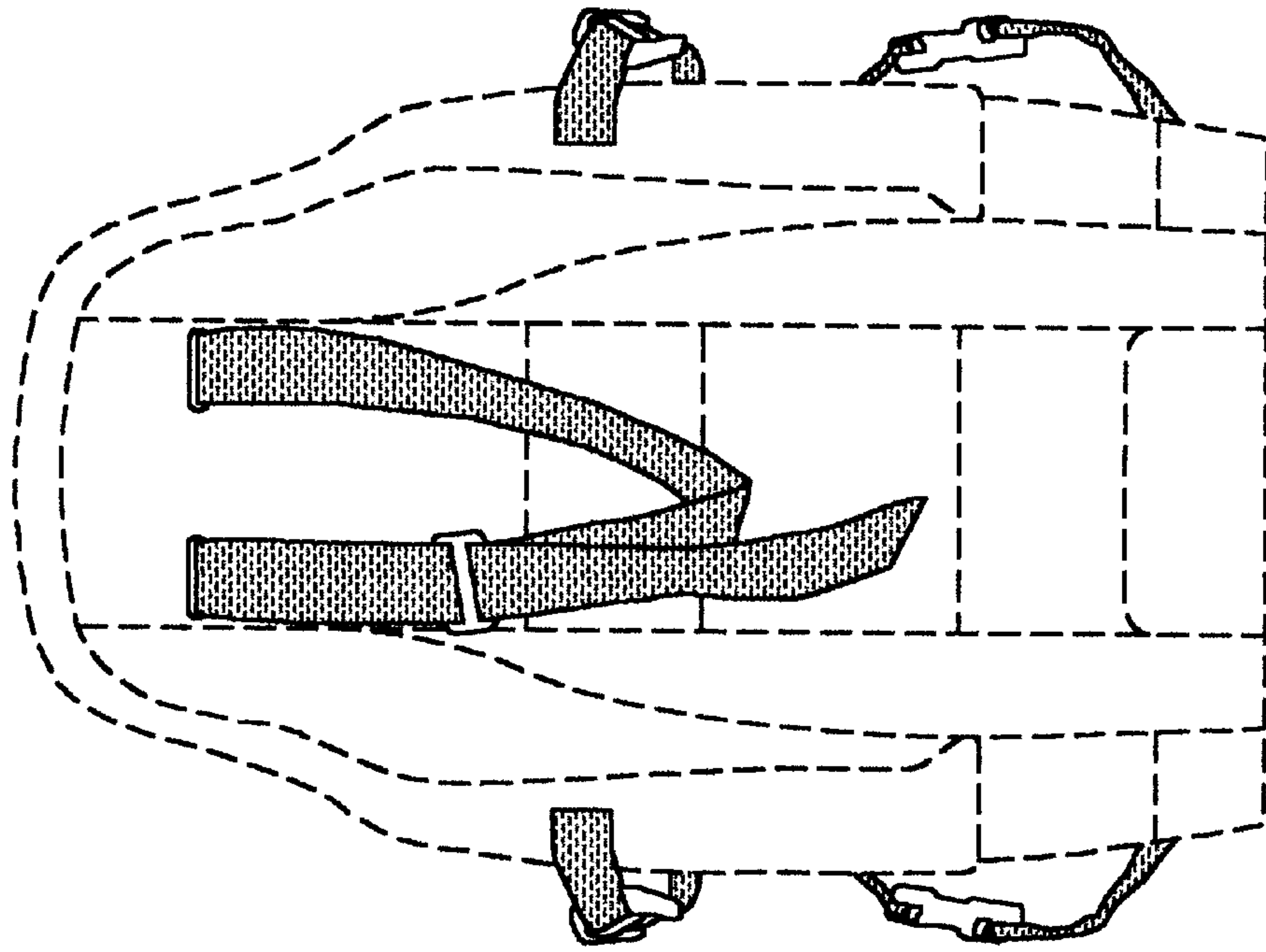

FIG. 2

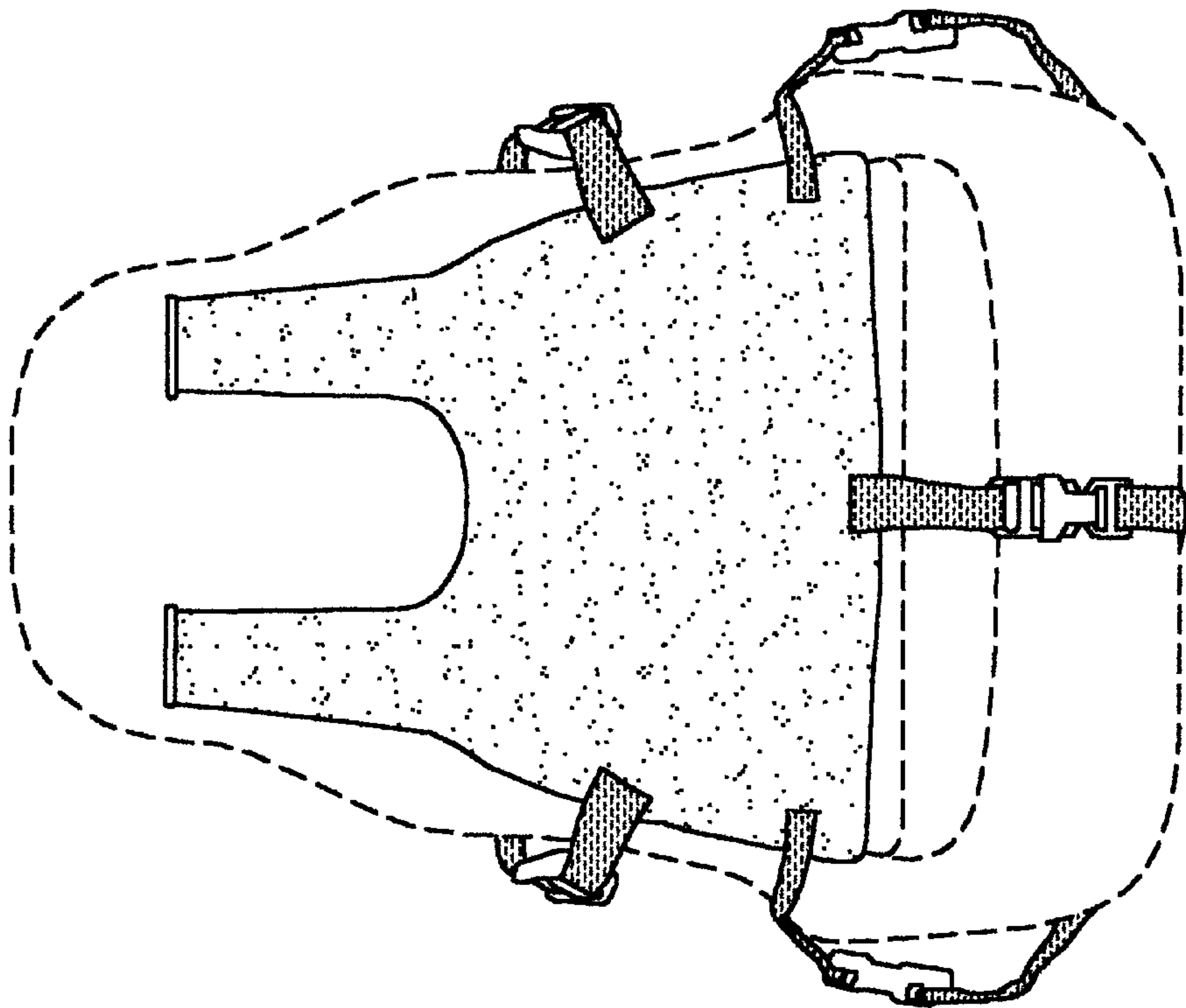

FIG. 1

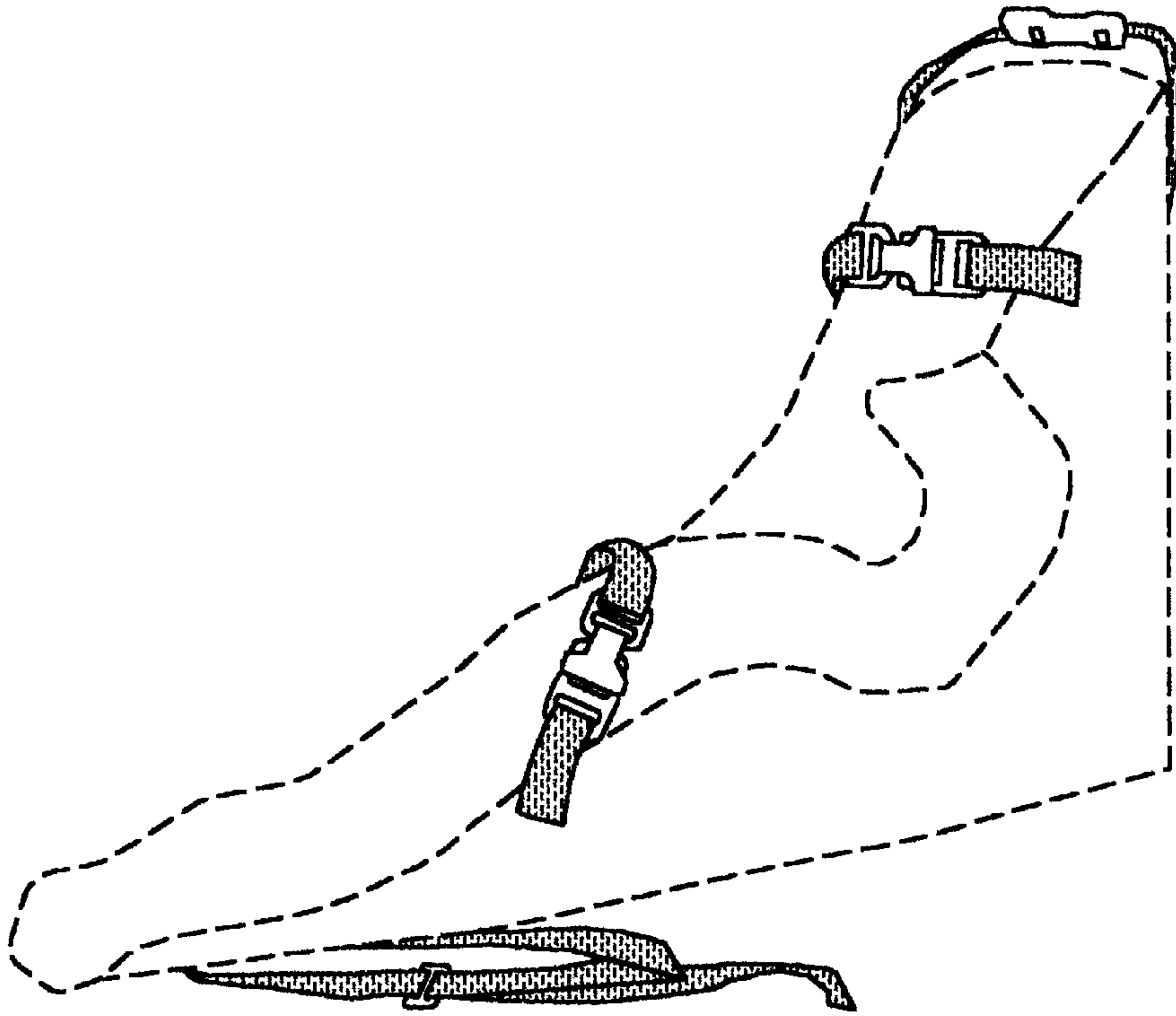

FIG. 4

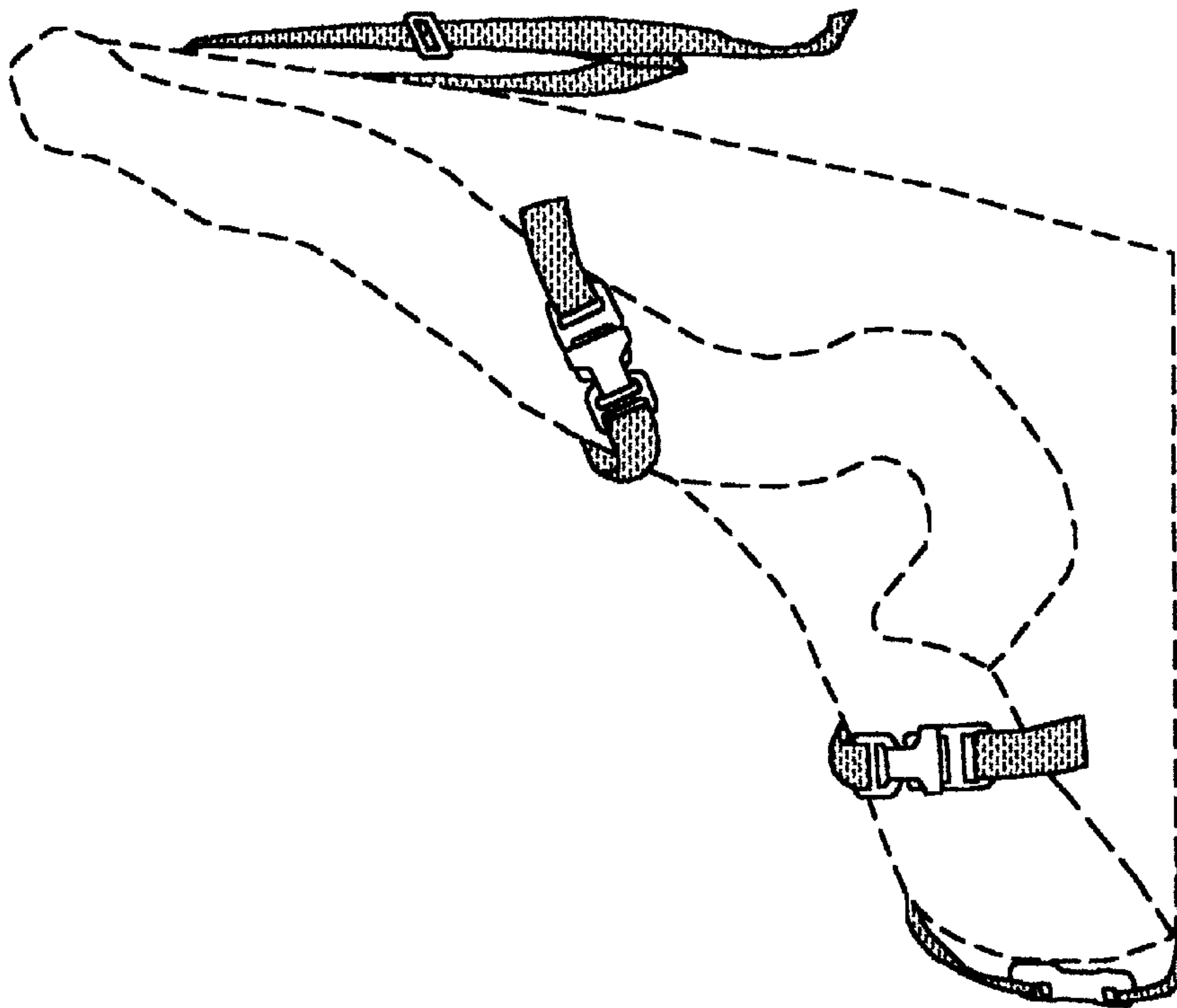

FIG. 3

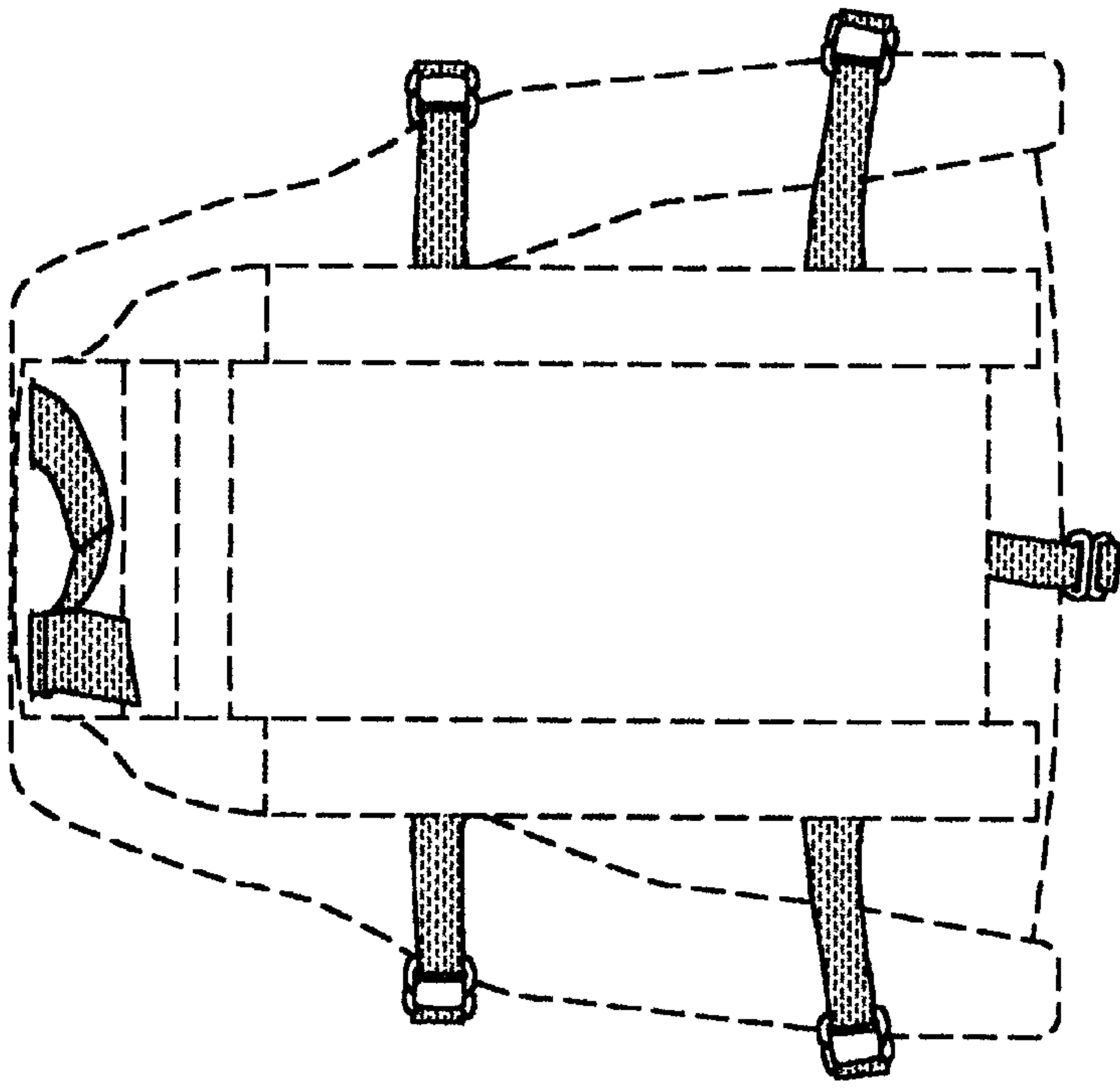

FIG. 6

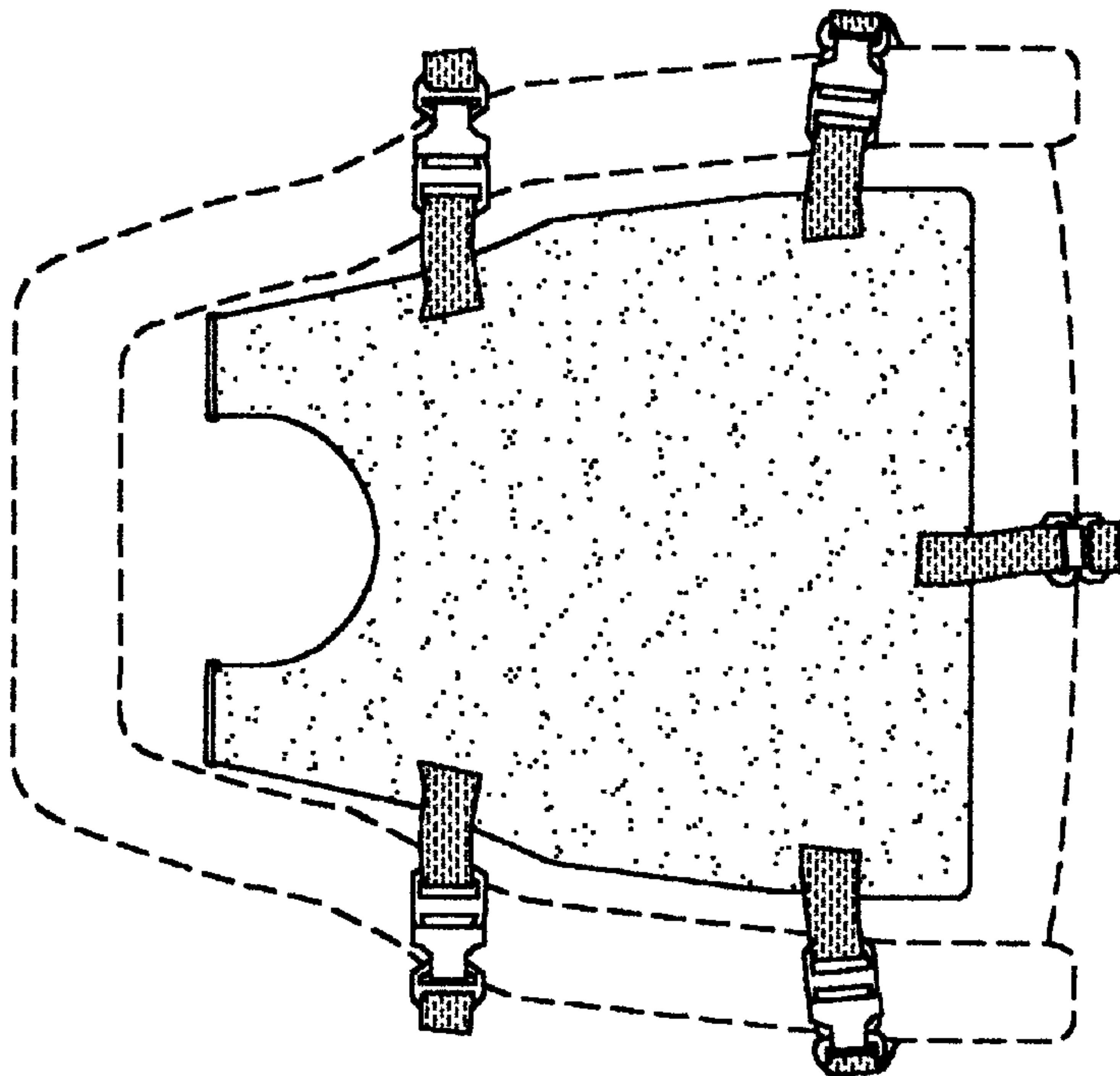

FIG. 5