



US00D441874S

(12) **United States Design Patent**
Jackson et al.

(10) **Patent No.:** **US D441,874 S**

(45) **Date of Patent:** **** May 8, 2001**

(54) **CRAWL SPACE DOOR WITH INTERIOR AND EXTERIOR FLANGE**

4,656,797 * 4/1987 Marquart 52/169.12
6,014,841 * 1/2000 McCoy, Jr. et al. 52/202 X

(76) Inventors: **James S. Jackson**, #4 Oneal Ct.,
Portsmouth, VA (US) 23701; **William G. Sykes**, 3669 Seagull Bluff Dr.,
Virginia Beach, VA (US) 23455

* cited by examiner

Primary Examiner—Louis S. Zarfaz
Assistant Examiner—Robert A. Delehanty

(**) Term: **14 Years**

(57) **CLAIM**

(21) Appl. No.: **29/125,846**

The ornamental design for a crawl space door and frame with interior and exterior flange, as shown and described.

(22) Filed: **Jun. 30, 2000**

DESCRIPTION

(51) **LOC (7) Cl.** **25-02**

(52) **U.S. Cl.** **D25/48**

(58) **Field of Search** D25/47-49, 52,
D25/60-61, 199; 52/169.1, 169.6, 169.12,
302.1, 303.3, 302.7, 202, 211; 454/195;
49/504; 269/905

FIG. 1 is a top plan view of a crawl space door and frame with interior and exterior flange showing our new design; FIG. 2 is a top plan view of a crawl space frame with interior and exterior flange shown separately for clarity of illustration;

FIG. 3 is a top and side perspective view of the door and frame as shown in FIG. 1;

FIG. 4 is a top and side perspective view of the frame as shown in FIG. 2;

FIG. 5 is an enlarged top plan detail view of the frame shown in FIG. 2; and,

FIG. 6 is an enlarged top perspective detail view of the door shown in FIG. 1 shown separately for clarity of illustration.

(56) **References Cited**

U.S. PATENT DOCUMENTS

- D. 213,444 * 3/1969 Helma D25/52
- D. 372,104 * 7/1996 Scott D25/48
- D. 374,486 * 10/1996 Guin D25/48
- D. 407,500 * 3/1999 Gribble D25/48
- 3,796,008 * 3/1974 Eakin 49/504 X

1 Claim, 6 Drawing Sheets

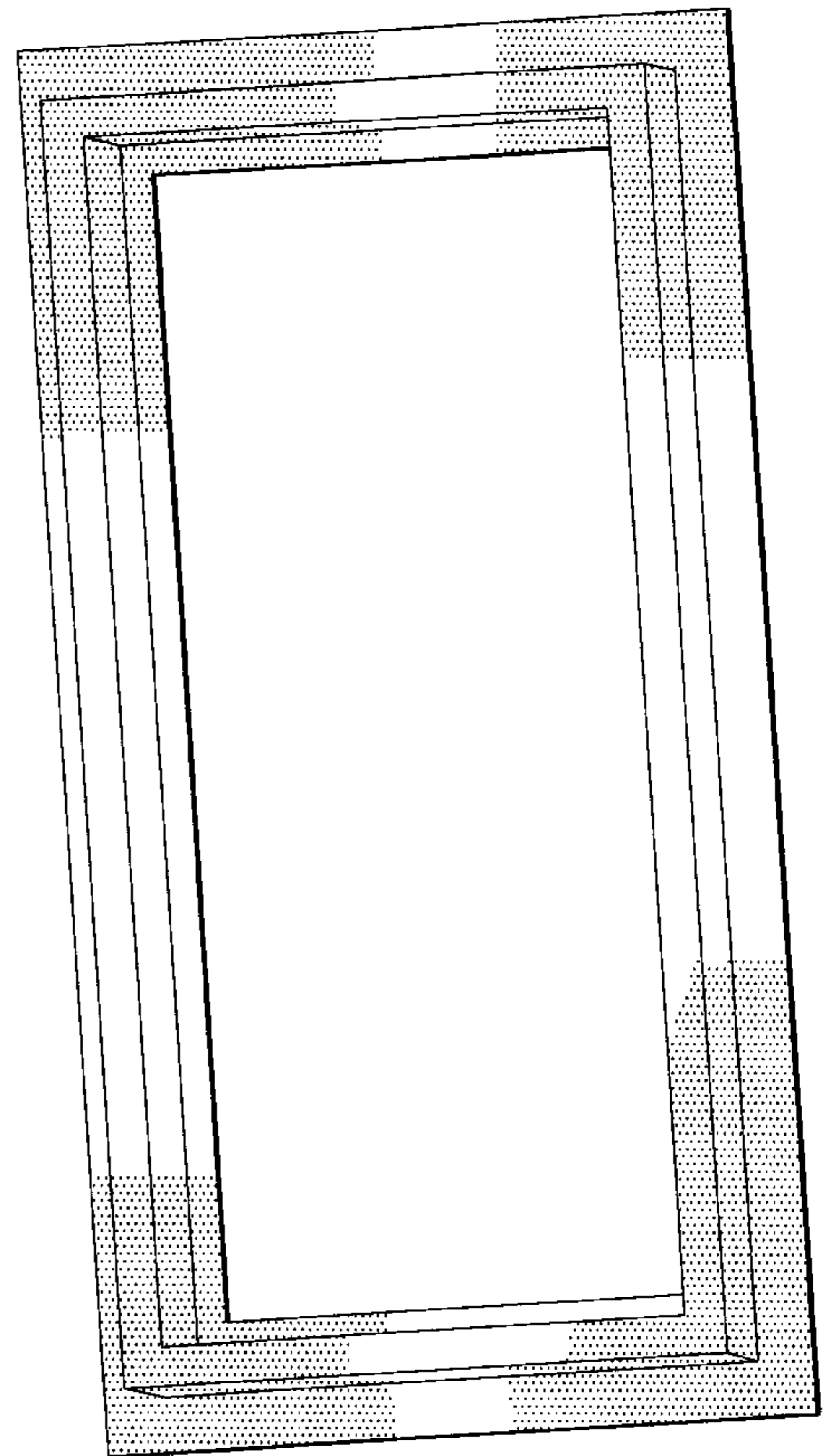
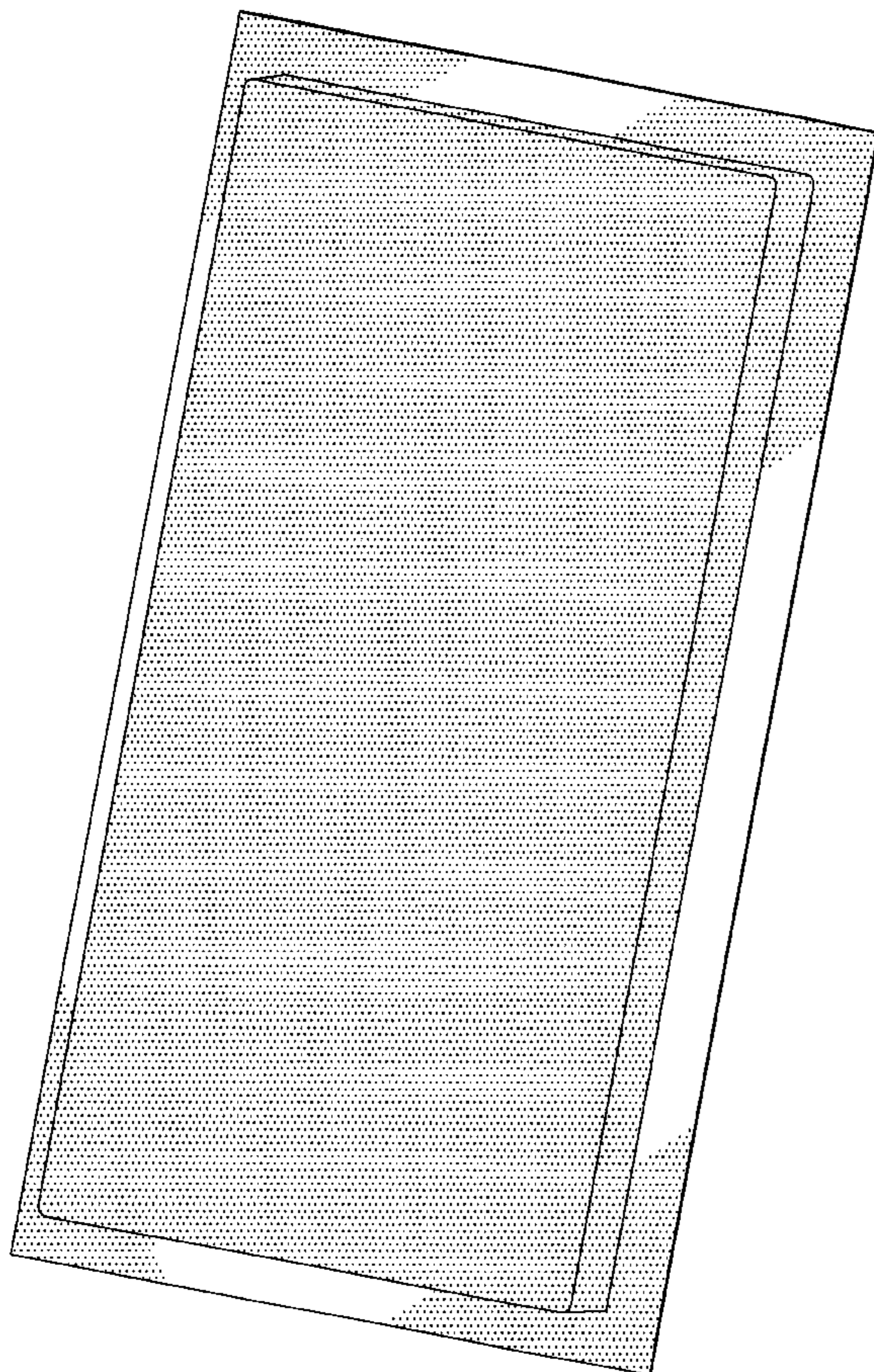

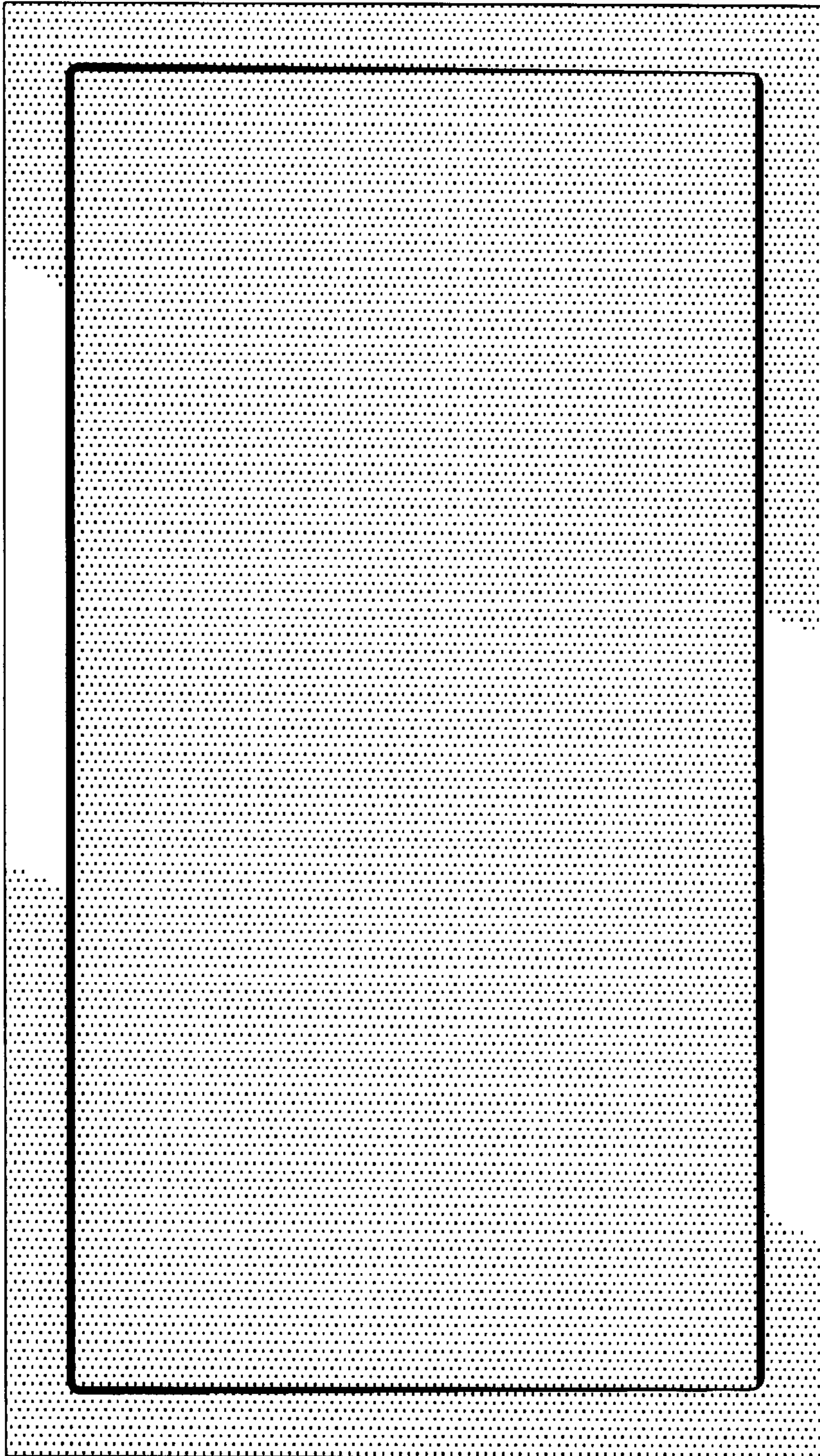

FIGURE 1

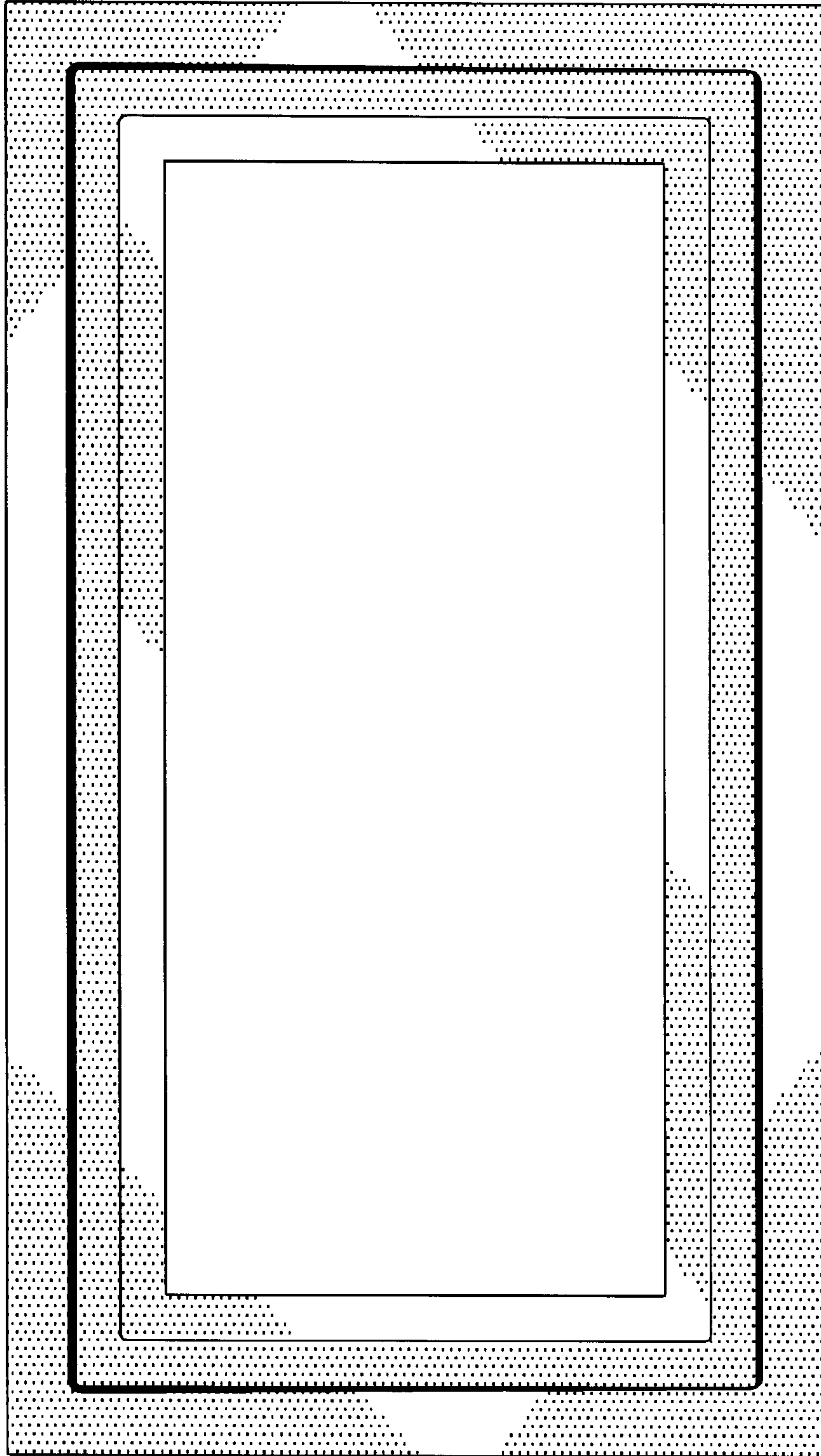

FIGURE 2

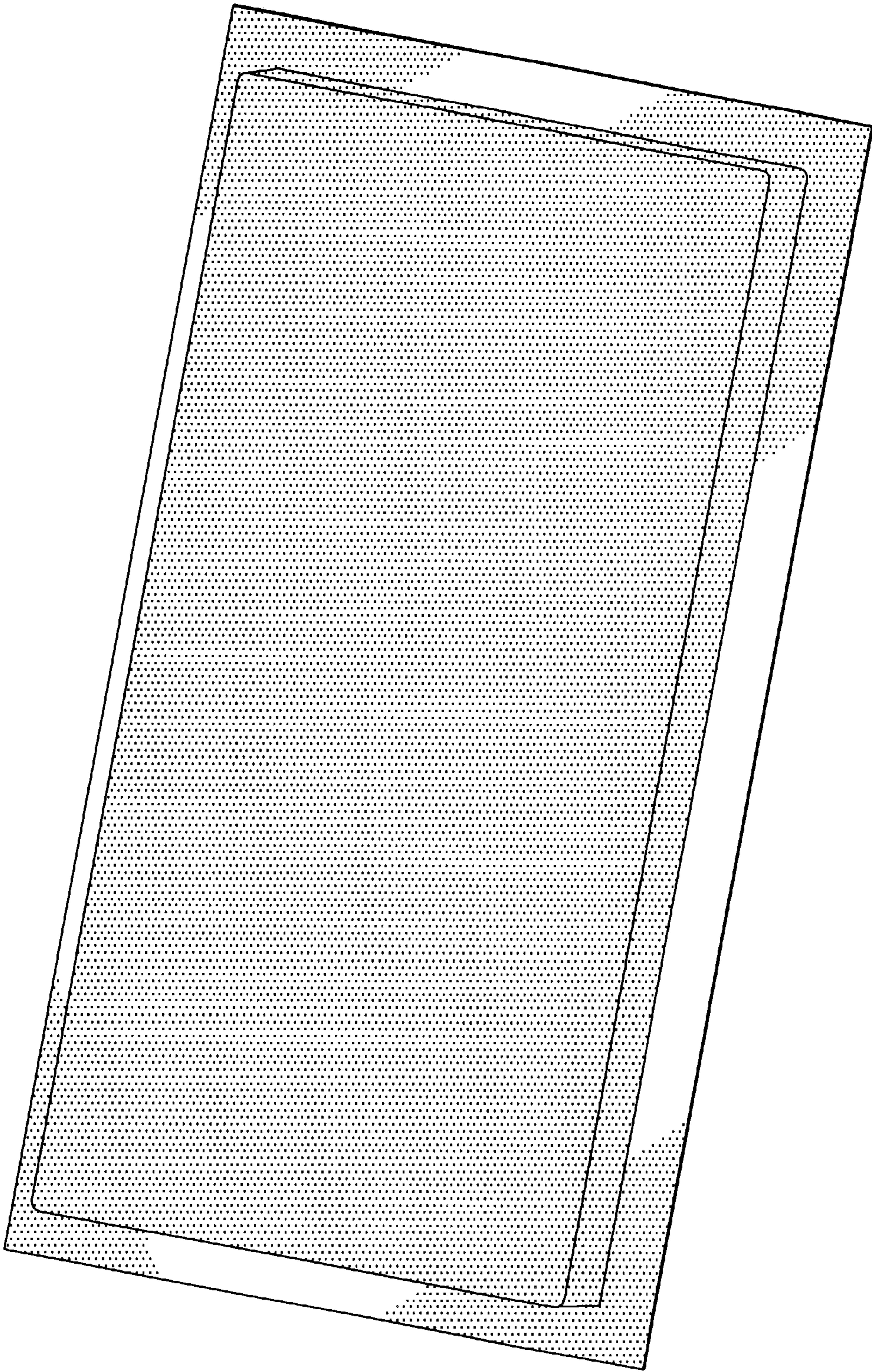

FIGURE 3

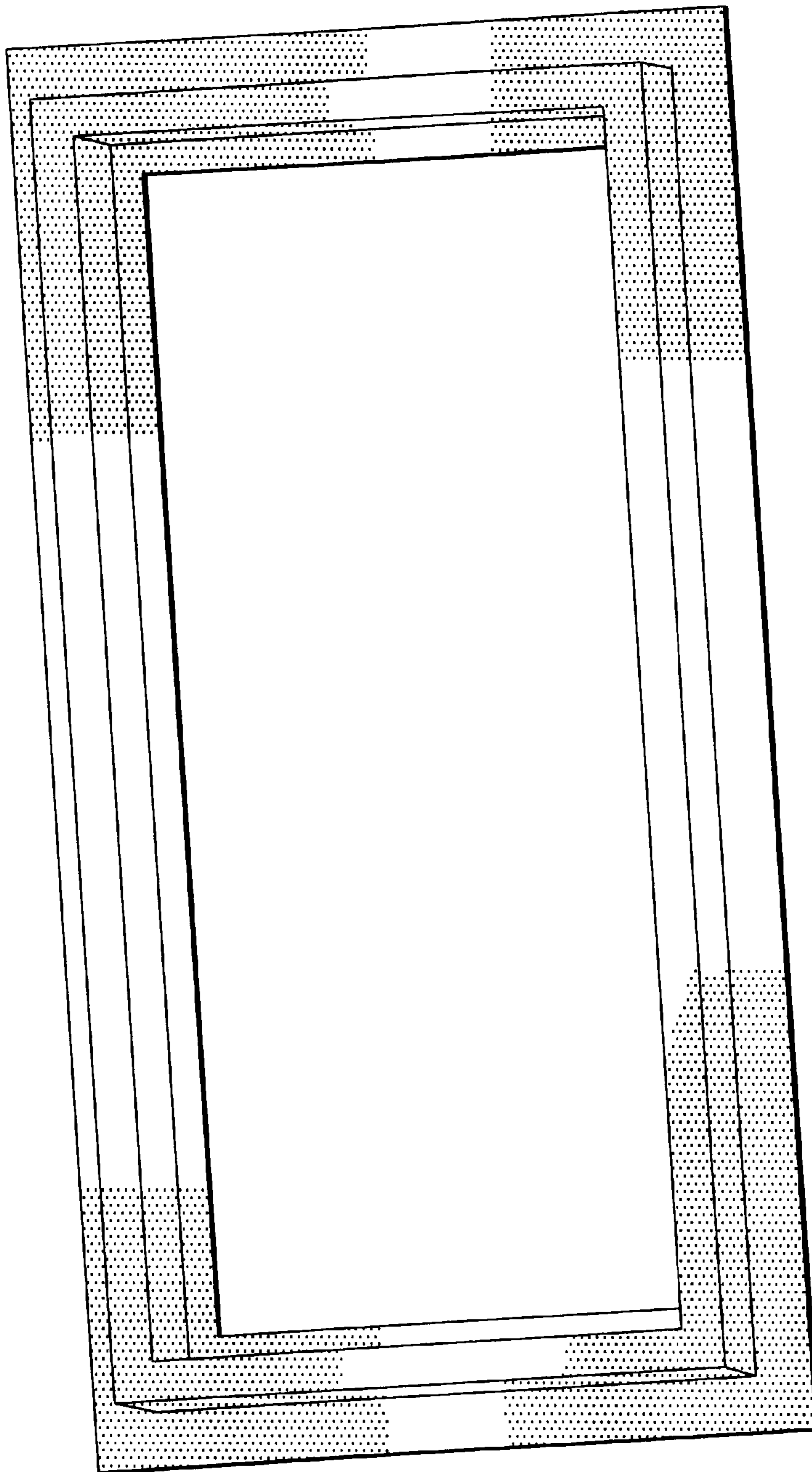

FIGURE 4

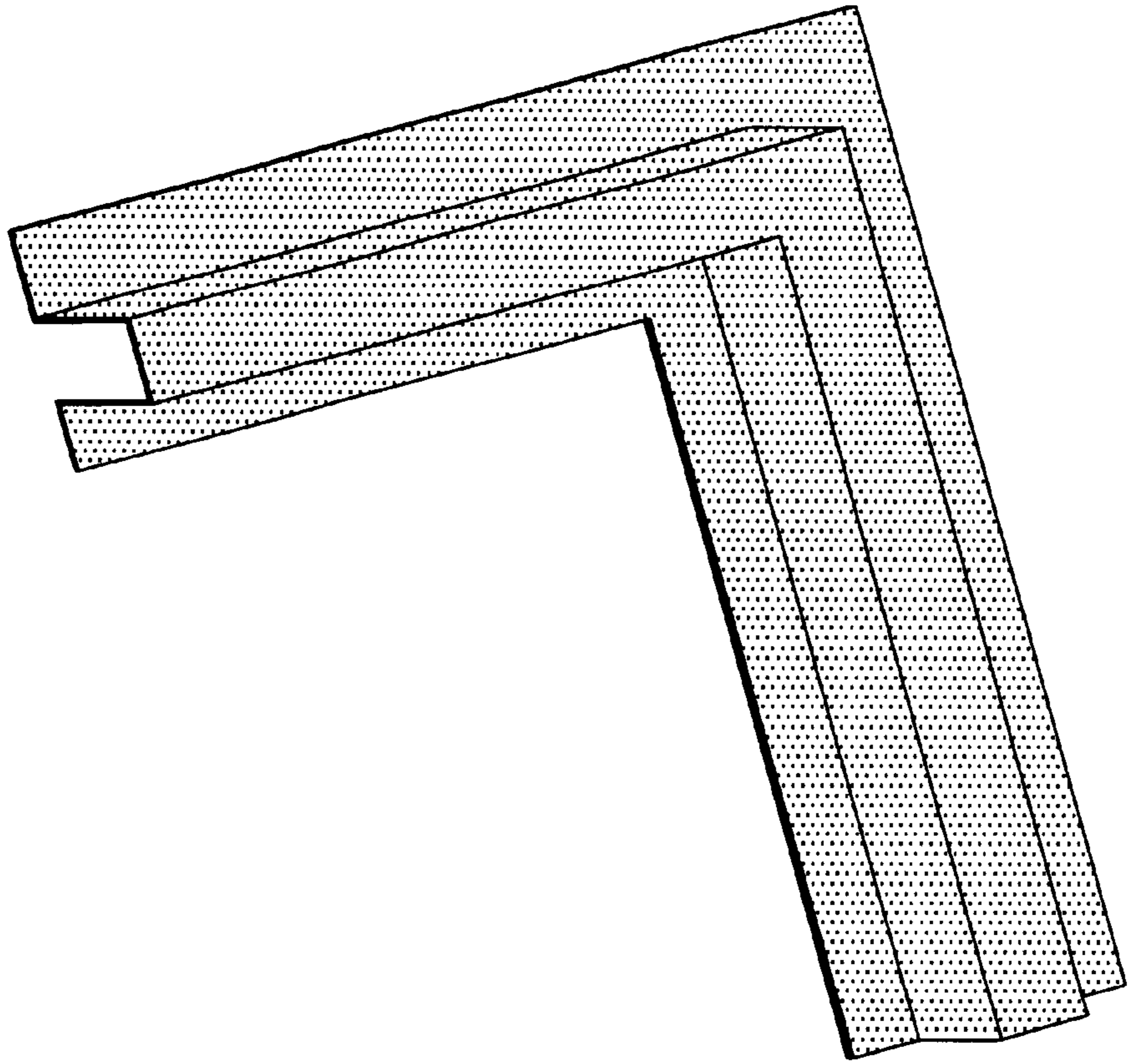

FIGURE 5

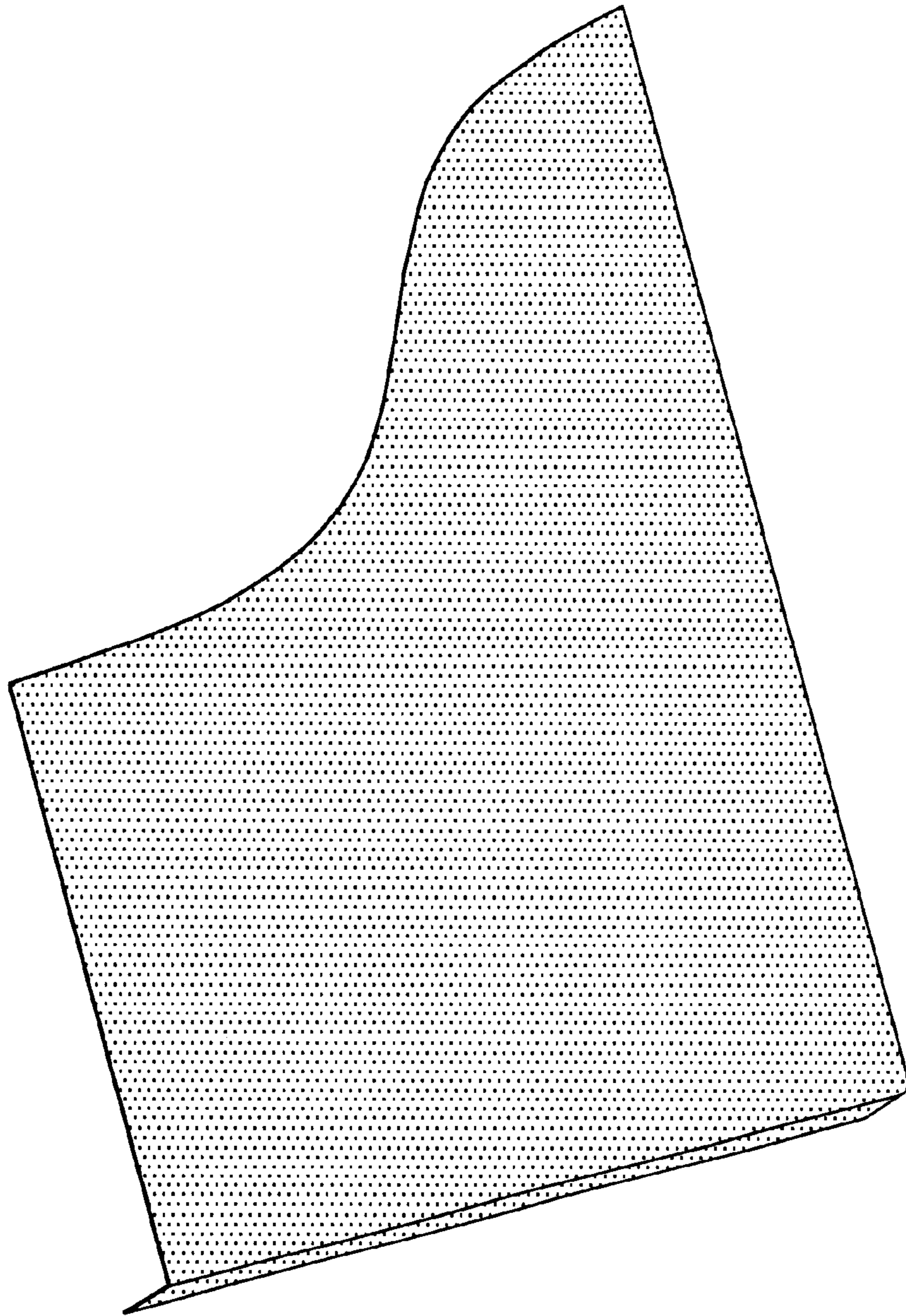

FIGURE 6