



US00D441799S

(12) **United States Design Patent**  
**Ho**

(10) **Patent No.:** **US D441,799 S**

(45) **Date of Patent:** **\*\* May 8, 2001**

(54) **LABEL-ADHERING DEVICE FOR OPTICAL DISKS**

D. 433,456 \* 11/2000 Hooglander ..... D20/22

\* cited by examiner

(75) **Inventor:** **Chi-Pei Ho, Taipei Hsien (TW)**

*Primary Examiner*—Marcus A. Jackson

(73) **Assignee:** **Aidma Enterprise Co., Ltd., Taipei Hsien (TW)**

(74) *Attorney, Agent, or Firm*—Pro-Techtor International Services

(\*\*) **Term:** **14 Years**

(57) **CLAIM**

The ornamental design for label-adhering device for optical disks, as shown and described.

(21) **Appl. No.:** **29/126,260**

**DESCRIPTION**

(22) **Filed:** **Jul. 11, 2000**

(51) **LOC (7) Cl.** ..... **19-08**

FIG. 1 is a perspective view of label-adhering device for optical disks showing my new design;

(52) **U.S. Cl.** ..... **D20/22; D20/99**

FIG. 2 is a front elevational view thereof;

(58) **Field of Search** ..... D20/10, 11, 22-28, D20/99; 40/1, 1.5, 1.6, 5, 6, 299, 633

FIG. 3 is a rear elevational view thereof;

FIG. 4 is a top plan view thereof;

FIG. 5 is a bottom plan view thereof;

(56) **References Cited**

FIG. 6 is a left side elevational view thereof; and,

FIG. 7 is a right side elevational view thereof.

**U.S. PATENT DOCUMENTS**

D. 94,218 \* 1/1935 Henkel ..... D20/99

**1 Claim, 4 Drawing Sheets**

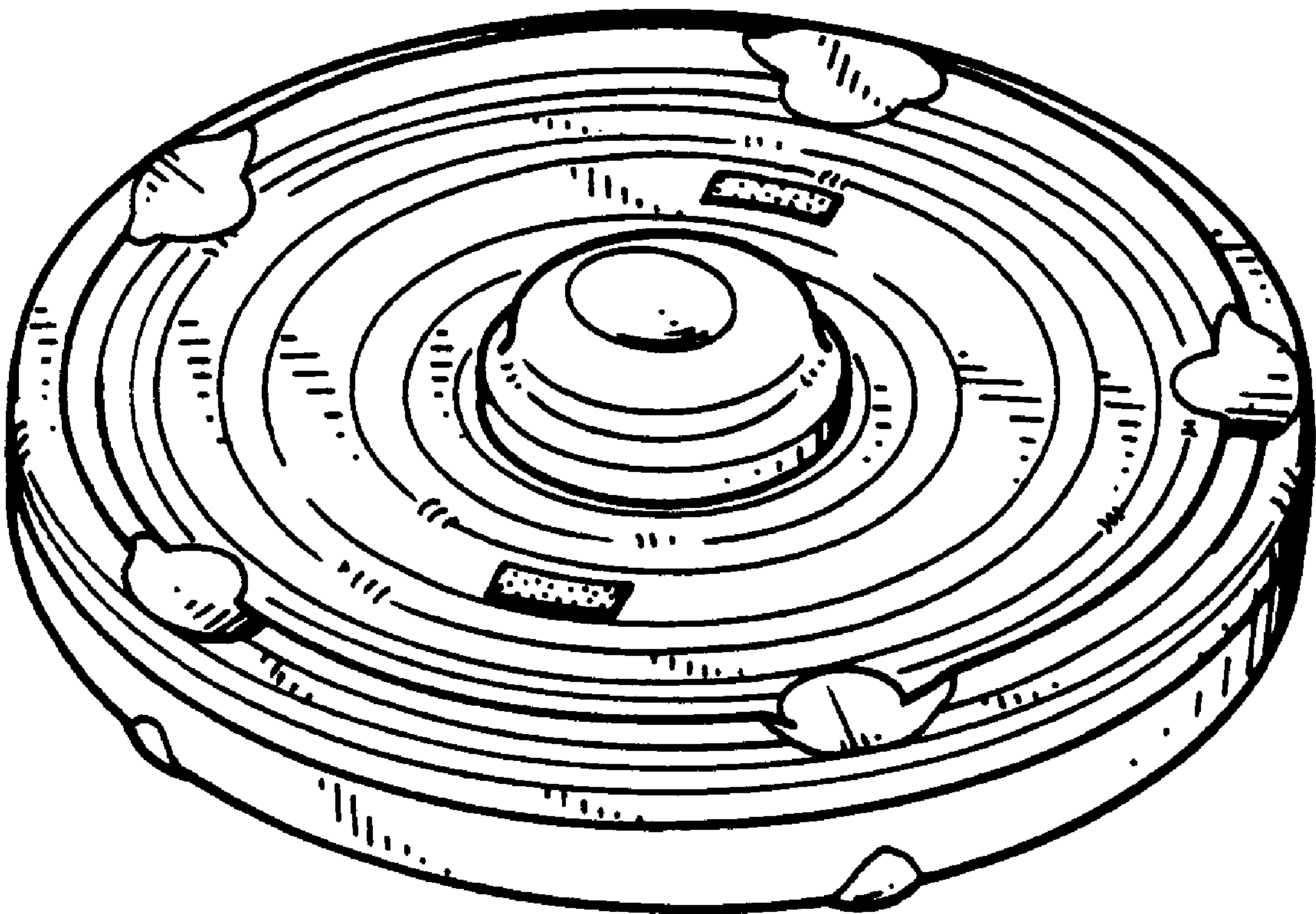

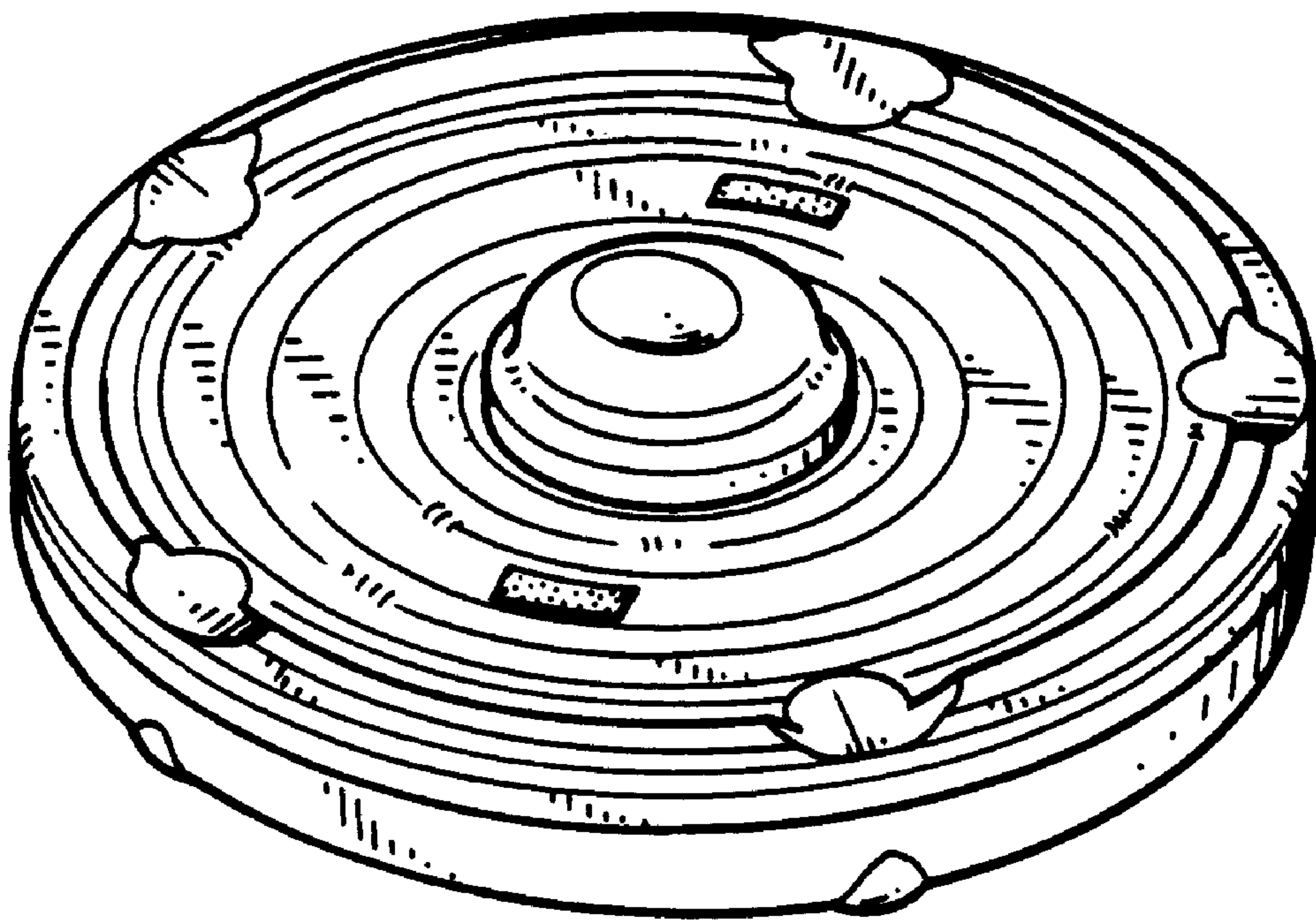

FIG. 1

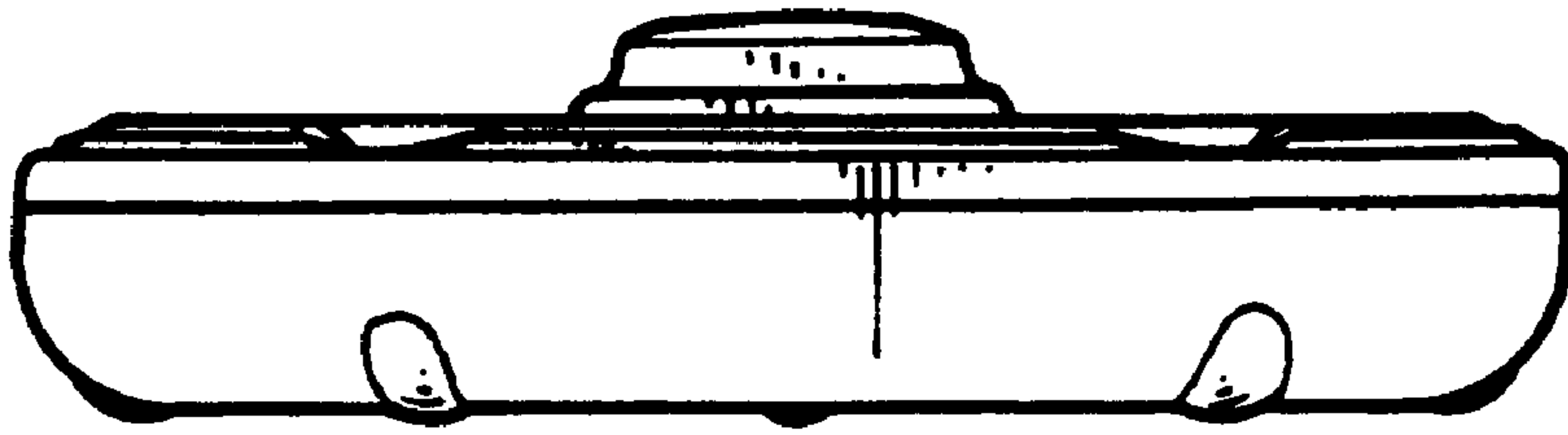

FIG. 2

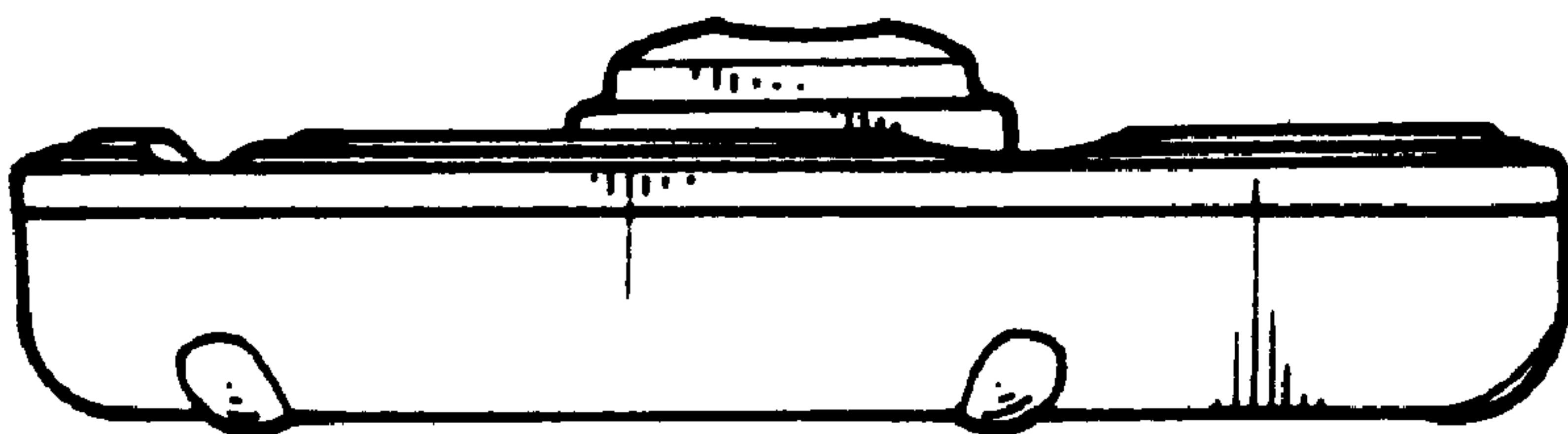

FIG. 7

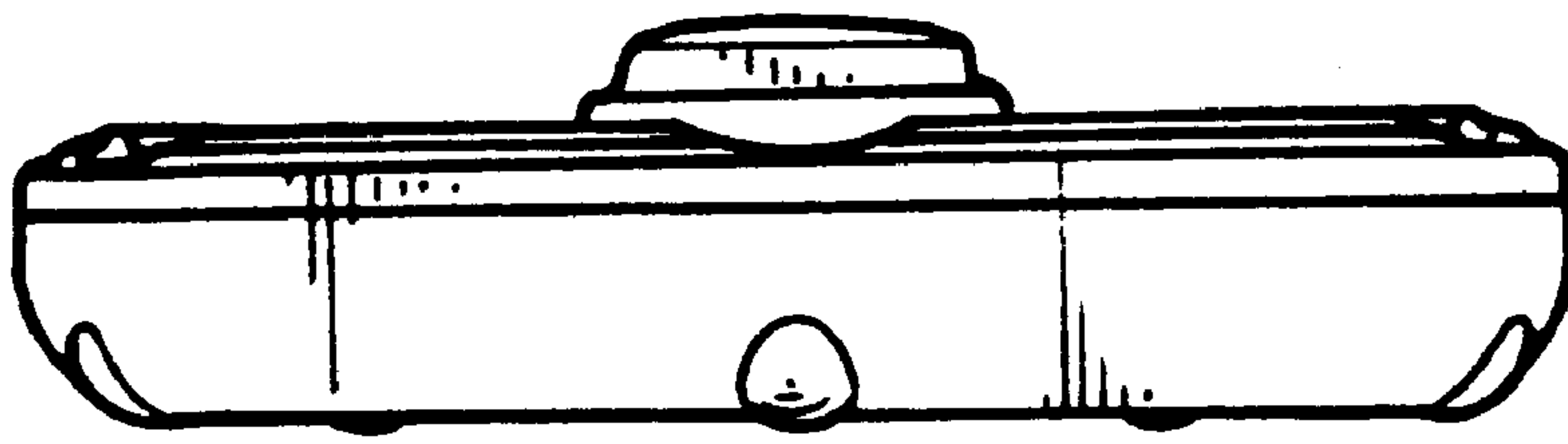

FIG. 3

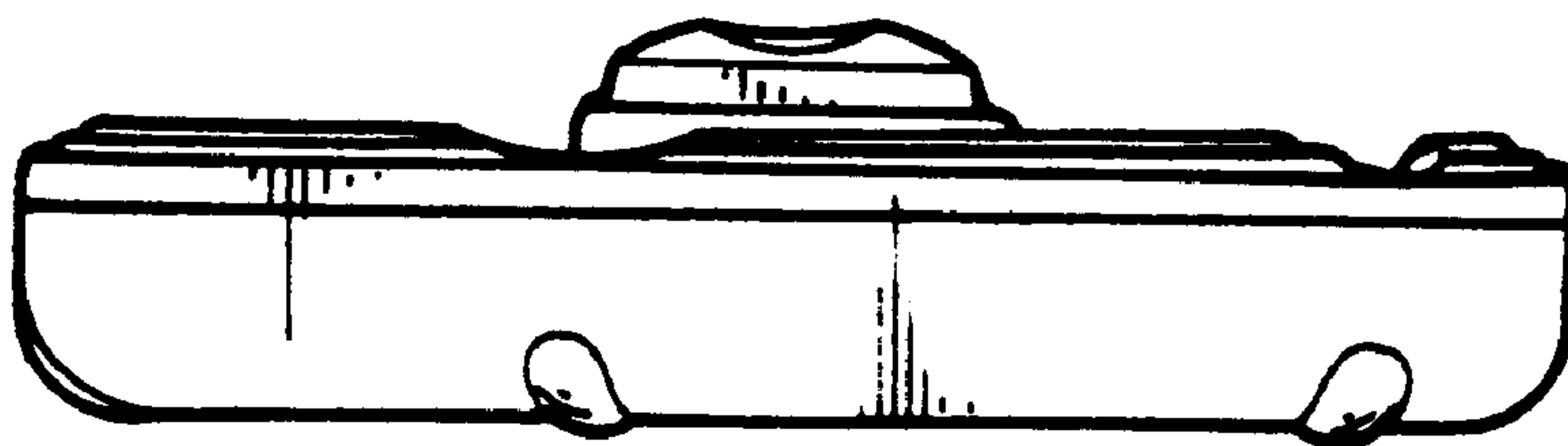

FIG. 6

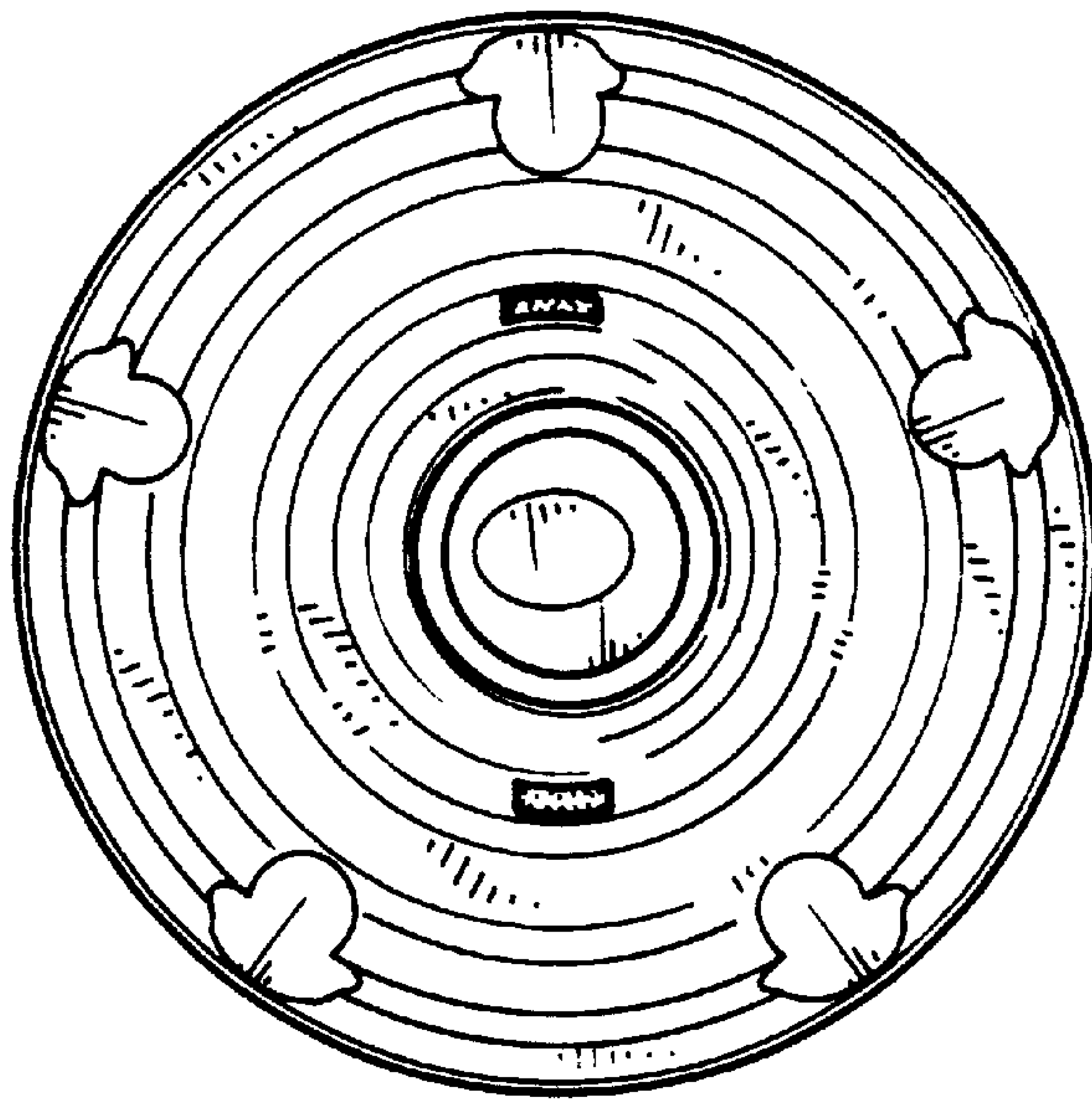

FIG. 4

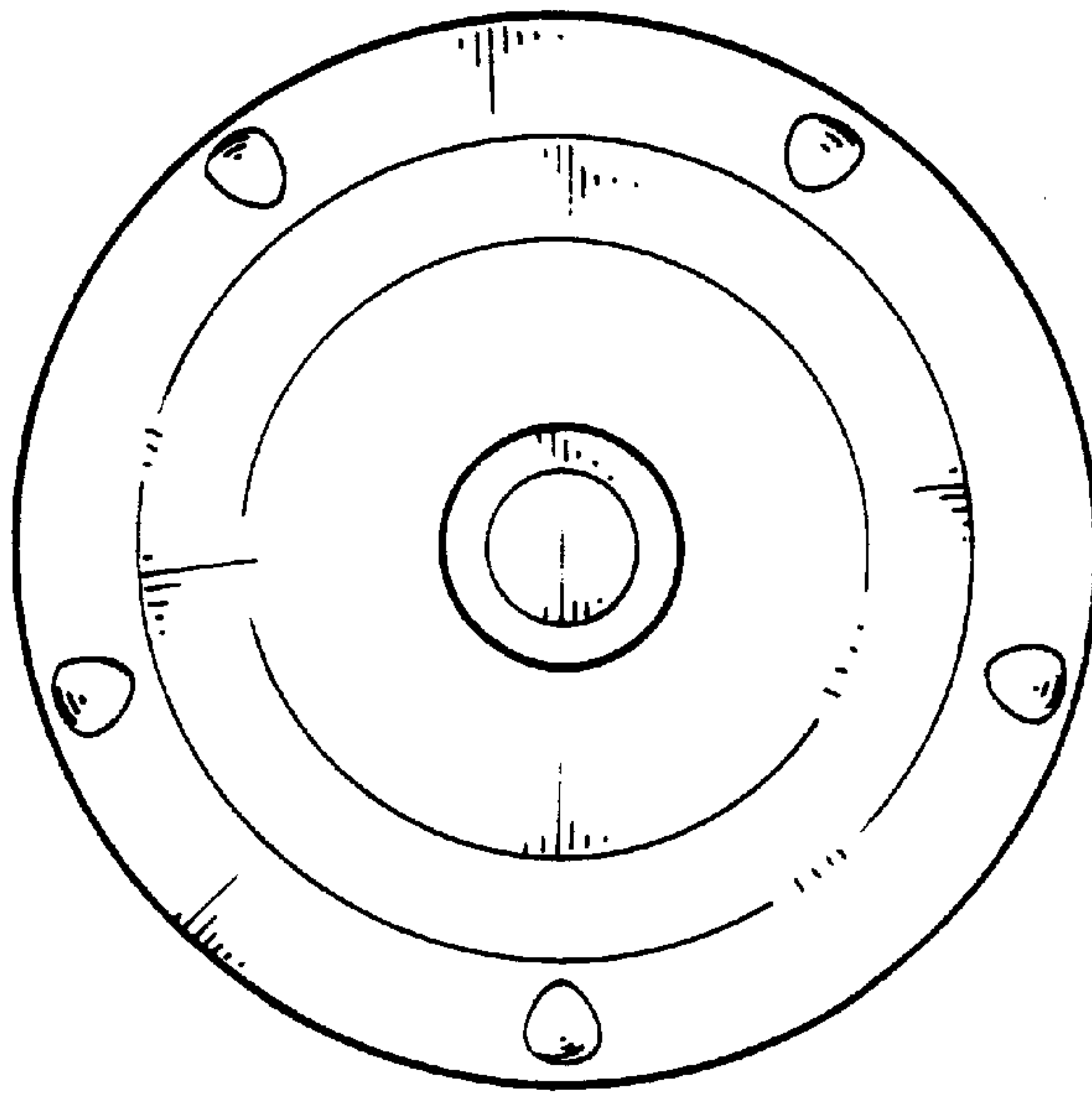

FIG. 5