



US00D441795S

(12) **United States Design Patent**
De Regt et al.

(10) **Patent No.:** **US D441,795 S**

(45) **Date of Patent:** **** May 8, 2001**

(54) **ADHESIVE TAPE DISPENSER**

(75) Inventors: **Jeroen Daniel De Regt, Oss; Eelco Han De Man, Helmond, both of (NL)**

(73) Assignee: **Ray Technology Group B.V. (NL)**

(**) Term: **14 Years**

(21) Appl. No.: **29/124,717**

(22) Filed: **Jun. 9, 2000**

(30) **Foreign Application Priority Data**

Dec. 9, 1999 (XH) DM/050 340

(51) **LOC (7) Cl.** **19-02**

(52) **U.S. Cl.** **D19/69; D19/67**

(58) **Field of Search** D19/65, 67, 68,
D19/69, 72, 89, 95, 99, 100; 156/523, 527,
327, 577; 225/6, 7, 12, 19, 22, 25, 34,
35, 45, 56, 74, 77, 89, 11; 242/588, 588.1-588.6,
590, 564.4

(56) **References Cited**

U.S. PATENT DOCUMENTS

- D. 128,158 * 7/1941 Booty D19/67 X
- D. 175,066 * 7/1955 Emmert D19/67
- D. 177,214 * 3/1956 Castelli et al. D19/67

- D. 214,405 * 6/1969 Fleming D19/69
- D. 228,815 * 10/1973 Campbell, Jr. D19/69
- D. 413,630 * 9/1999 Mandar D19/69
- D. 429,764 * 8/2000 De Man et al. D19/69
- 2,308,840 * 1/1943 Vaughan et al. 242/564.4

* cited by examiner

Primary Examiner—Martie K. Holtje

(74) *Attorney, Agent, or Firm*—Oldham & Oldham Co. LPA

(57) **CLAIM**

The ornamental design for the adhesive tape dispenser, as shown and described.

DESCRIPTION

FIG. 1 is a front perspective view of an adhesive tape dispenser with our new design;
 FIG. 2 is a rear perspective view of FIG. 1;
 FIG. 3 is a further front perspective view of FIG. 1, showing the dispenser's detachable base;
 FIG. 4 is a rear elevational view of FIG. 1;
 FIG. 5 is a top plan view of FIG. 1;
 FIG. 6 is a right side elevational view of FIG. 1, the opposite side being a mirror image of that shown;
 FIG. 7 is a bottom plan view of FIG. 1; and,
 FIG. 8 is a front elevational view of FIG. 1.

1 Claim, 3 Drawing Sheets

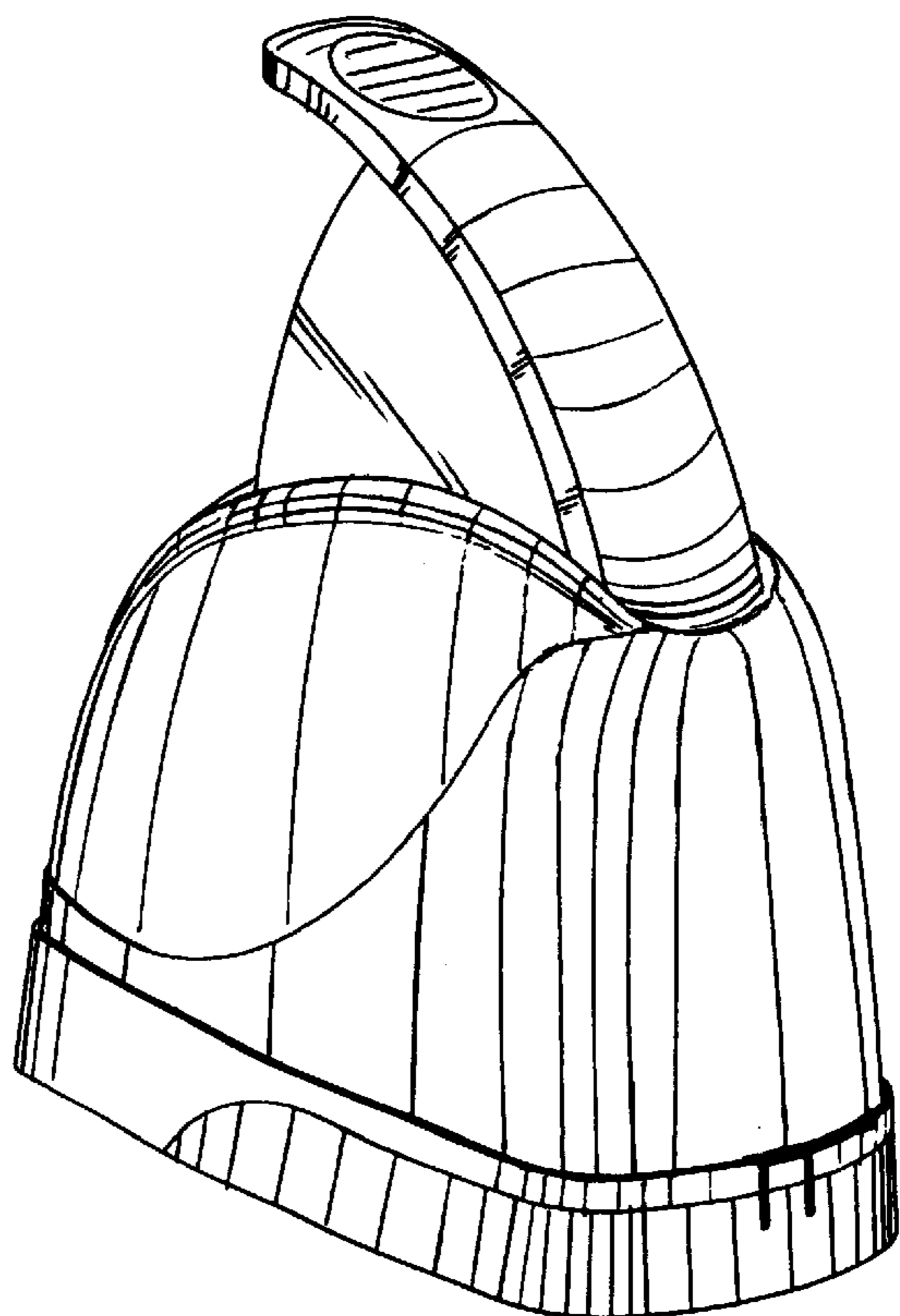
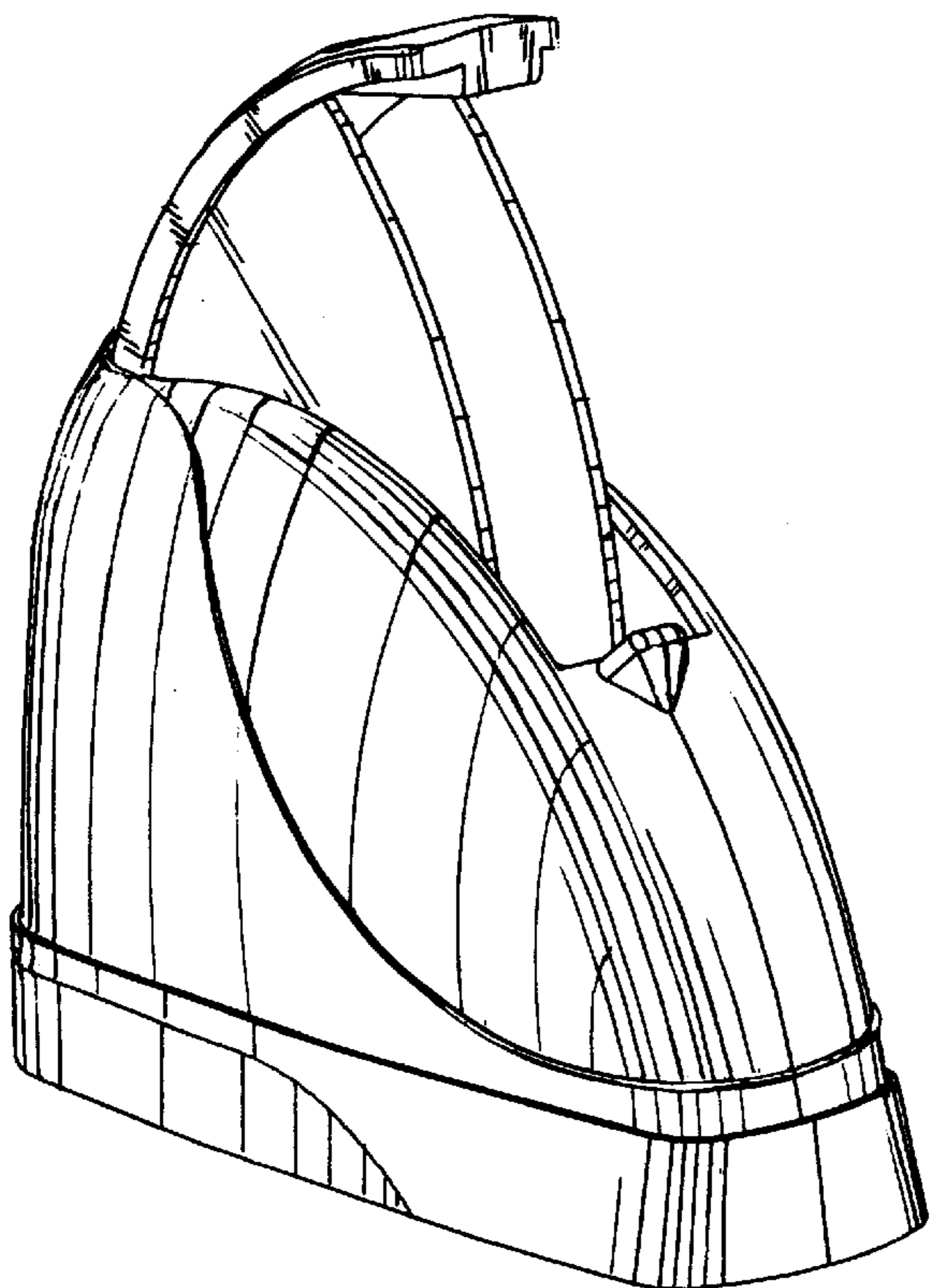

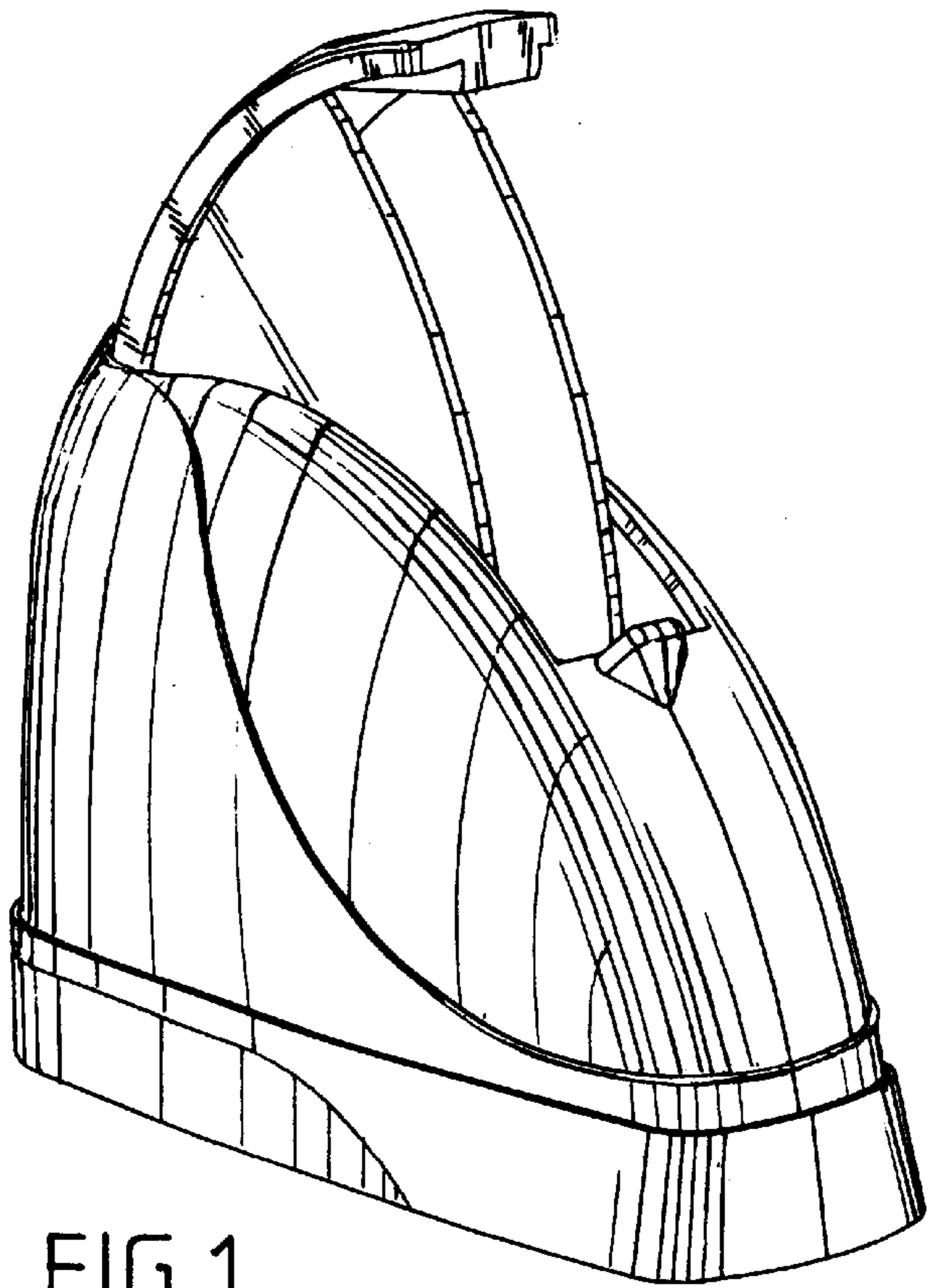

FIG. 1

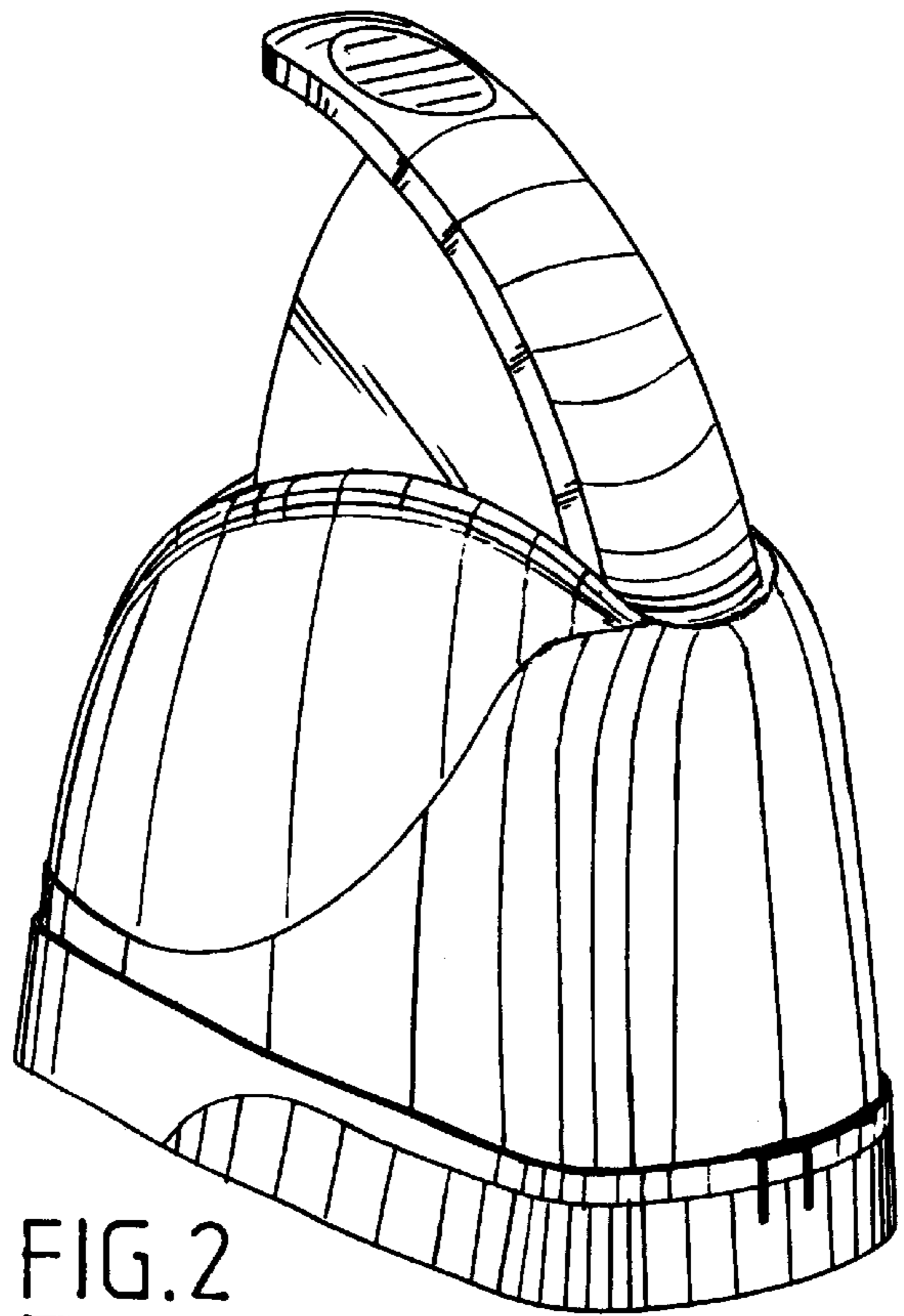

FIG. 2

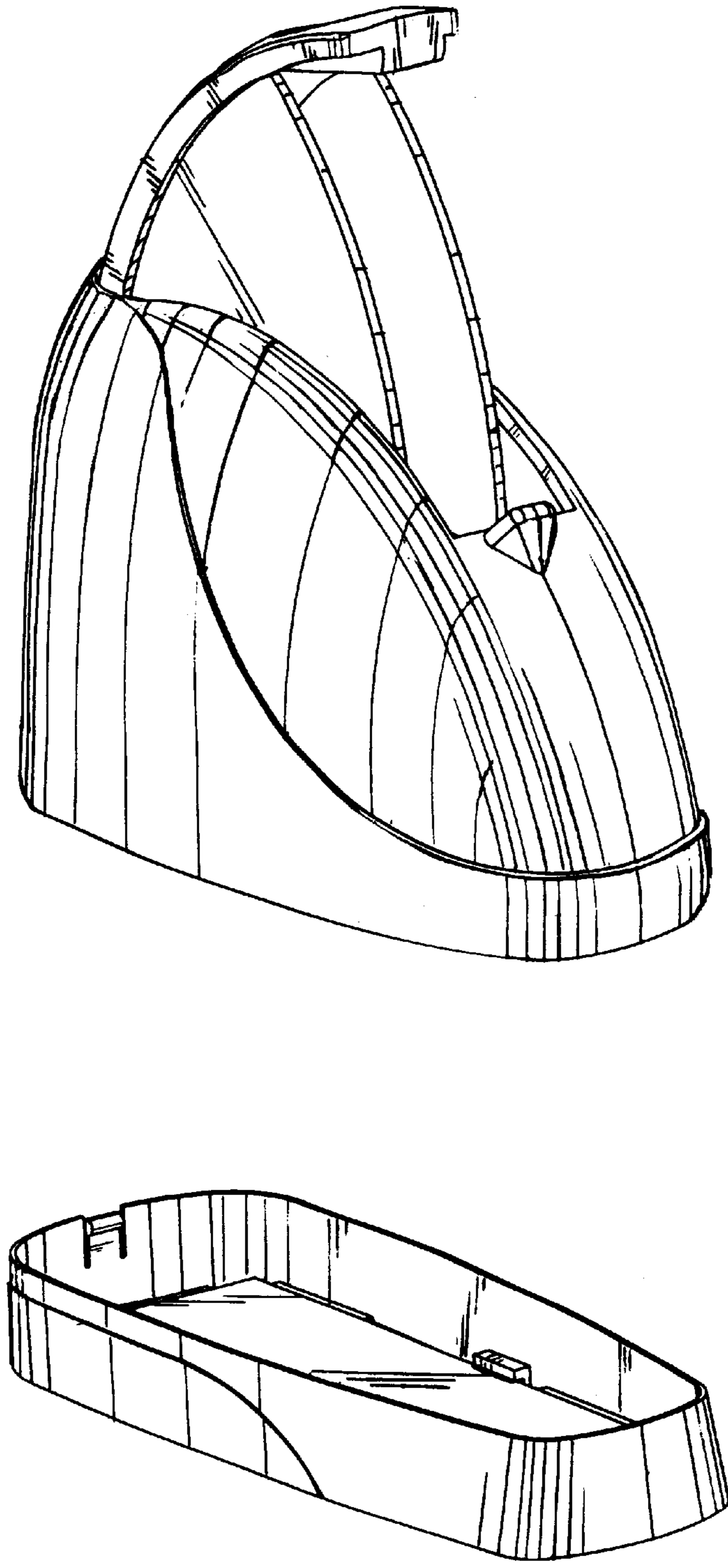

FIG. 3

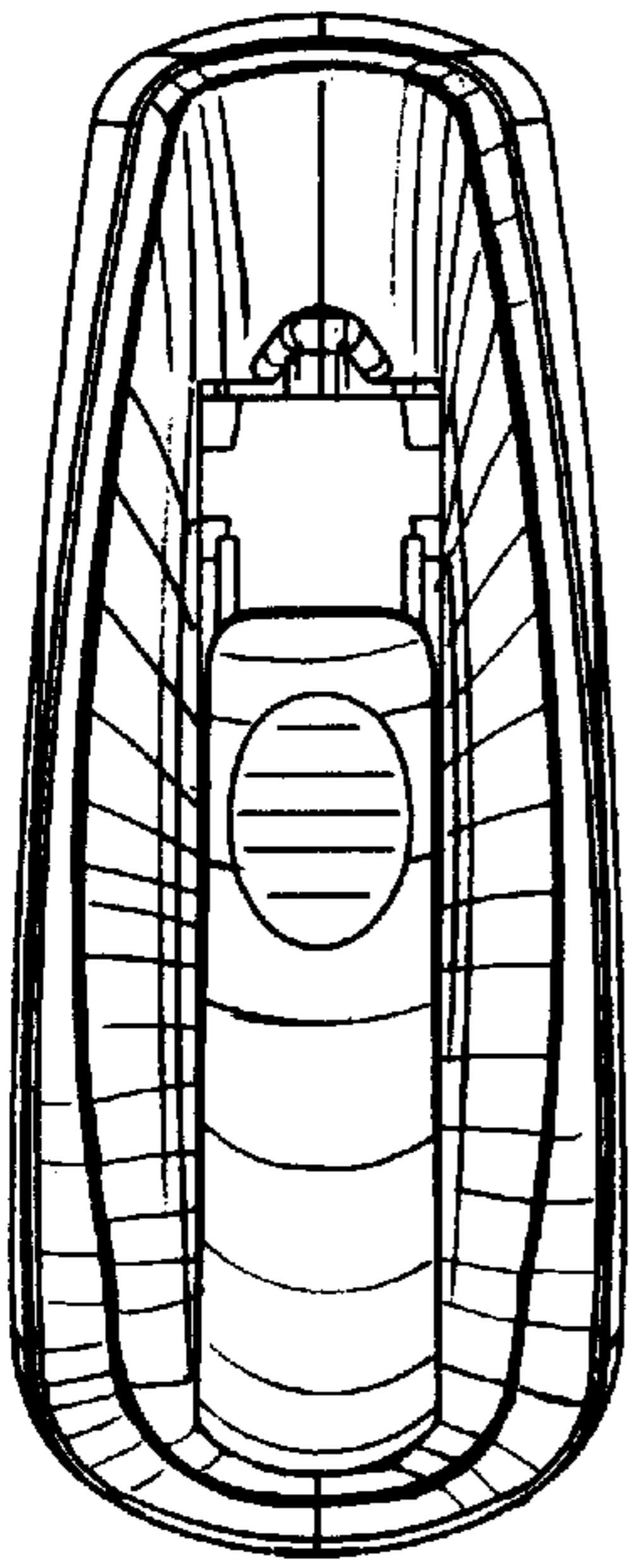

FIG. 5

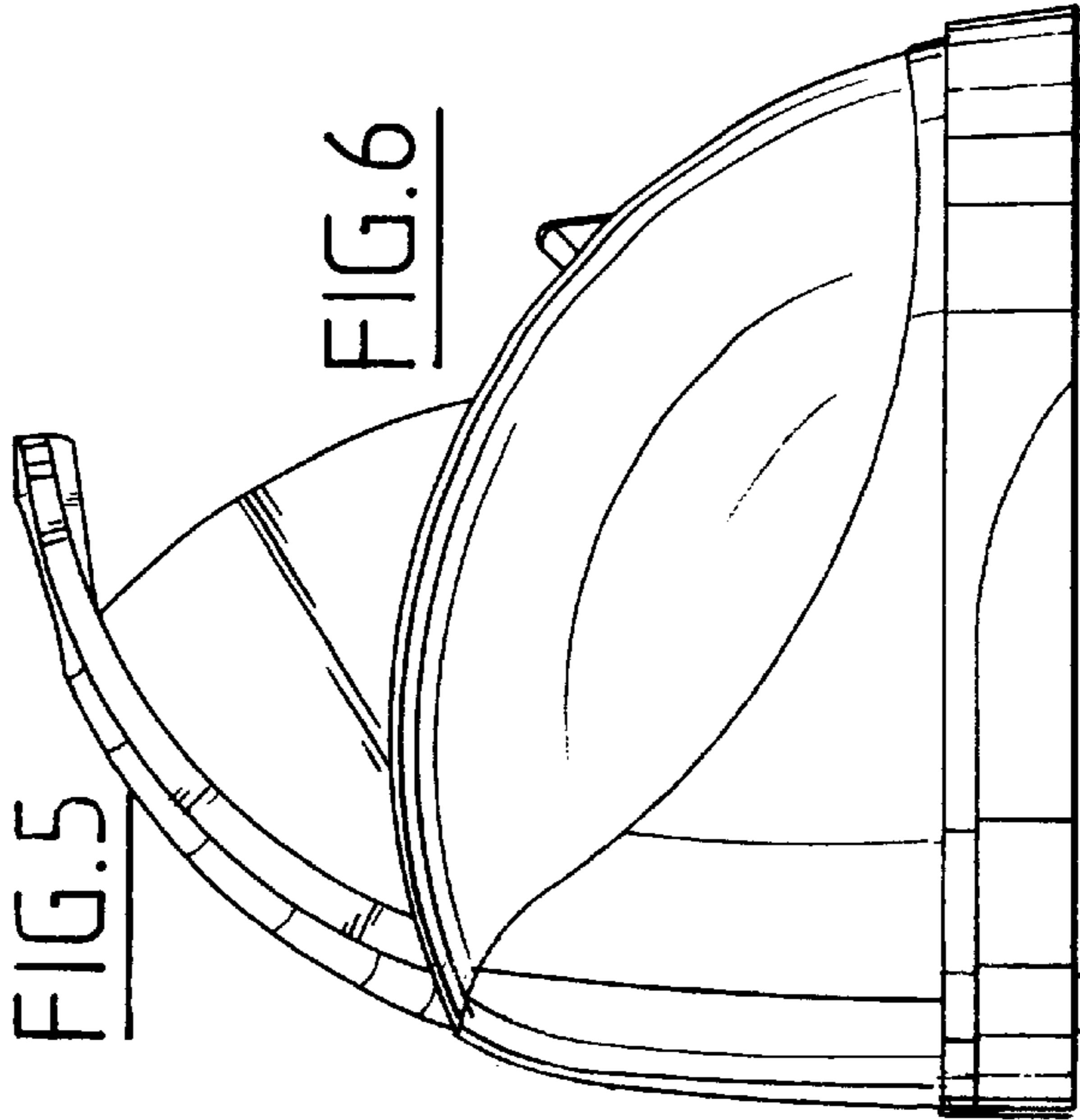

FIG. 6

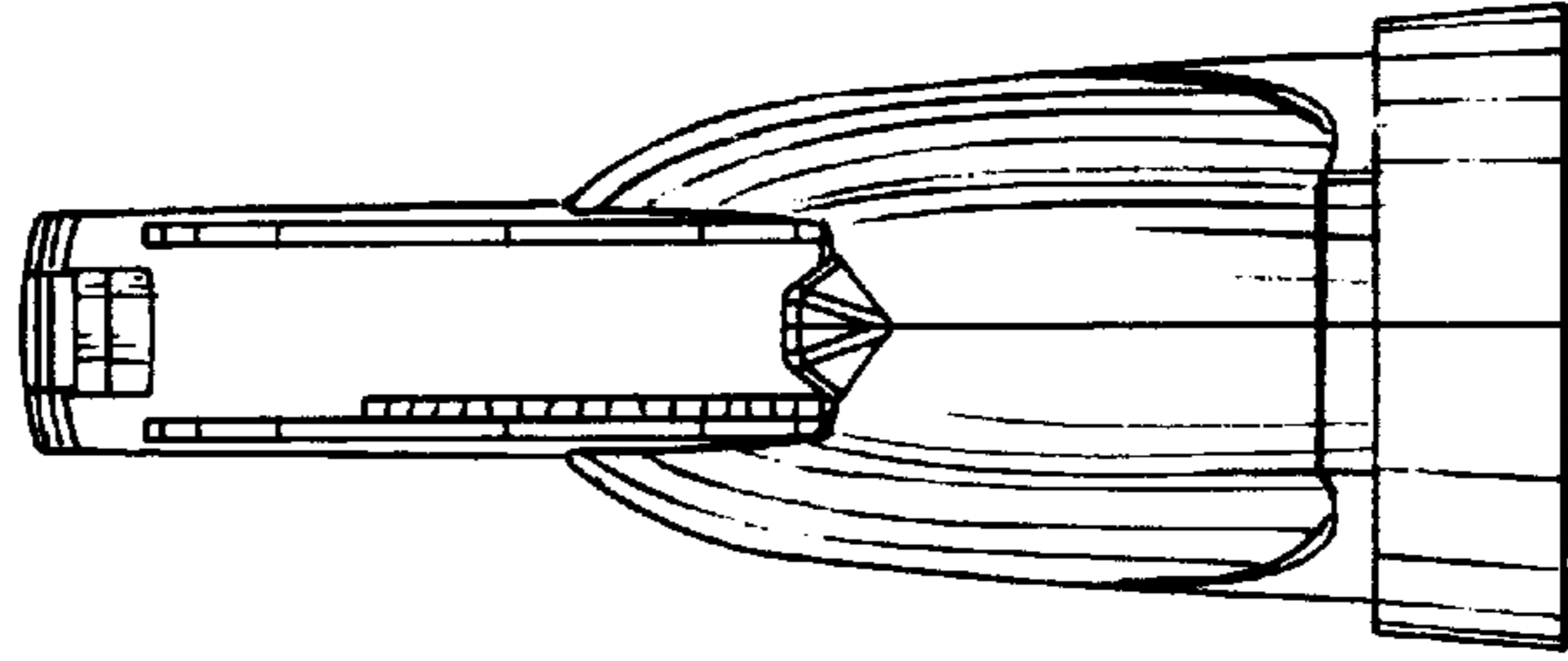

FIG. 8

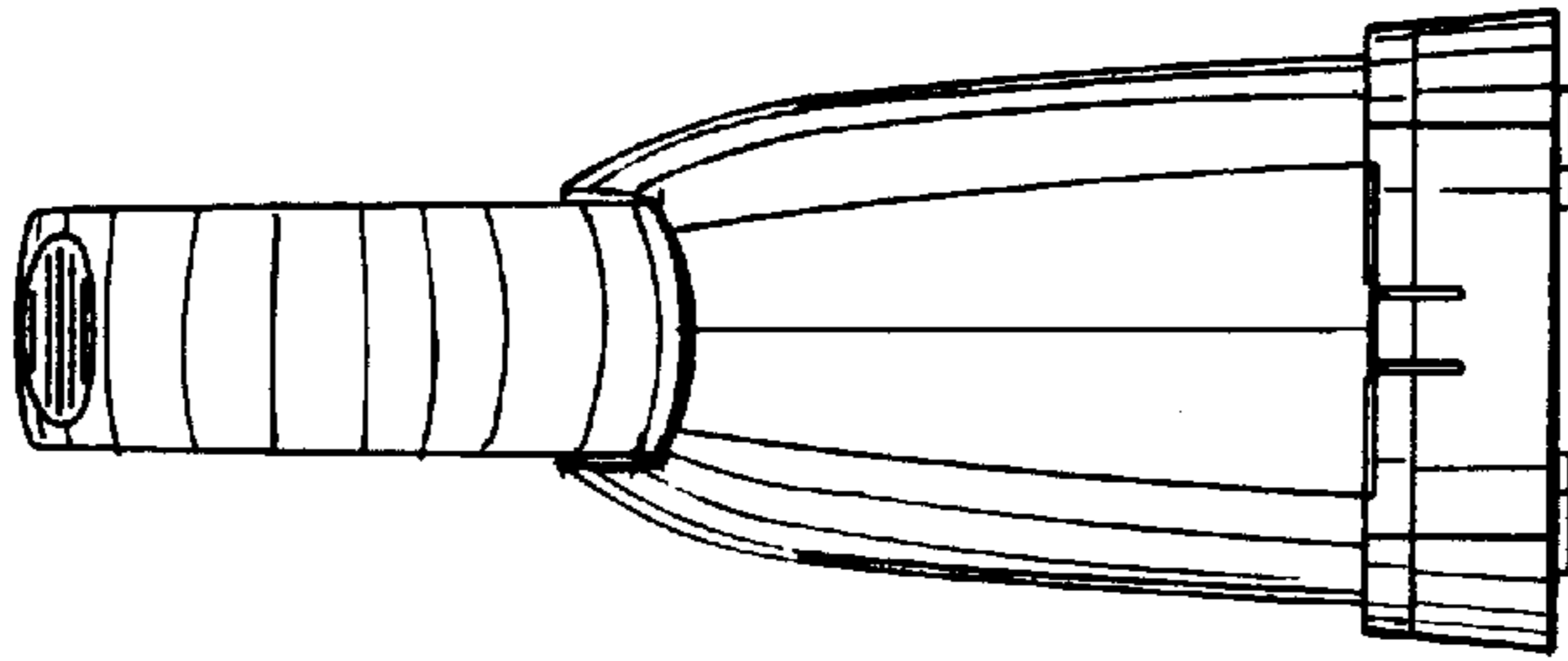

FIG. 4

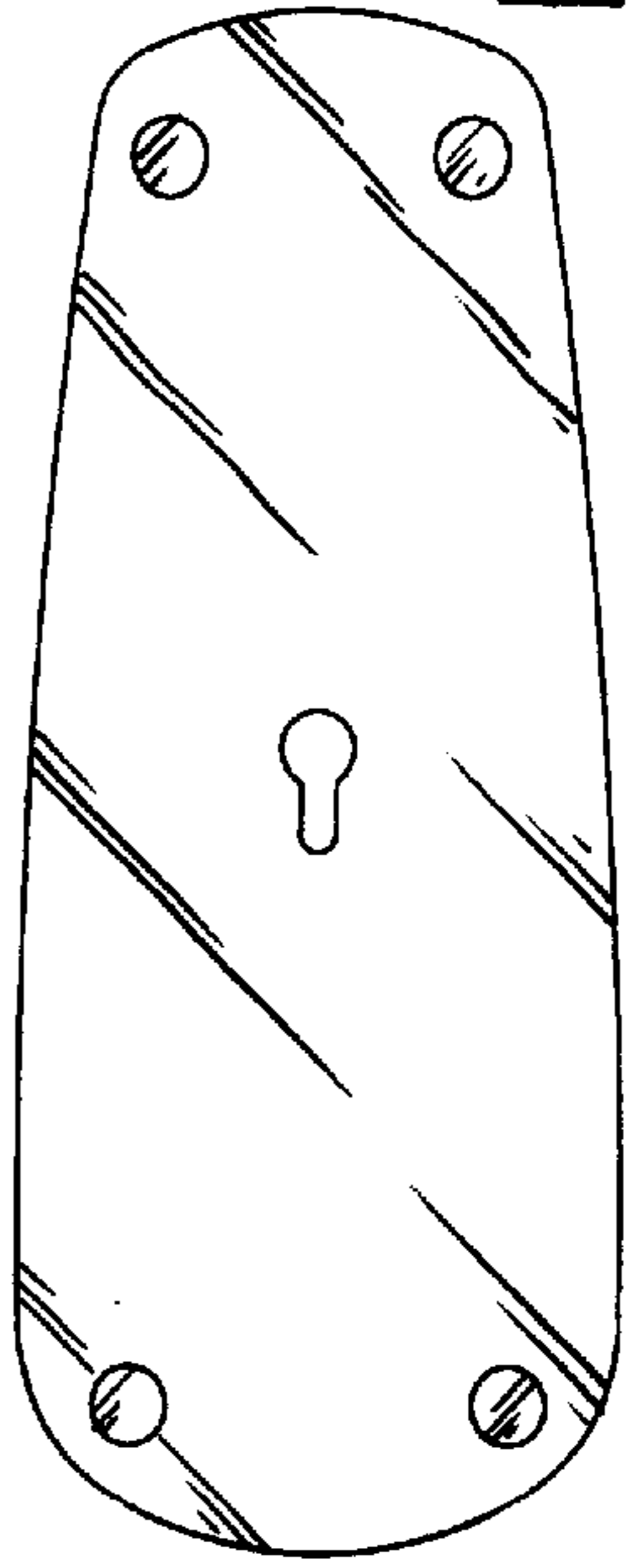

FIG. 7