



US00D441654S

(12) **United States Design Patent**
Sayers

(10) **Patent No.:** **US D441,654 S**

(45) **Date of Patent:** **** May 8, 2001**

(54) **LIQUID DISPENSER**

(75) Inventor: **Richard C. Sayers**, Perrysburg, OH (US)

(73) Assignee: **Owens-Illinois Closure Inc.**, Toledo, OH (US)

(**) Term: **14 Years**

(21) Appl. No.: **29/069,936**

(22) Filed: **Apr. 18, 1997**

(51) **LOC (7) Cl.** **09-07**

(52) **U.S. Cl.** **D9/448**

(58) **Field of Search** D9/300, 301, 440, D9/447, 448; 22/320, 321.1, 321.7, 321.9, 323, 324, 383.1, 385, 402.1, 402.21, 402.24, 153.13, 153.07

(56) **References Cited**

U.S. PATENT DOCUMENTS

D. 208,825	10/1967	Hutton .	
D. 218,553	9/1970	Nigro .	
D. 219,124	11/1970	Gortz et al. .	
D. 224,508	8/1972	Newby .	
D. 253,398	11/1979	Niemeyer et al. .	
D. 272,988	3/1984	Podall et al. .	
D. 275,933	10/1984	Topor et al. .	
D. 279,511	7/1985	Matsubara .	
D. 291,972	9/1987	Pfeiffer .	
D. 314,149	1/1991	Guilbert .	
D. 314,688	2/1991	Guillerm .	
D. 347,385	5/1994	Kunesh .	
D. 349,045	7/1994	Schmitt .	
D. 356,494 *	3/1995	Eke et al.	D9/300
D. 356,947 *	4/1995	Mueller	D9/300
D. 377,755 *	2/1997	Kotyuk, Jr. et al.	D9/300

(List continued on next page.)

FOREIGN PATENT DOCUMENTS

1399208	6/1964	(FR) .
1444567	8/1965	(FR) .
1542927	10/1967	(FR) .

OTHER PUBLICATIONS

“Emballages” (1981)—p. 97.

Primary Examiner—Cathron Brooks

(57) **CLAIM**

The ornamental design for a liquid dispenser, as shown and described.

DESCRIPTION

FIG. 1 is a perspective view of the liquid dispenser showing my new design;
 FIG. 2 is a side elevational view;
 FIG. 3 is a top plan view;
 FIG. 4 is a front elevational;
 FIG. 5 is a rear elevational view;
 FIG. 6 is a bottom plan view;
 FIG. 7 is a fragmentary view on an enlarged scale of a portion of the liquid dispenser shown in FIG. 4;
 FIG. 8 is a perspective view of a modified form of liquid dispenser showing my new design;
 FIG. 9 is a side elevational view;
 FIG. 10 is a top plan view;
 FIG. 11 is a front elevational;
 FIG. 12 is a rear elevational view;
 FIG. 13 is a bottom plan view;
 FIG. 14 is a perspective view of another modified form of liquid dispenser showing my new design;
 FIG. 15 is a side elevational view;
 FIG. 16 is a top plan view;
 FIG. 17 is a front elevational;
 FIG. 18 is a rear elevational view;
 FIG. 19 is a bottom plan view;
 FIG. 20 is a perspective view of another form of liquid dispenser showing my new design;
 FIG. 21 is a side elevational view;
 FIG. 22 is a top plan view;
 FIG. 23 is a front elevational;
 FIG. 24 is a rear elevational view; and,
 FIG. 25 is a bottom plan view.

1 Claim, 4 Drawing Sheets

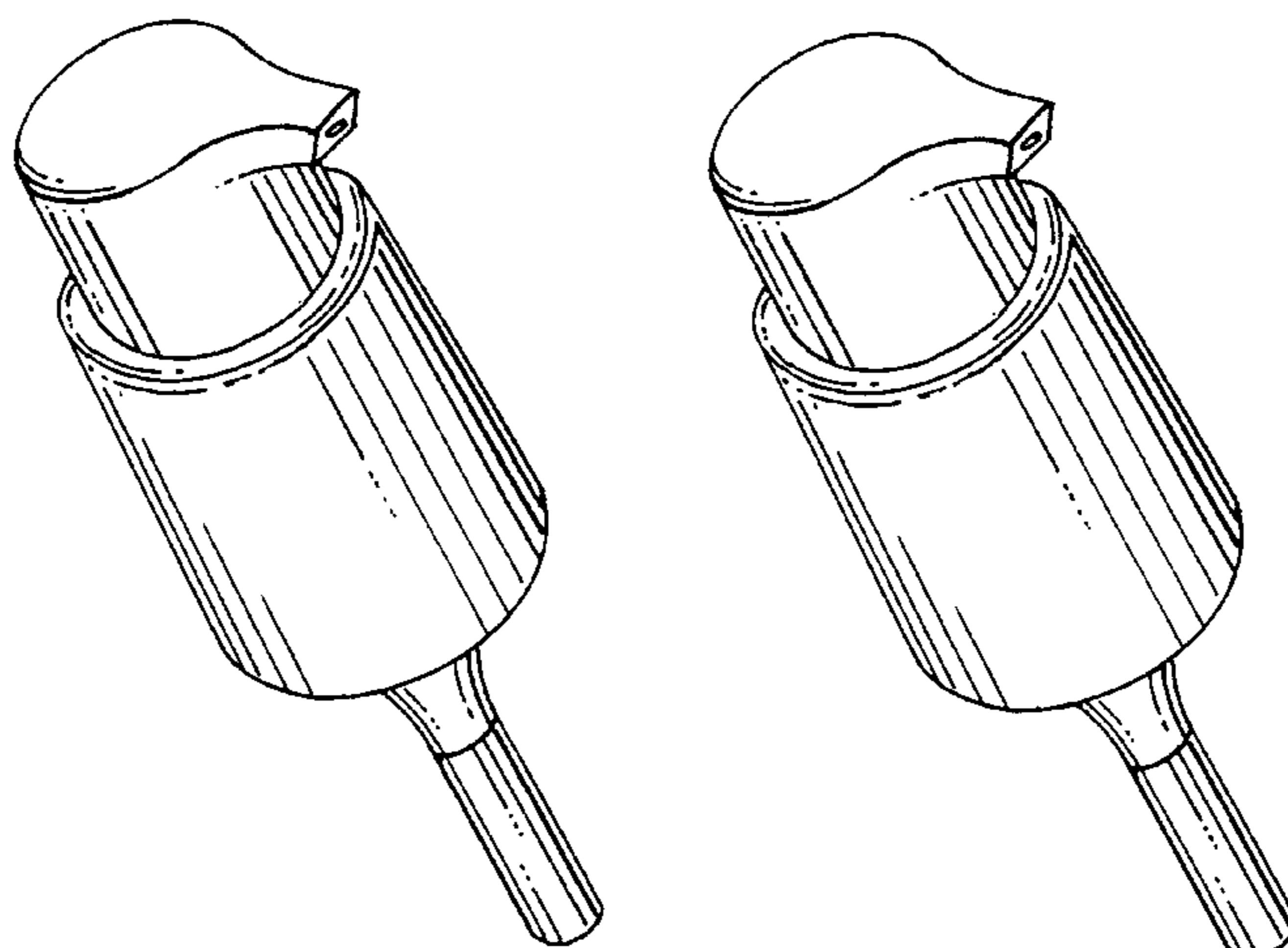

US D441,654 S

Page 2

U.S. PATENT DOCUMENTS

1,756,279	4/1930	Campbell, Jr. .	4,516,727	5/1985	Saito et al. .
1,788,795	1/1931	Hoban .	4,591,076	5/1986	Iizuka .
2,150,485	3/1939	Bernhardt .	4,606,479	8/1986	Van Brocklin .
2,231,779	2/1941	Swartzel .	4,817,829	4/1989	Fuchs et al. .
3,062,416	11/1962	Coopriider .	4,889,262	12/1989	Toms .
3,146,920	9/1964	Benjamin .	4,958,752 *	9/1990	Maerte et al. 222/385 X
3,180,535	4/1965	Ward .	5,088,629	2/1992	O'Neill .
3,229,864	1/1966	Roder .	5,092,495	3/1992	Andre .
3,323,695	6/1967	Monahon .	5,163,588	11/1992	Cater .
3,724,726	4/1973	Susuki .	5,234,135	8/1993	LaFosse et al. .
3,759,426	9/1973	Kane .	5,301,852	4/1994	Mancini .
3,908,870	9/1975	Nozawa et al. .	5,326,000	7/1994	Fuchs .
4,144,987	3/1979	Kishi .	5,335,830	8/1994	Cater .
4,183,449	1/1980	Blake .	5,348,189	9/1994	Cater .
4,368,830	1/1983	Soughers .	5,388,766	2/1995	Buisson .
4,371,099	2/1983	Foster et al. .	5,449,094	9/1995	Behar et al. .
4,462,549	7/1984	Saito et al. .	5,518,147 *	5/1996	Peterson et al. 222/153.07
4,511,065	4/1985	Corsette .	5,615,806 *	4/1997	Grothoff 222/153.13

* cited by examiner

FIG. 1

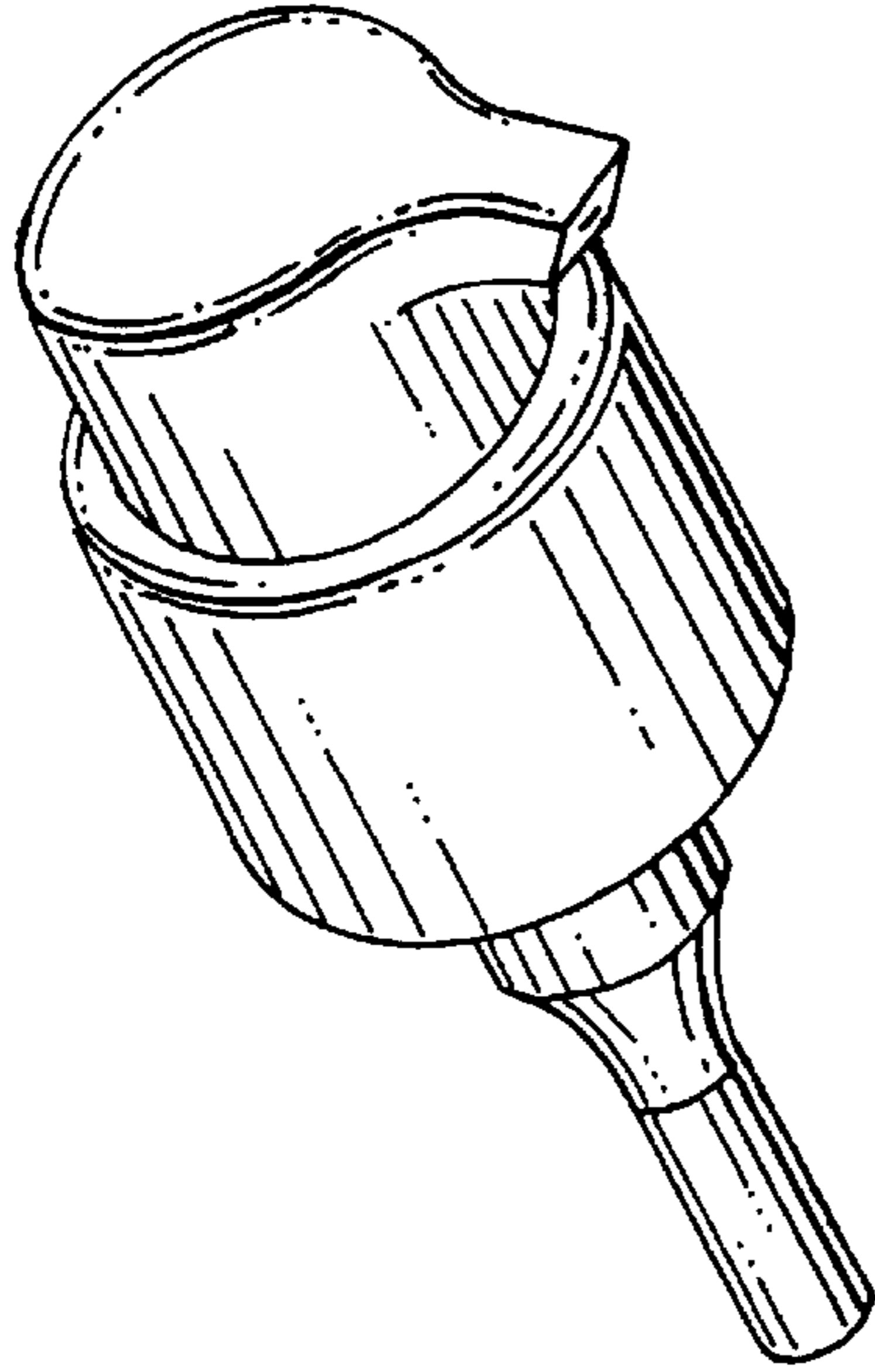

FIG. 2

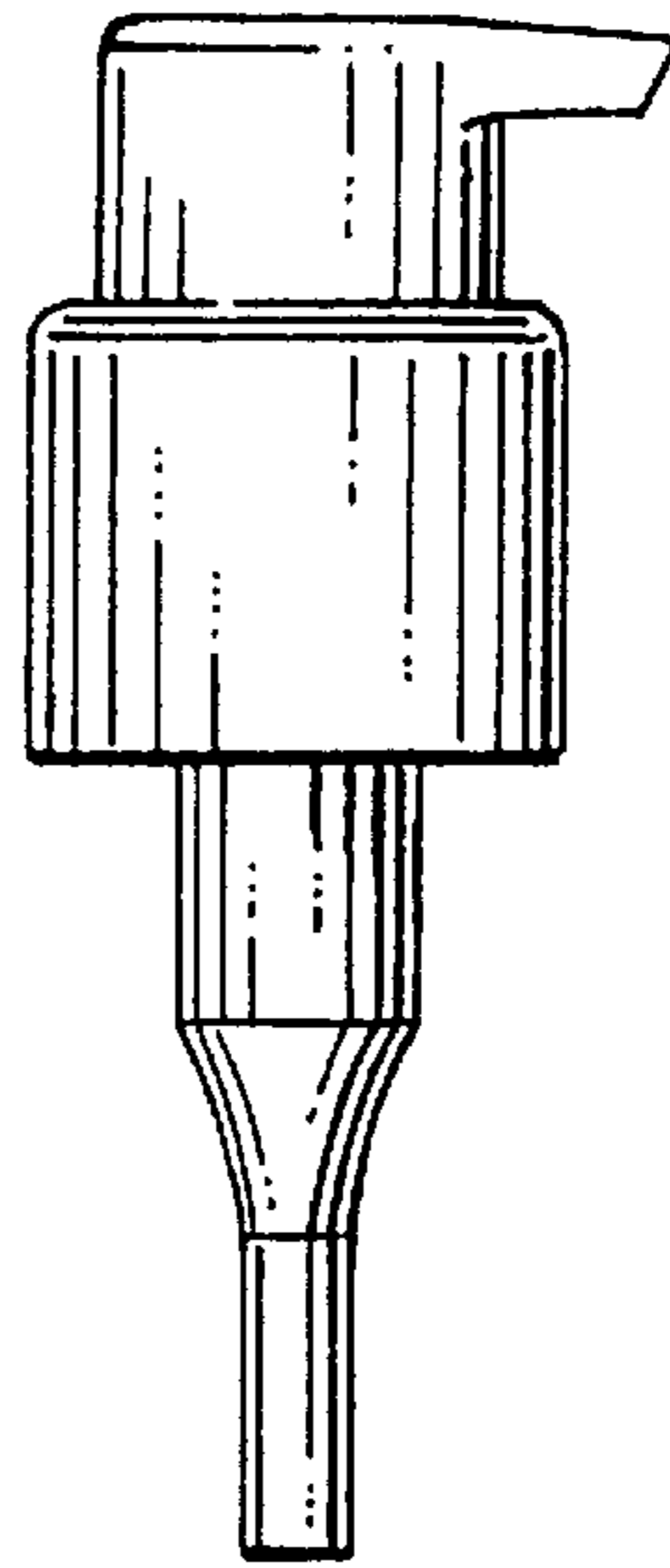

FIG. 3

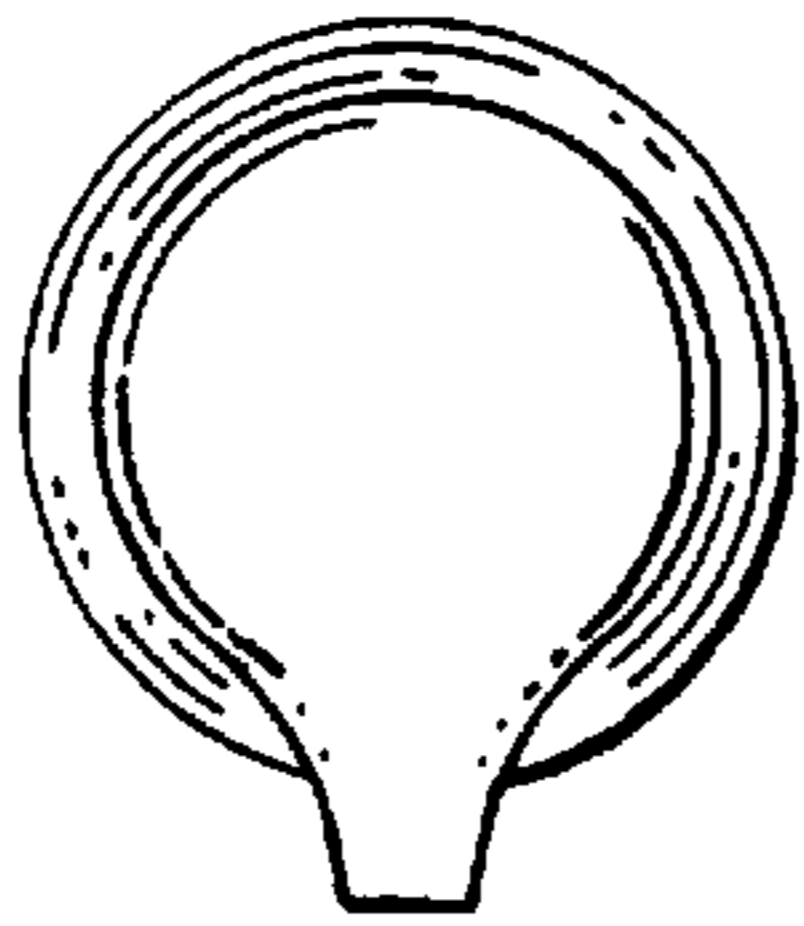

FIG. 6

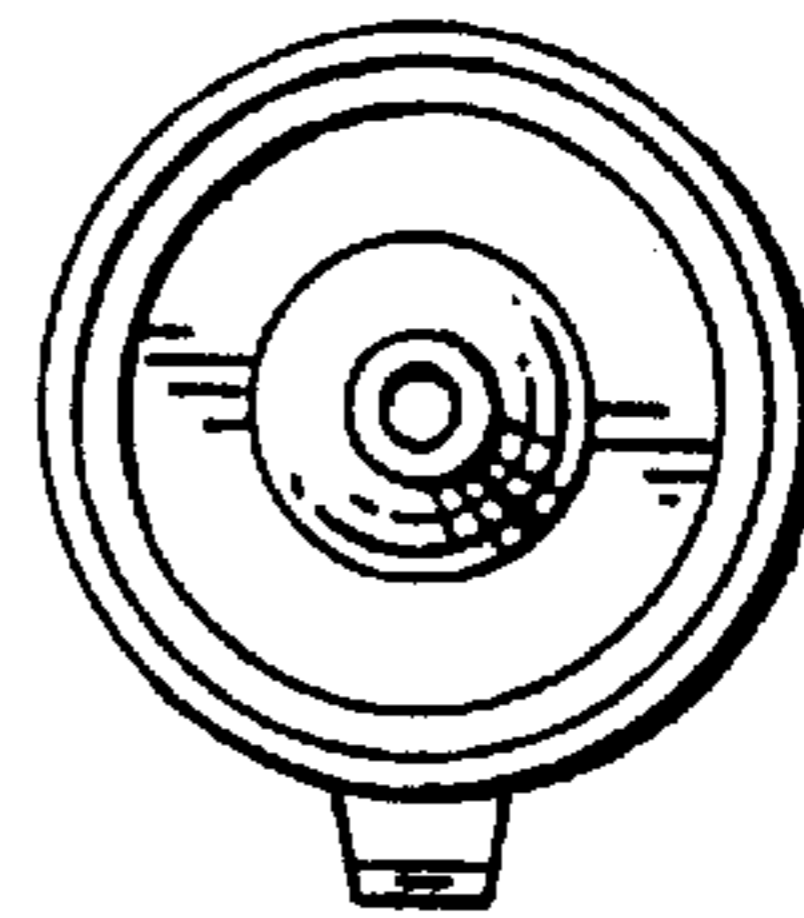

FIG. 4

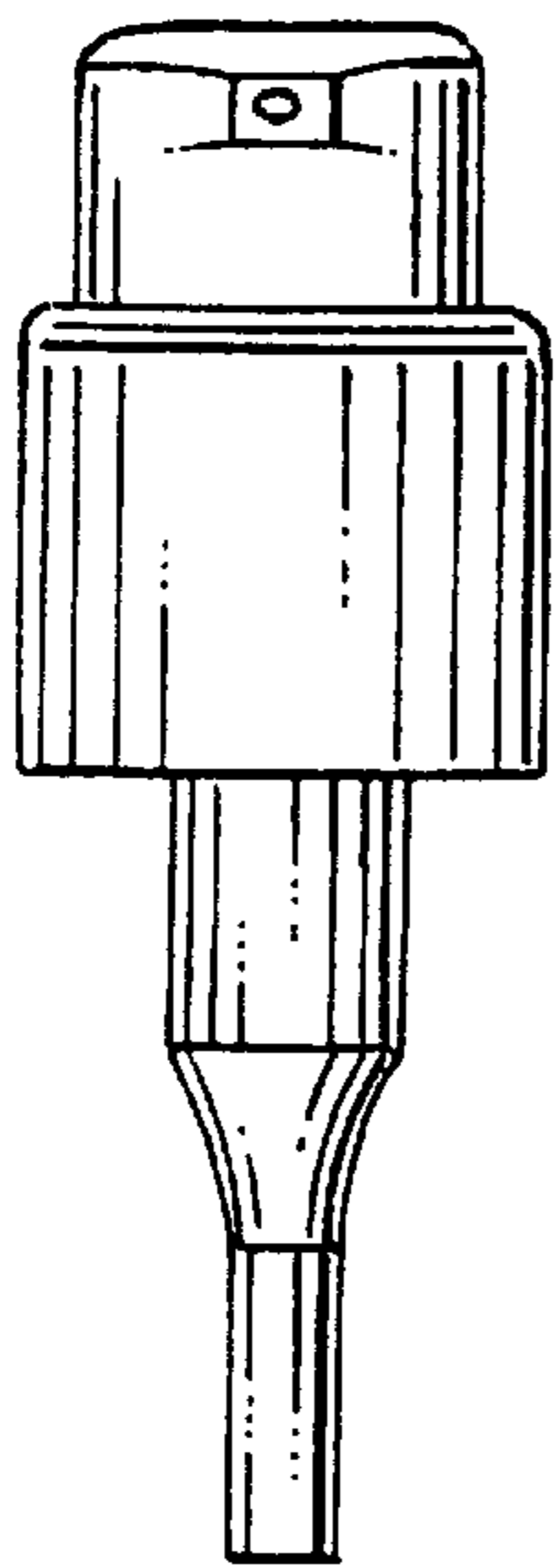

FIG. 5

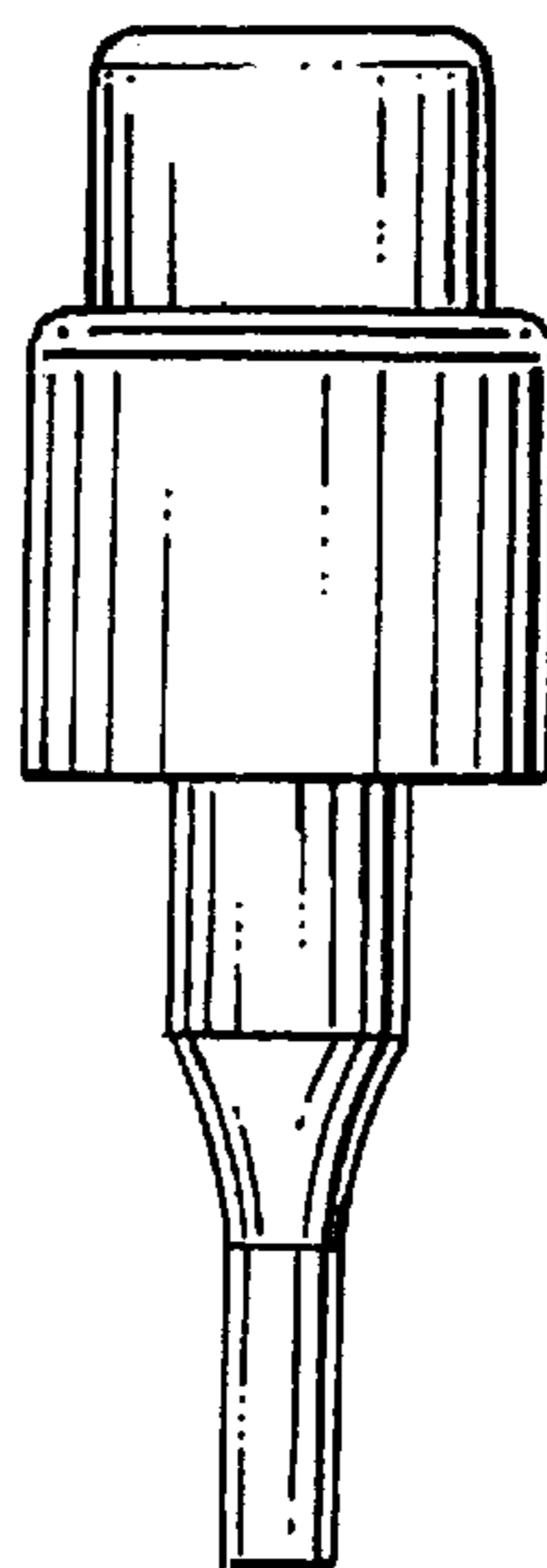

FIG. 7

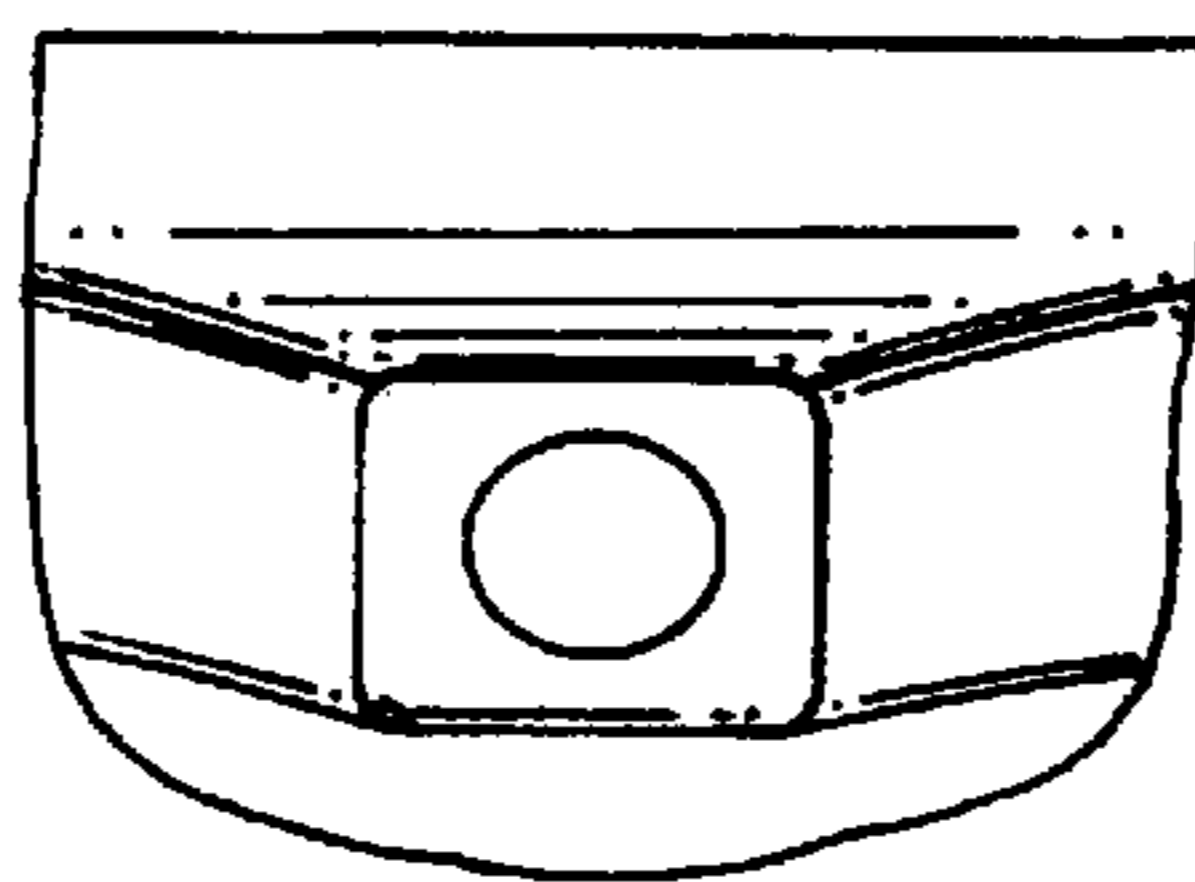

FIG. 8

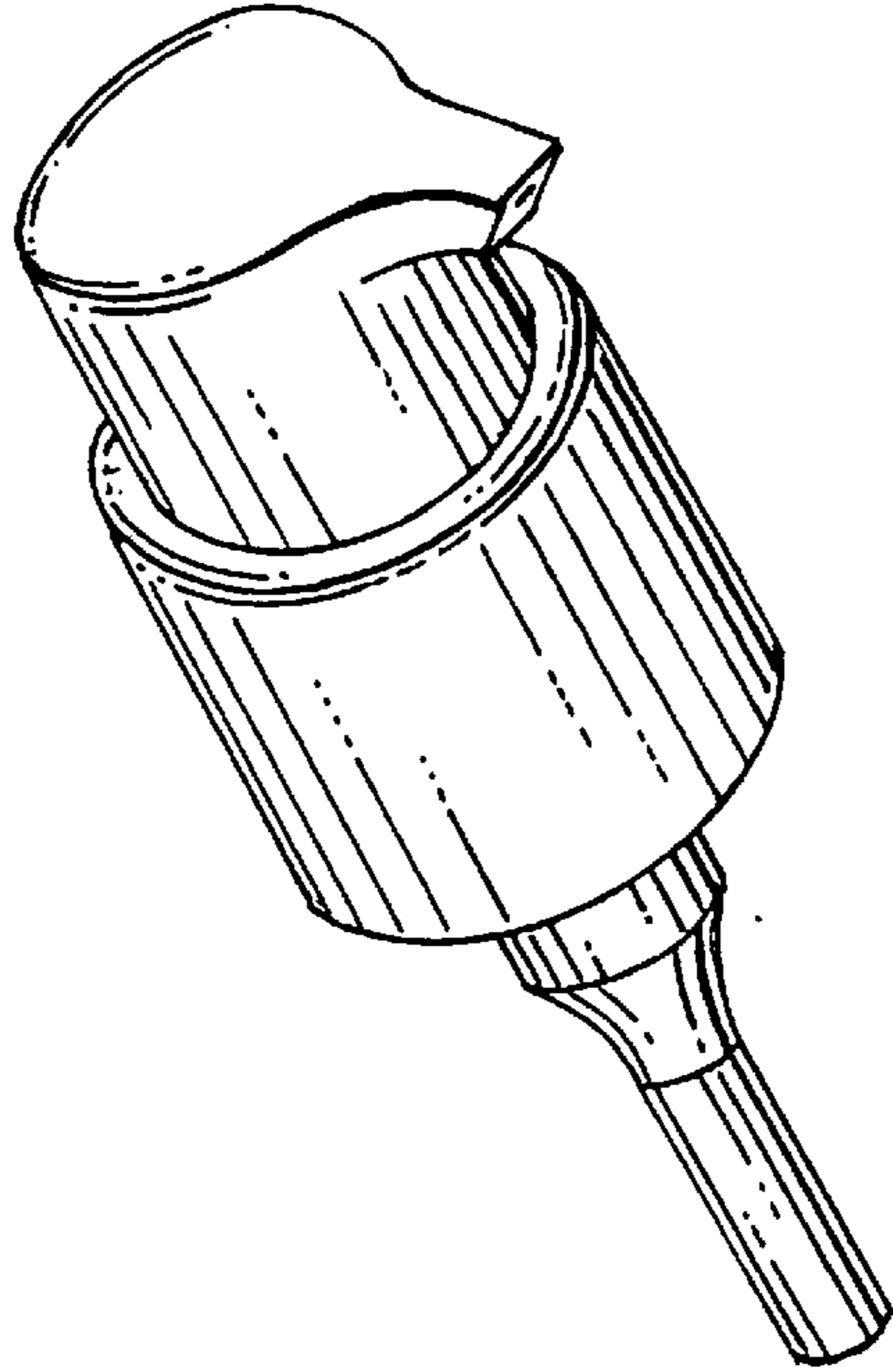

FIG. 9

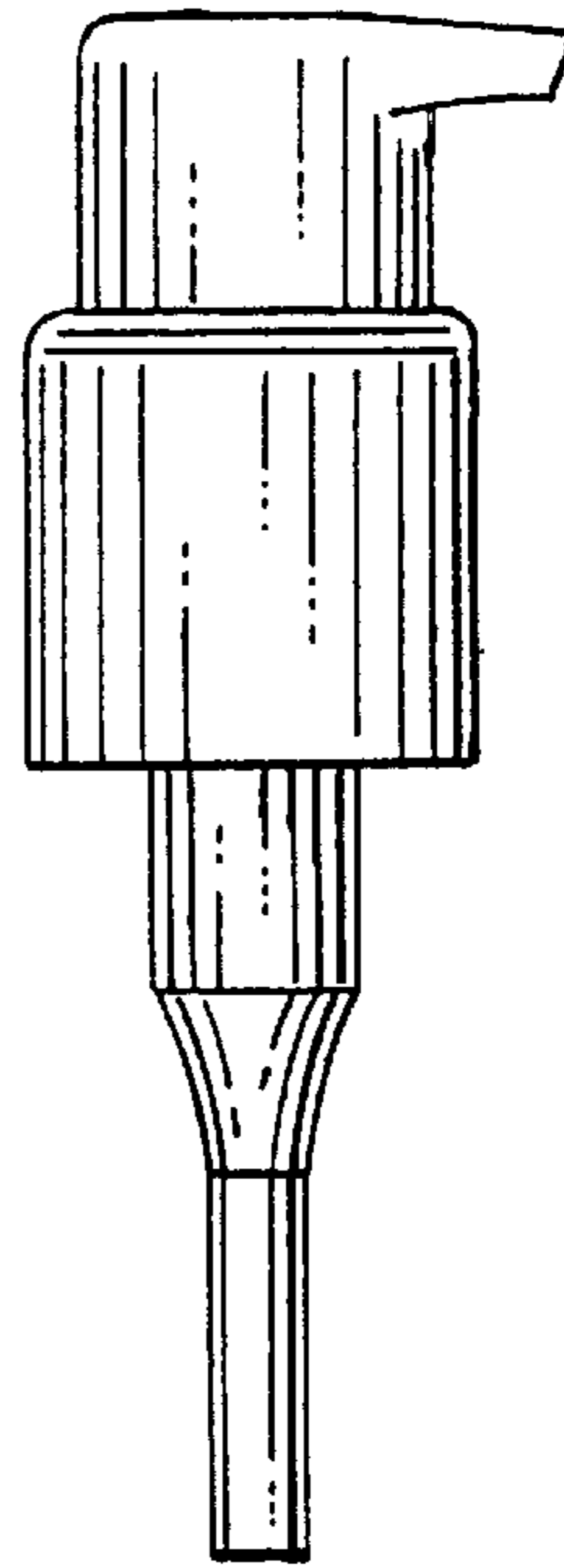

FIG. 10

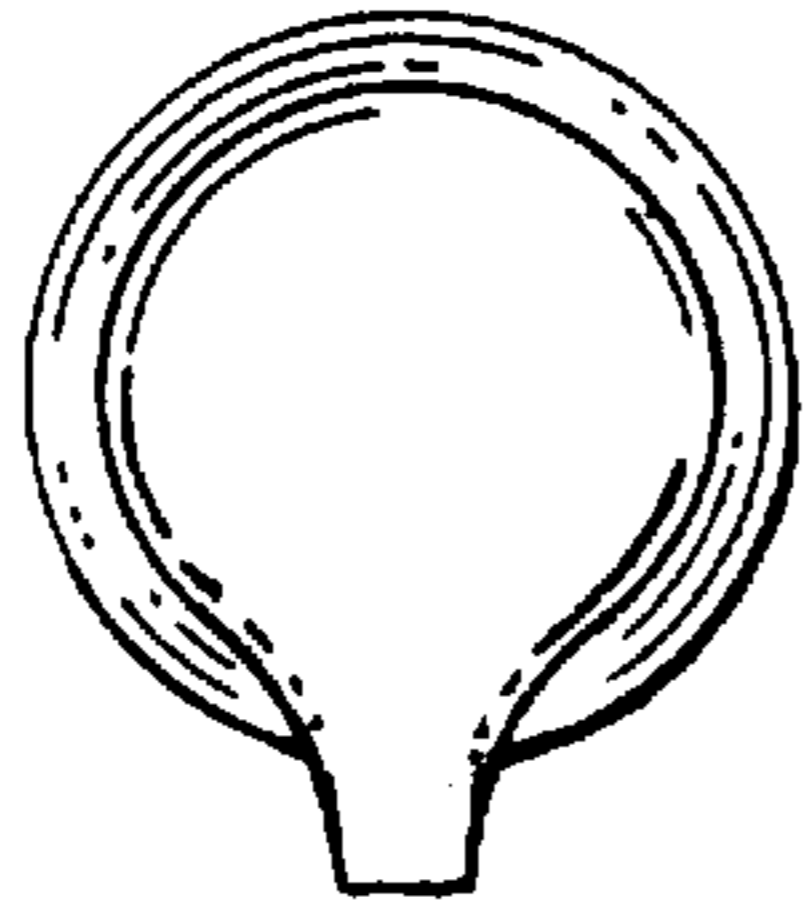

FIG. 13

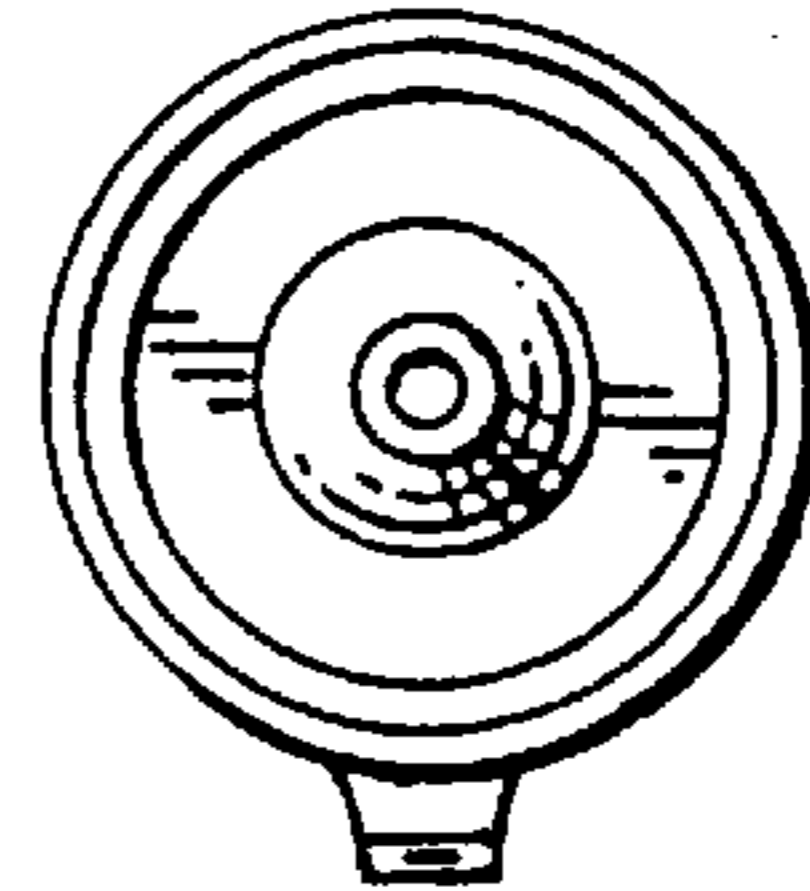

FIG. 11

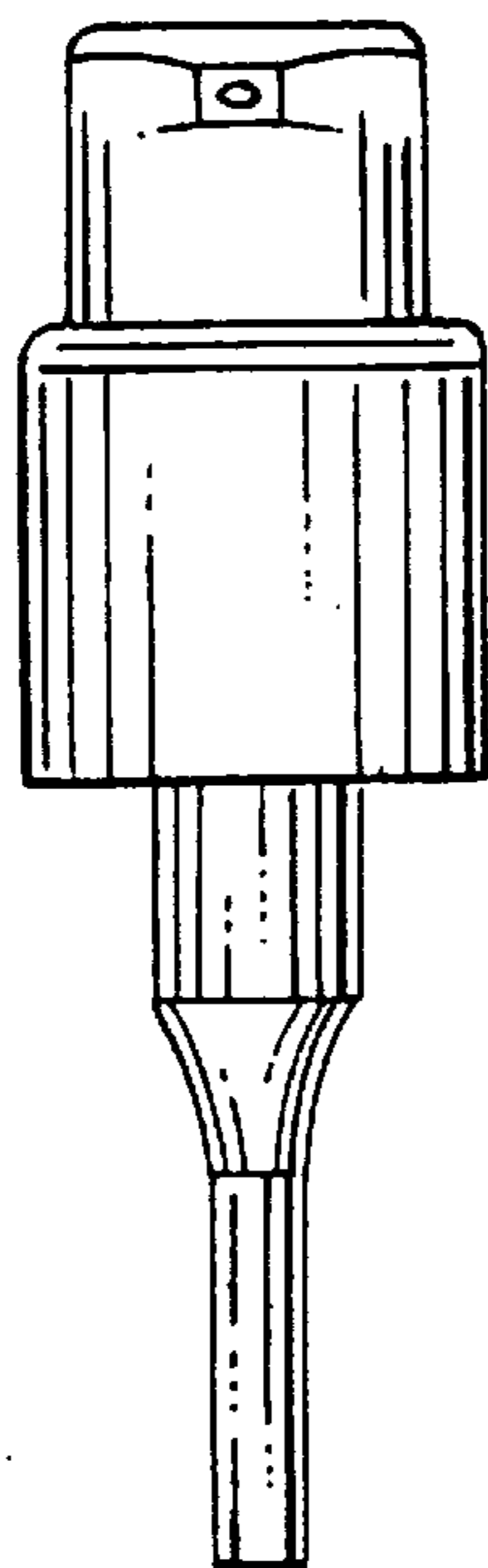

FIG. 12

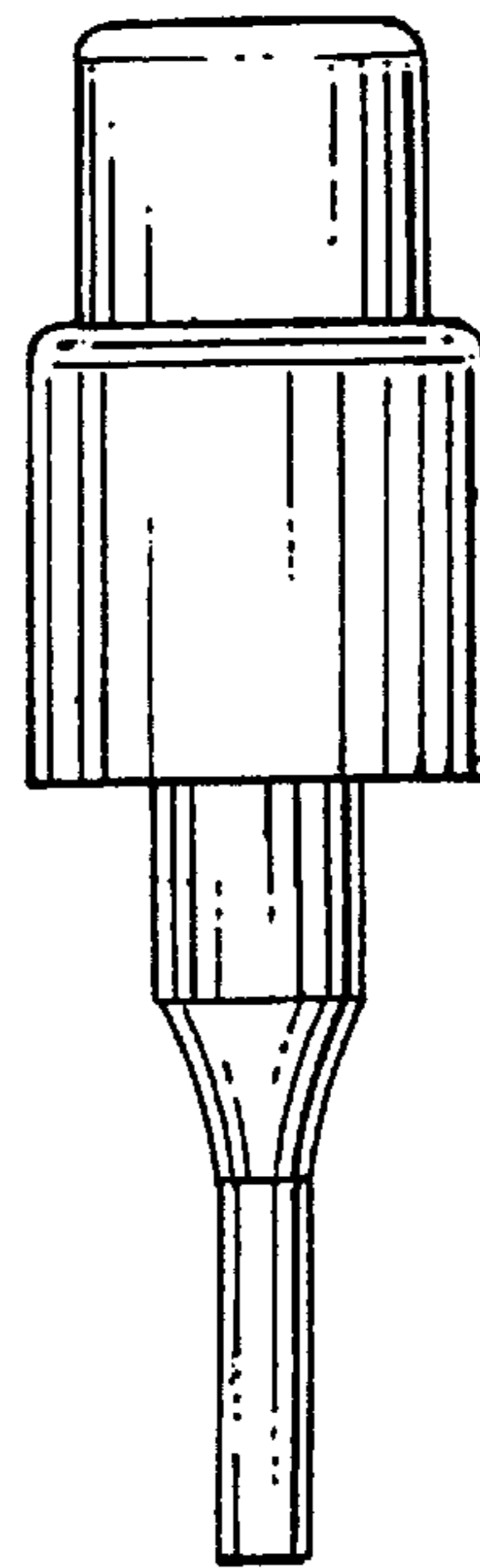

FIG.14

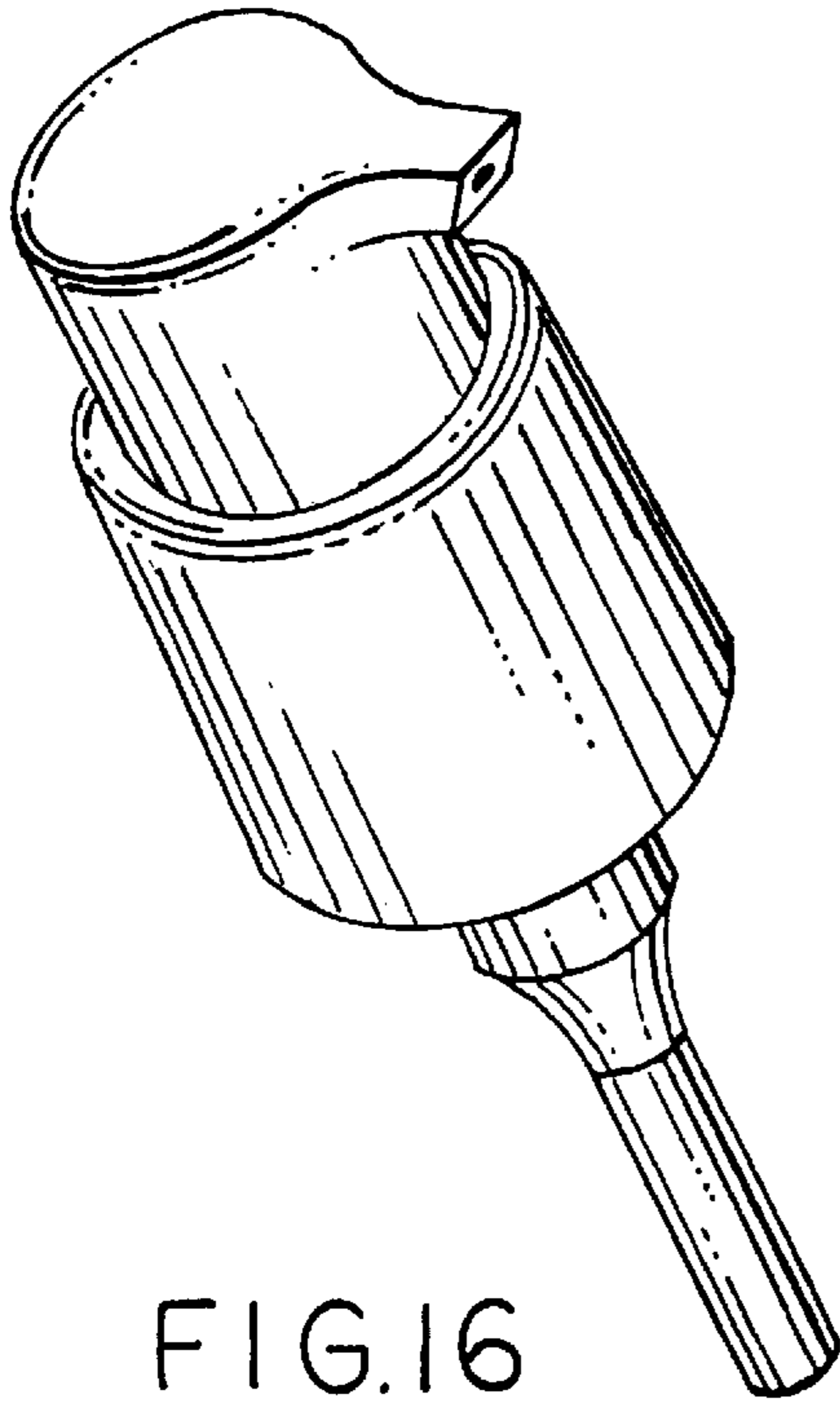

FIG.15

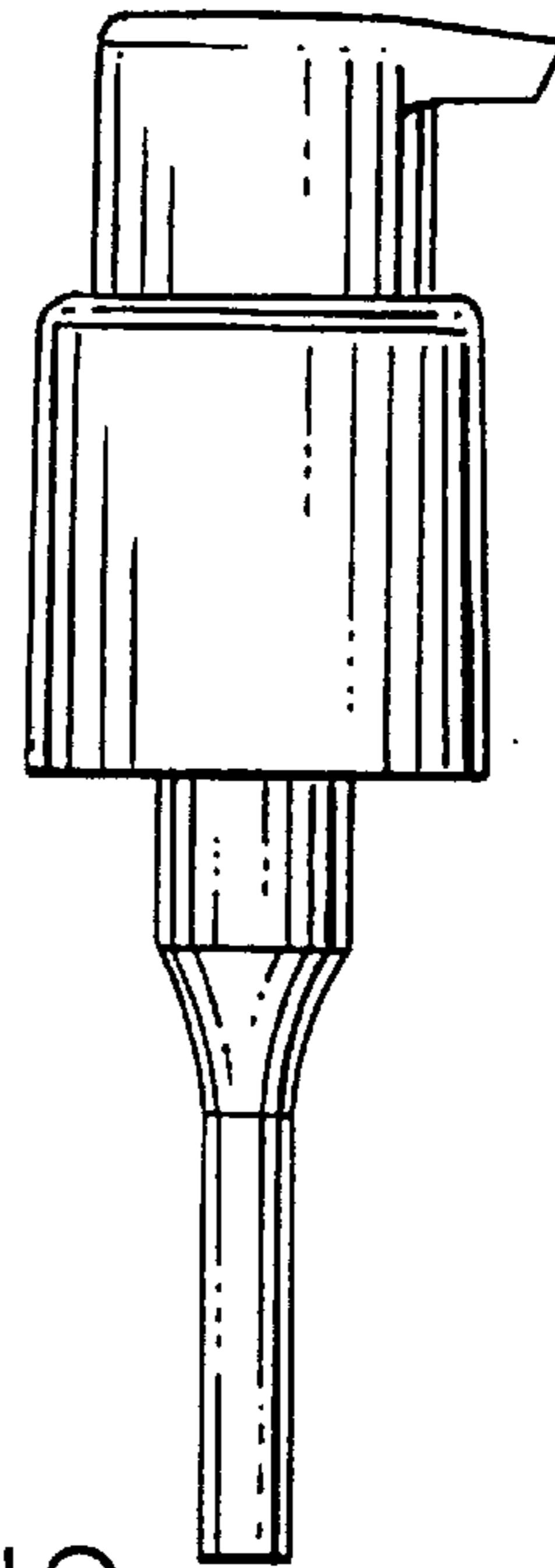

FIG.16

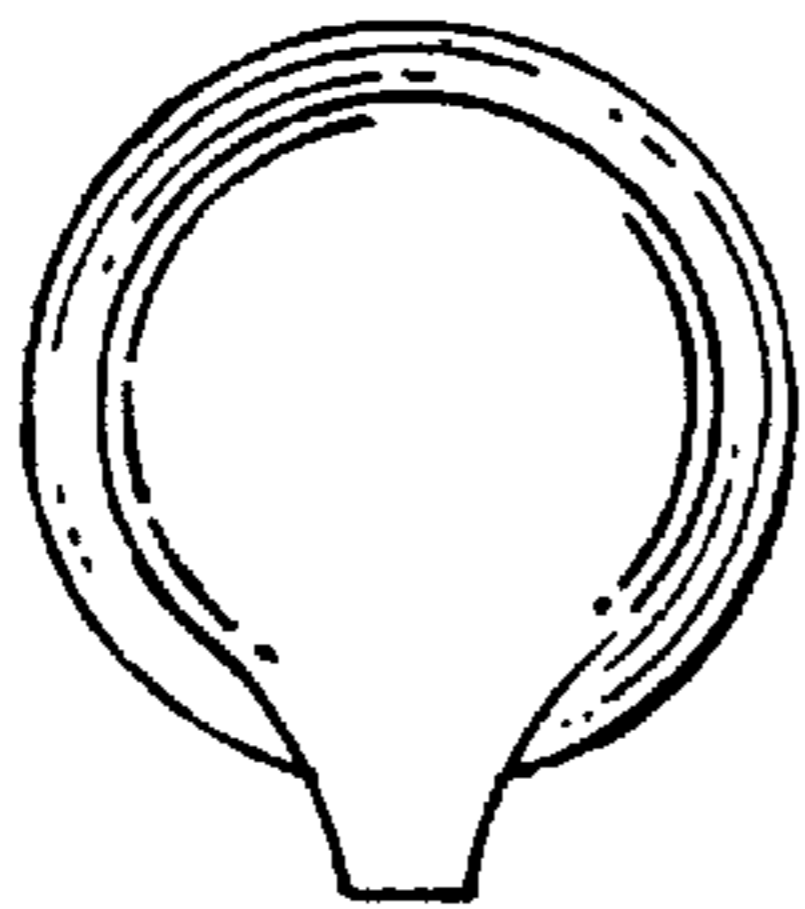

FIG.19

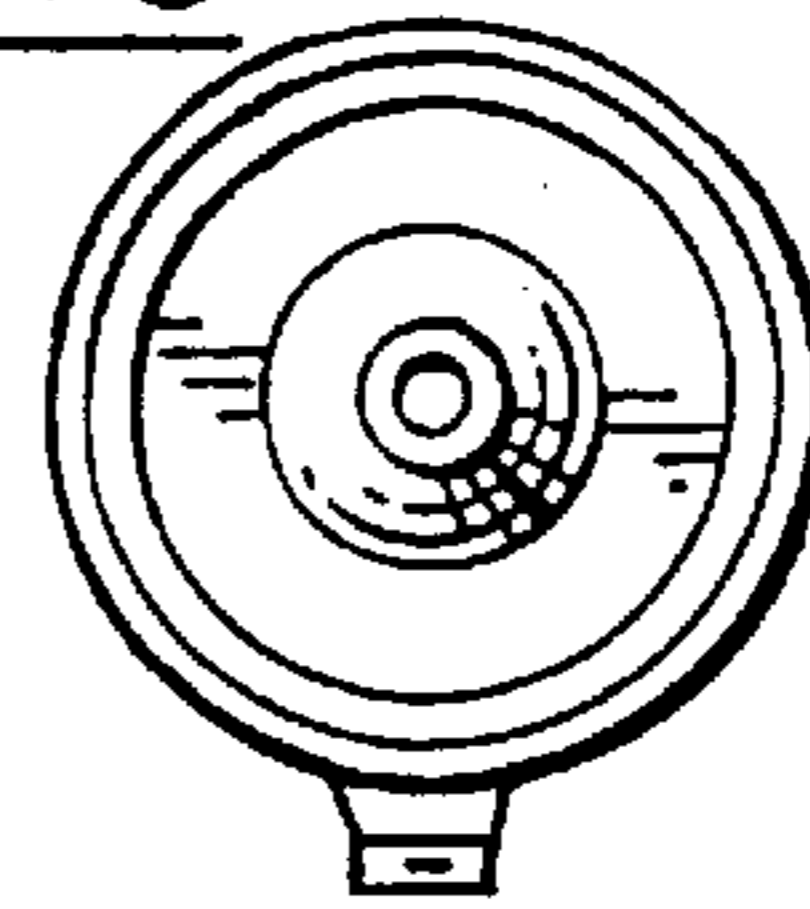

FIG.17

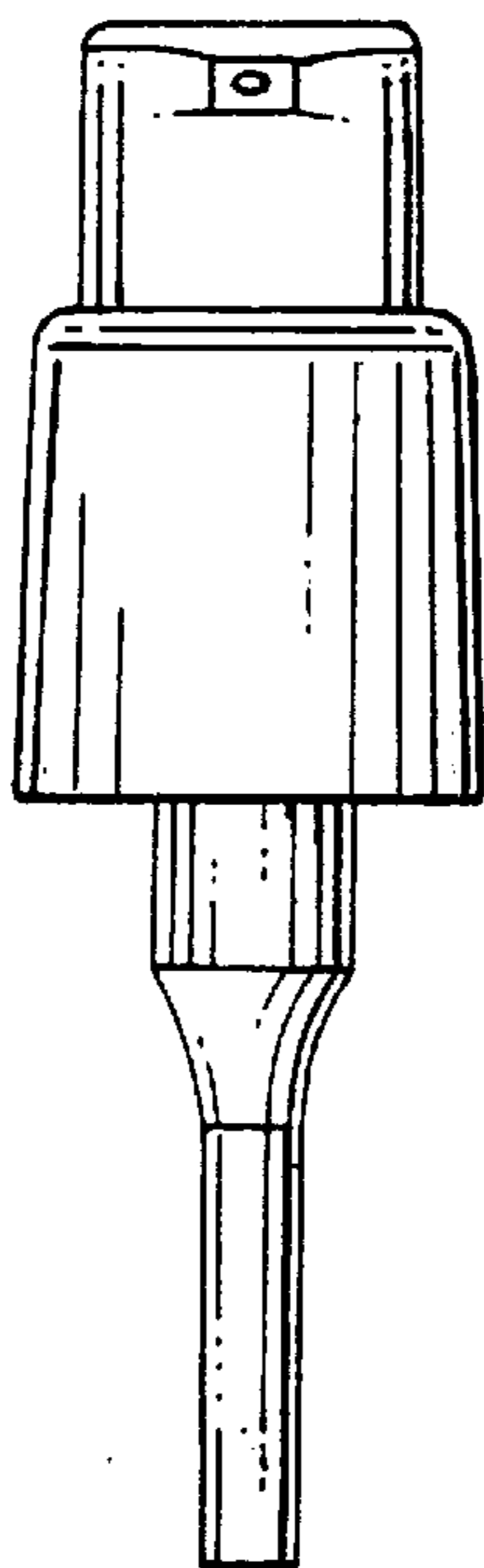

FIG.18

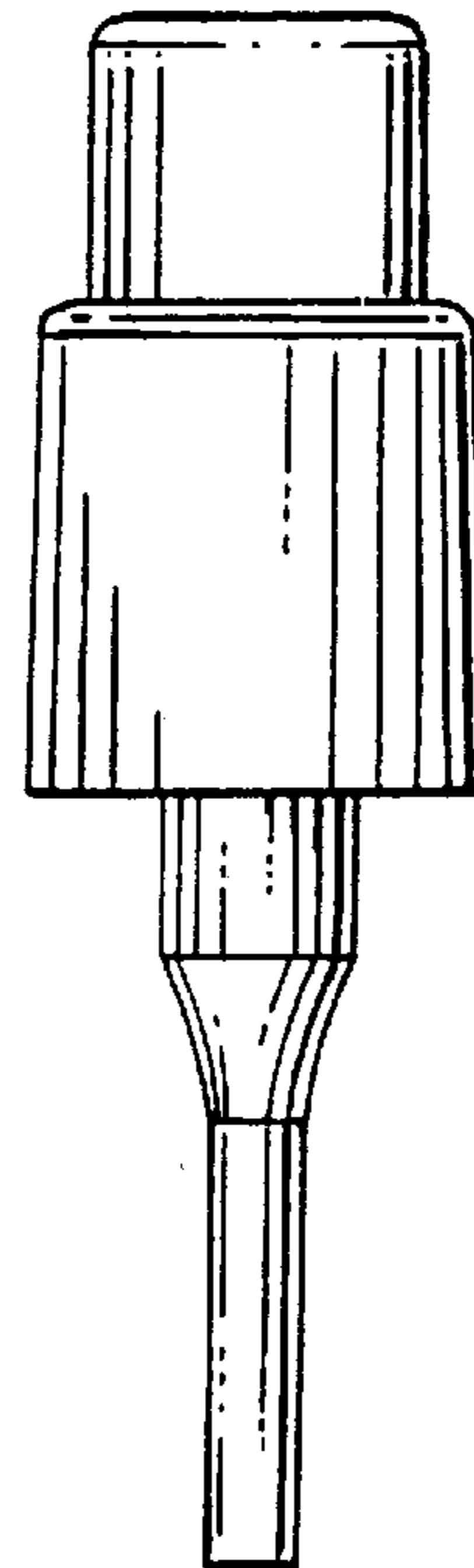

FIG.20

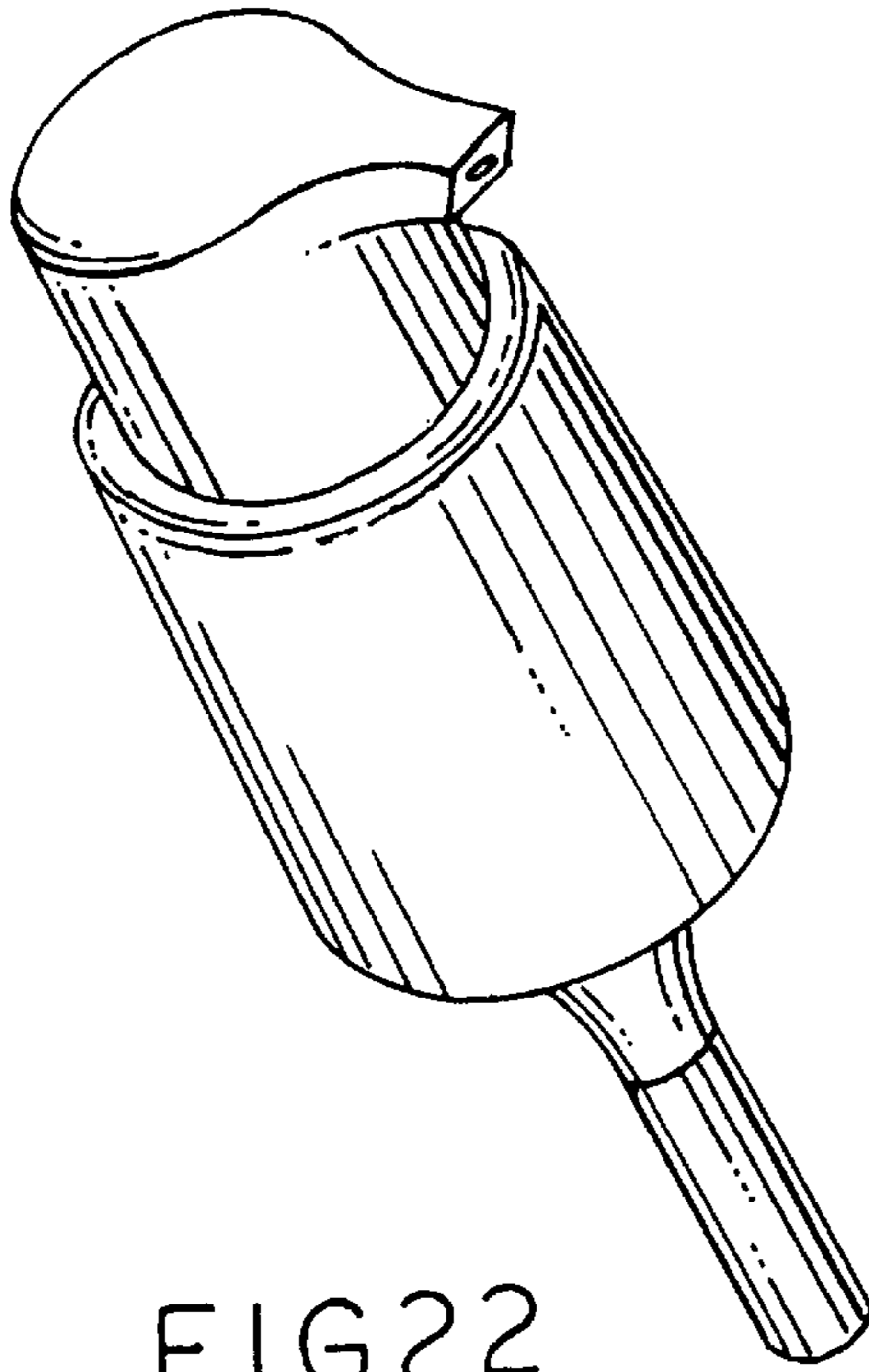

FIG.21

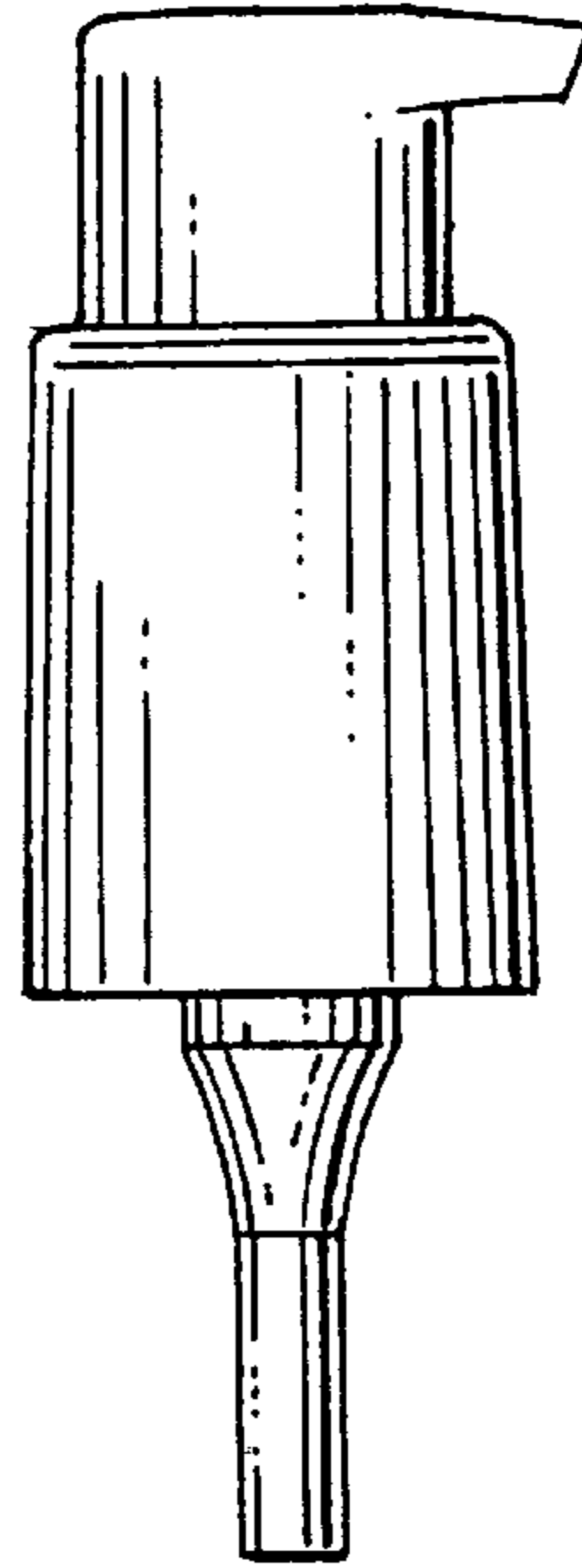

FIG.22

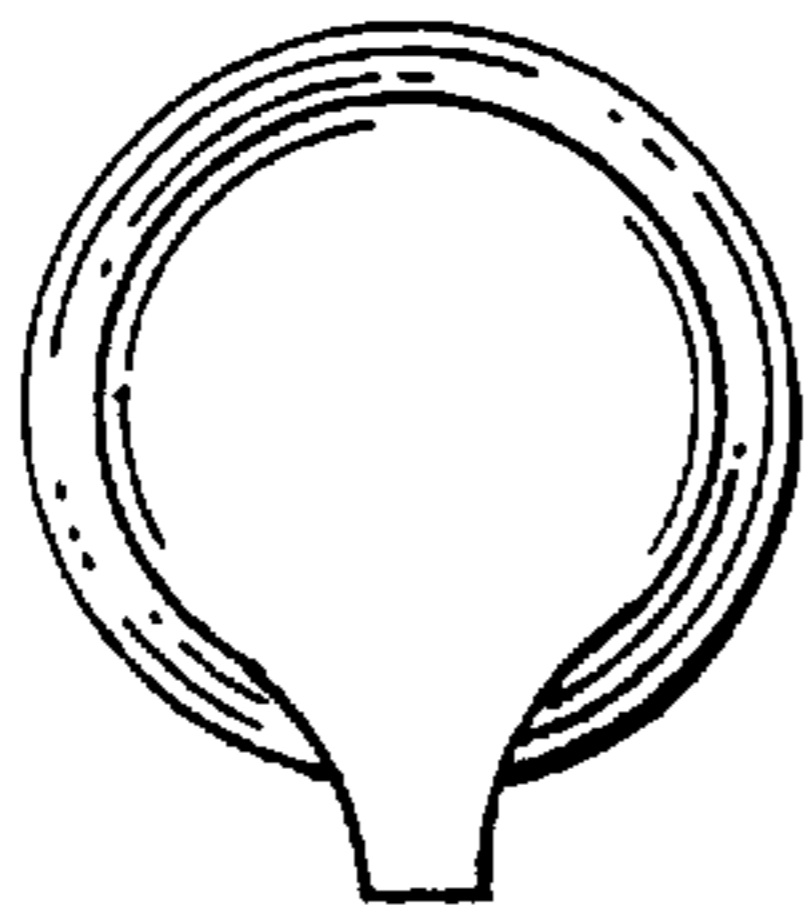

FIG.25

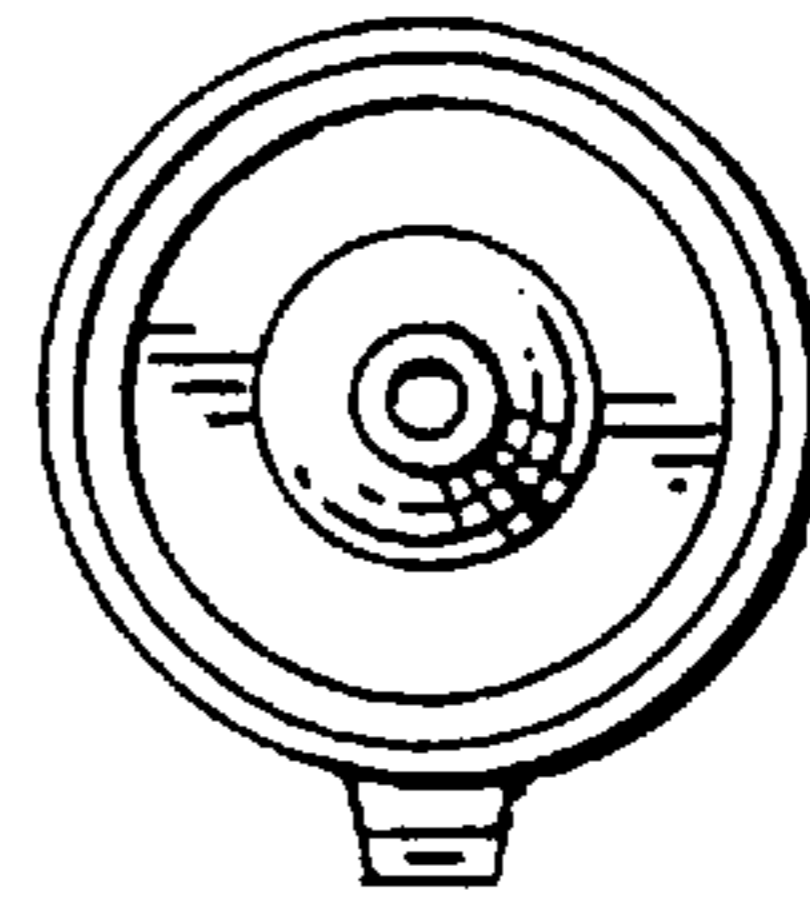

FIG.23

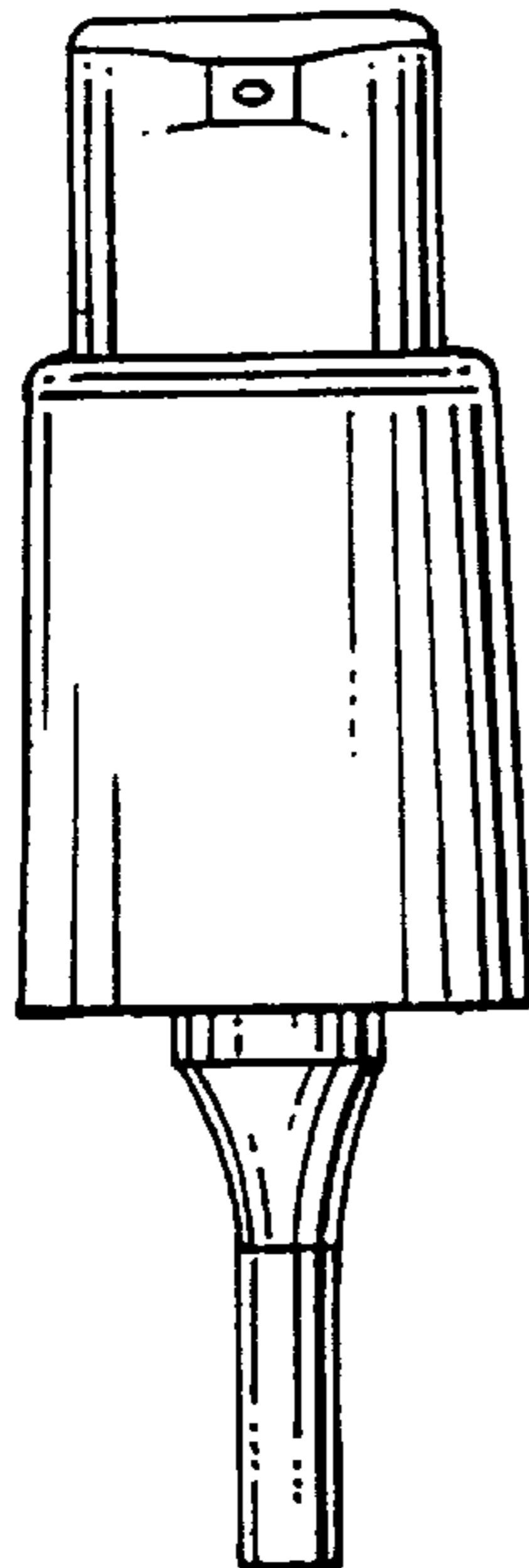

FIG.24

