



US00D441643S

(12) **United States Design Patent**
Tsuruishi et al.

(10) **Patent No.:** **US D441,643 S**

(45) **Date of Patent:** **** May 8, 2001**

(54) **DISPLAY CARTON**

3,250,455 * 5/1966 Plunkett D9/432

(75) Inventors: **Hideaki Tsuruishi**, Yokohama; **Keita Yoshida**, Tokyo; **Tomomi Yoshida**, Yokohama, all of (JP)

(73) Assignee: **Canon Kabushiki Kaisha**, Tokyo (JP)

(**) Term: **14 Years**

(21) Appl. No.: **29/126,496**

(22) Filed: **Jul. 19, 2000**

(30) **Foreign Application Priority Data**

Feb. 3, 2000 (JP) 12-005164

(51) **LOC (7) Cl.** **09-03**

(52) **U.S. Cl.** **D9/346**

(58) **Field of Search** D9/341-346, 415, D9/430, 432, 433; 206/45.2, 45.29, 45.3

(56) **References Cited**

U.S. PATENT DOCUMENTS

- D. 255,993 * 7/1980 Lambert D9/433
- D. 317,070 * 5/1991 Ott et al. D9/346
- D. 366,210 * 1/1996 McConner D9/432
- 1,799,656 * 4/1931 Tinsley 206/45.3
- 2,024,702 * 12/1935 Powell 206/45.29
- 2,322,849 * 6/1943 Horr 206/45.29
- 2,457,291 * 12/1948 Wenzel 206/45.29

OTHER PUBLICATIONS

- U.S. Ser. No. 29/126,495, filed Jul. 19, 2000.
- U.S. Ser. No. 29,126,498, filed Jul. 19, 2000.
- U.S. Ser. No. 29,126,494, filed Jul. 19, 2000.

* cited by examiner

Primary Examiner—Raphael Barkai

(74) *Attorney, Agent, or Firm*—Fitzpatrick, Cella, Harper & Scinto

(57) **CLAIM**

The ornamental design for a display carton, as shown and described.

DESCRIPTION

FIG. 1 is a front view of a display carton showing our new design;
 FIG. 2 is a rear view thereof;
 FIG. 3 is a top plan view thereof;
 FIG. 4 is a bottom plan view thereof;
 FIG. 5 is a left side view thereof;
 FIG. 6 is a right side view thereof; and,
 FIG. 7 is a perspective view as viewed from right and front thereof.

The broken lines shown in FIGS. 1-7 are for illustrative purposes only and form no part of the claimed design.

1 Claim, 4 Drawing Sheets

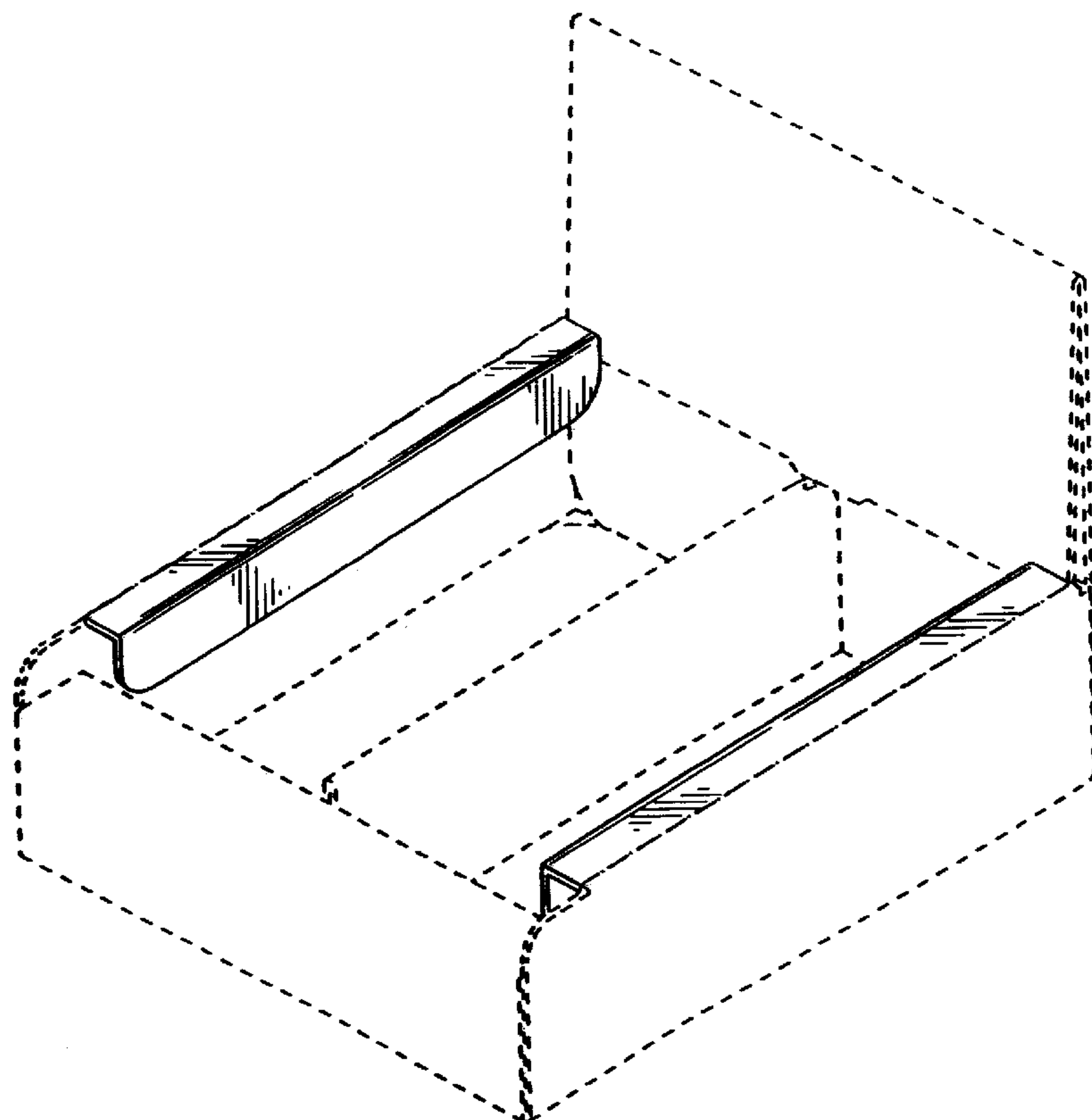

FIG. 1

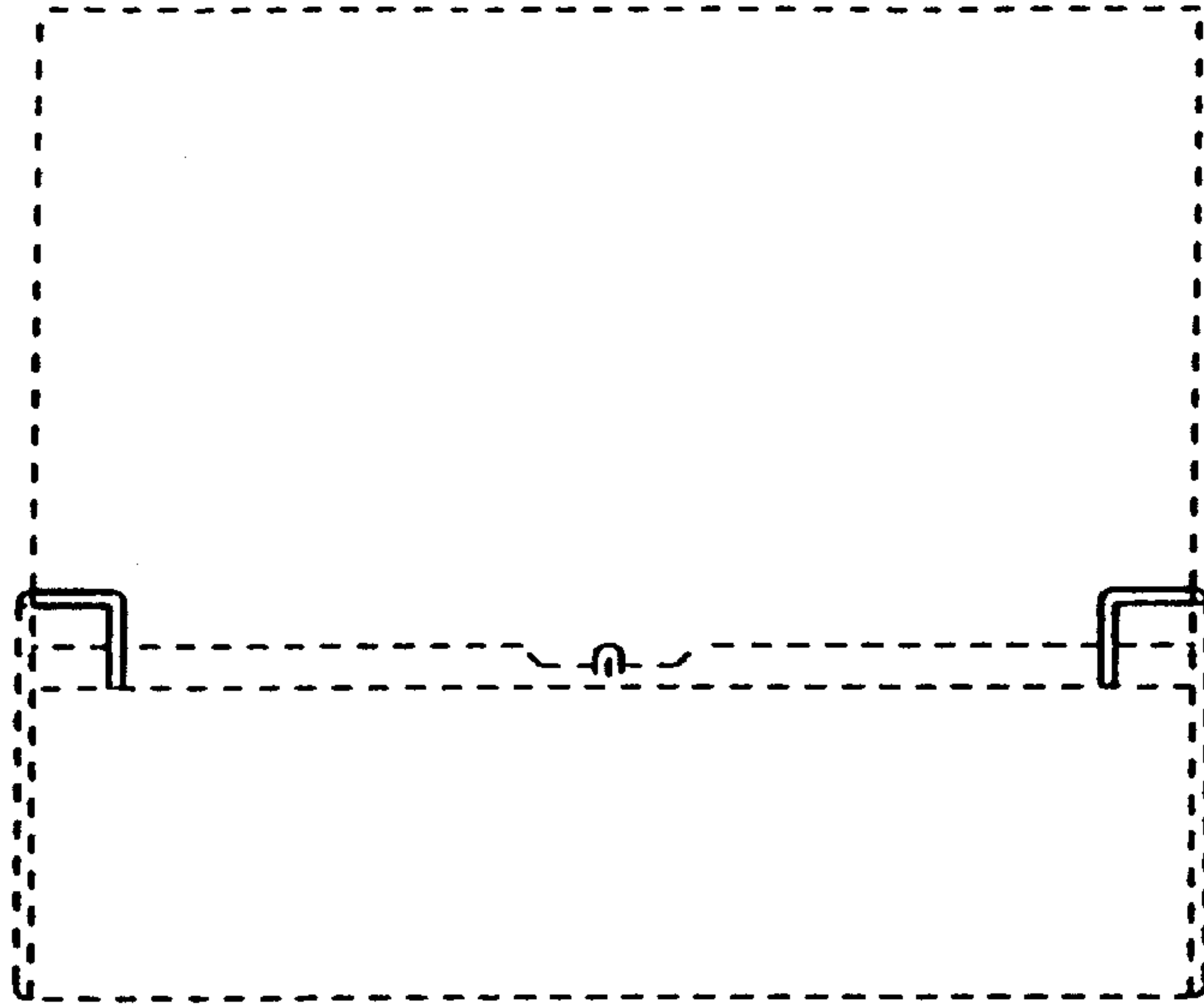

FIG. 2

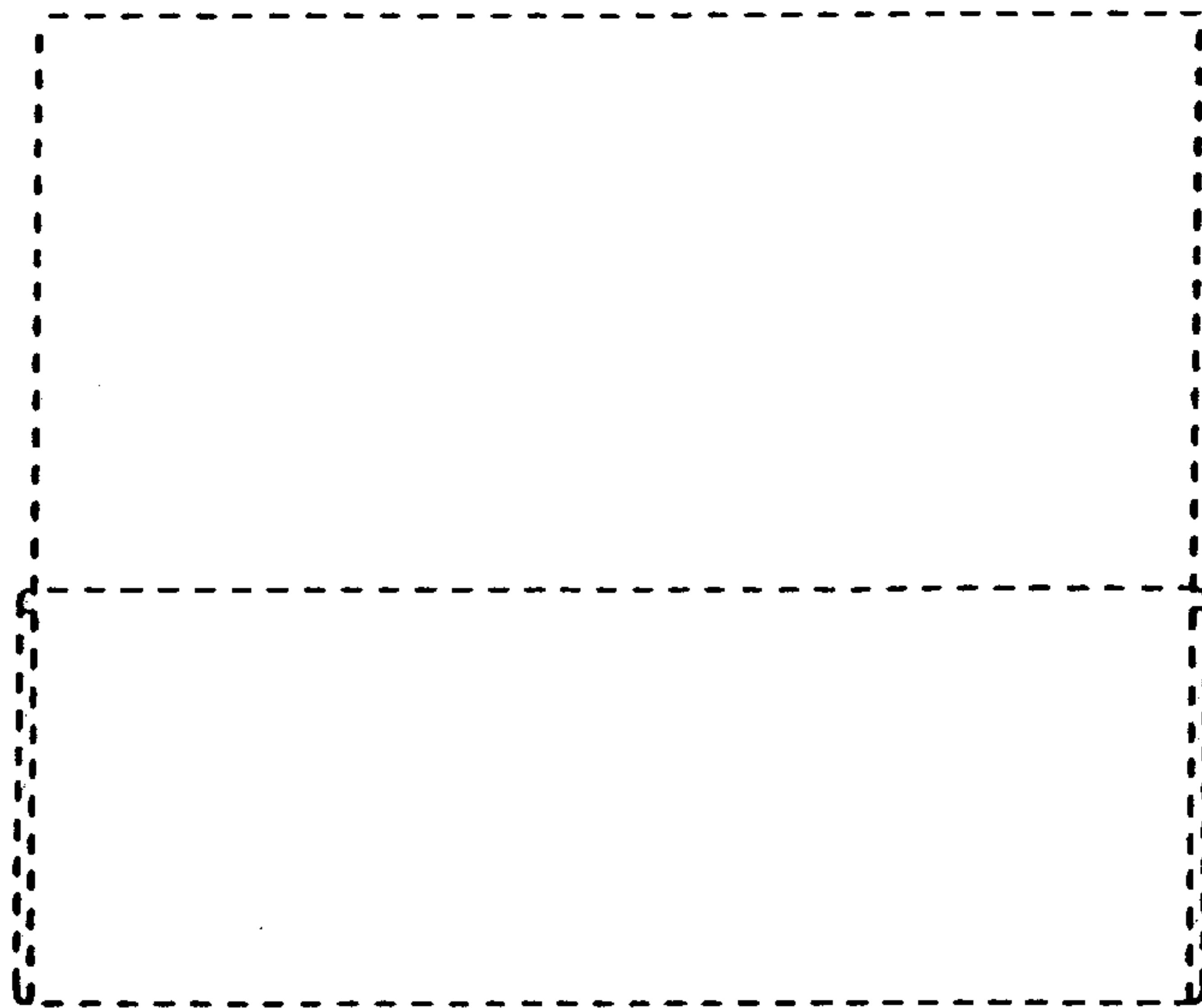

FIG. 3

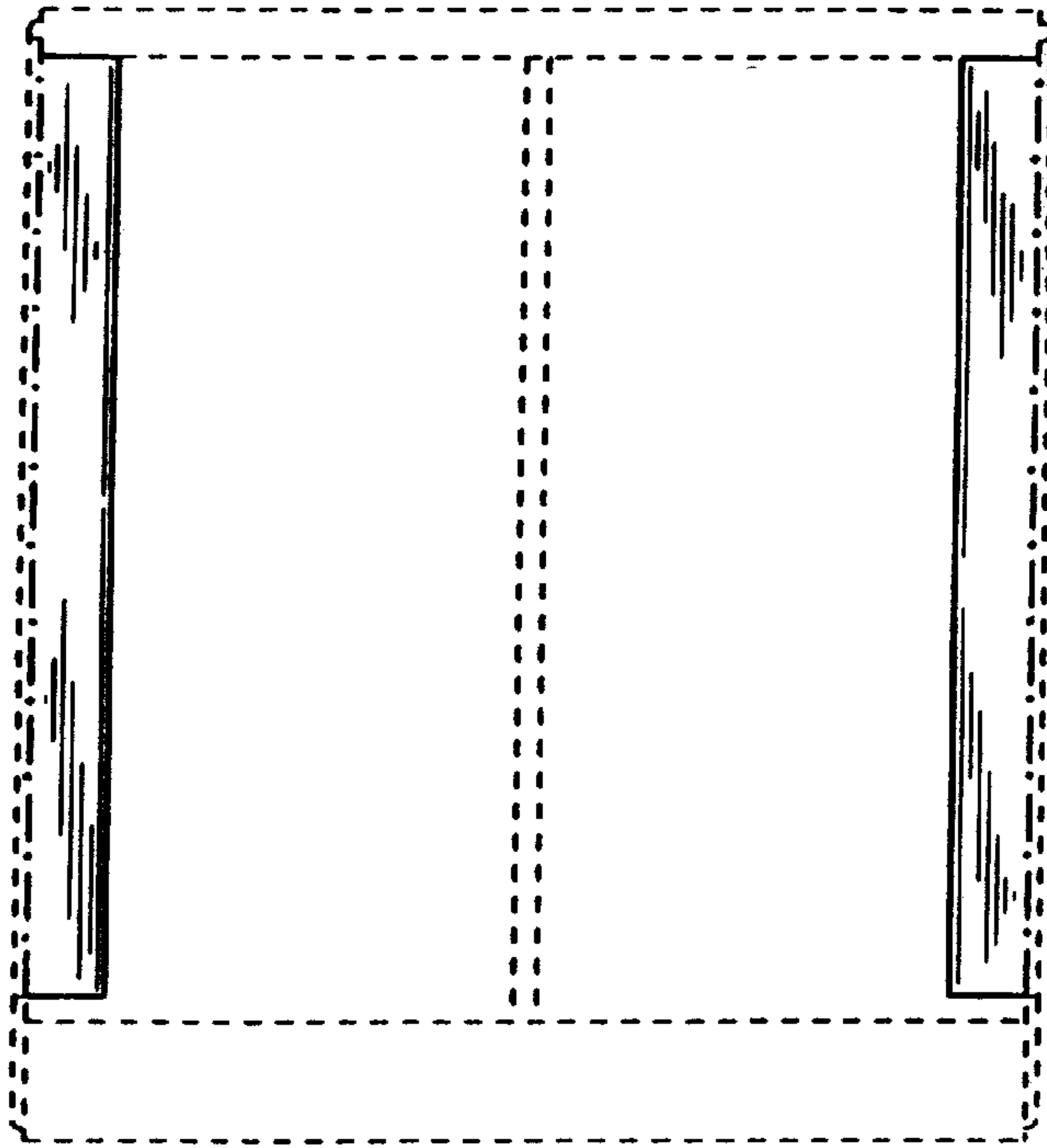

FIG. 4

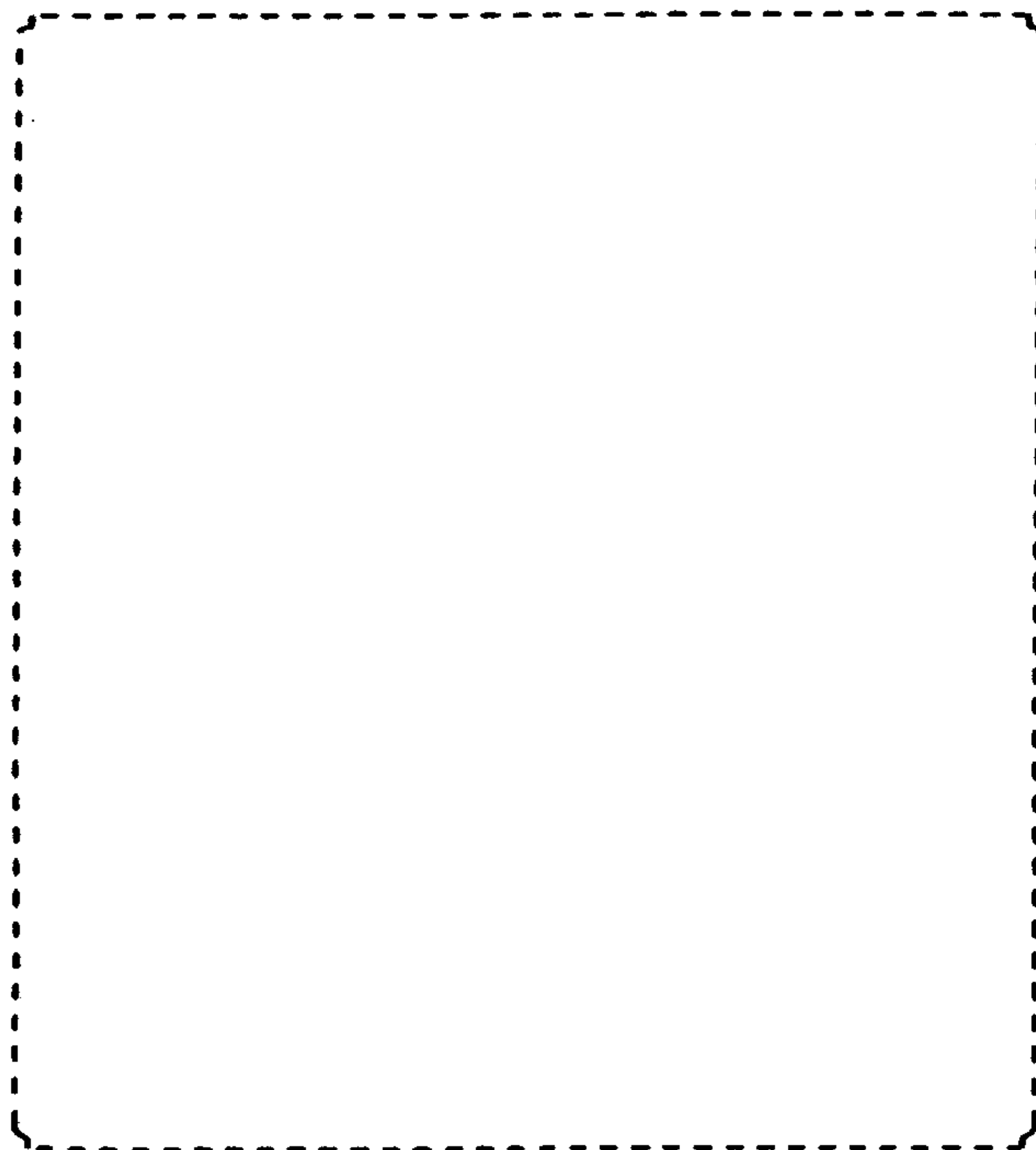

FIG. 5

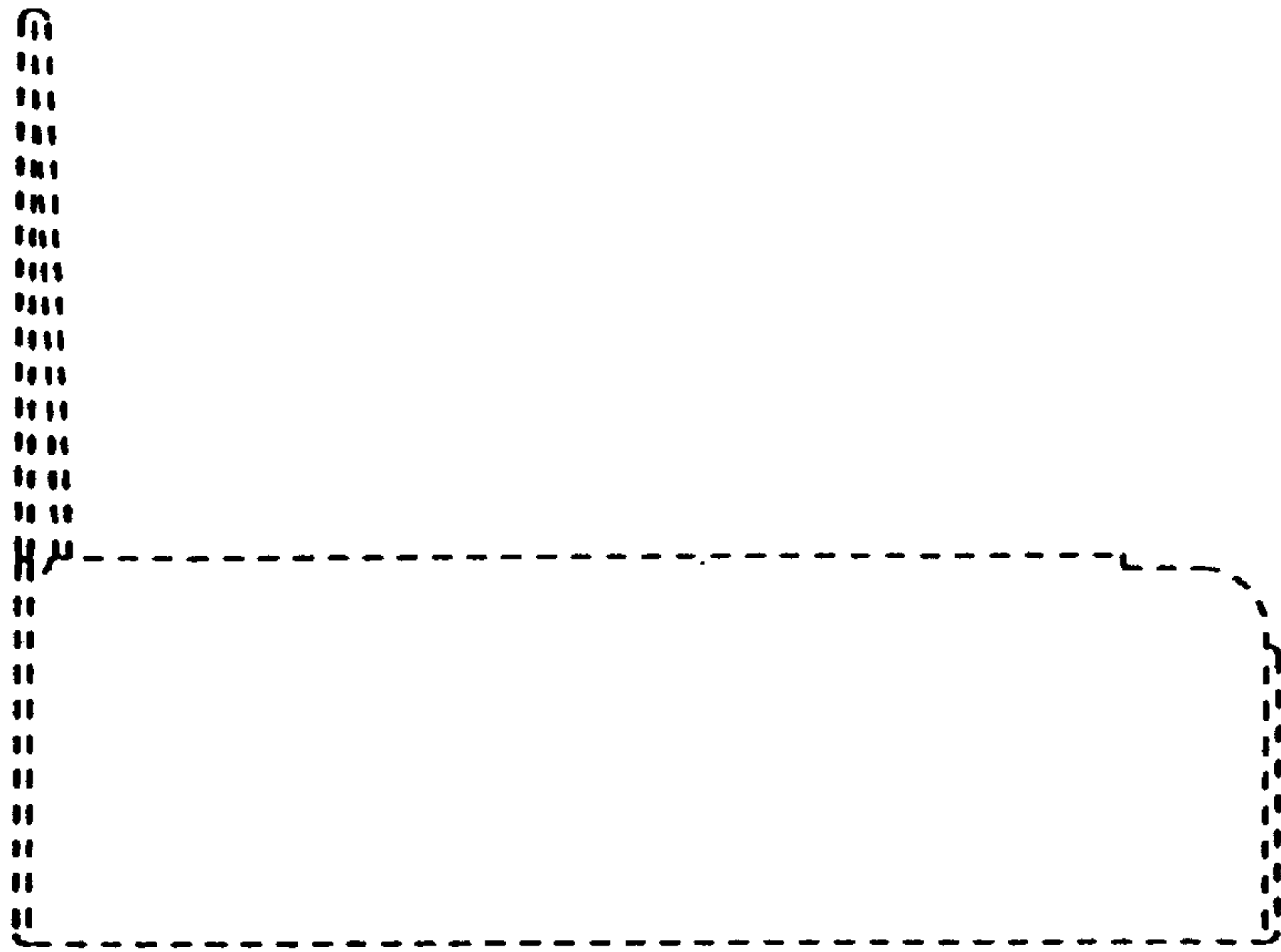

FIG. 6

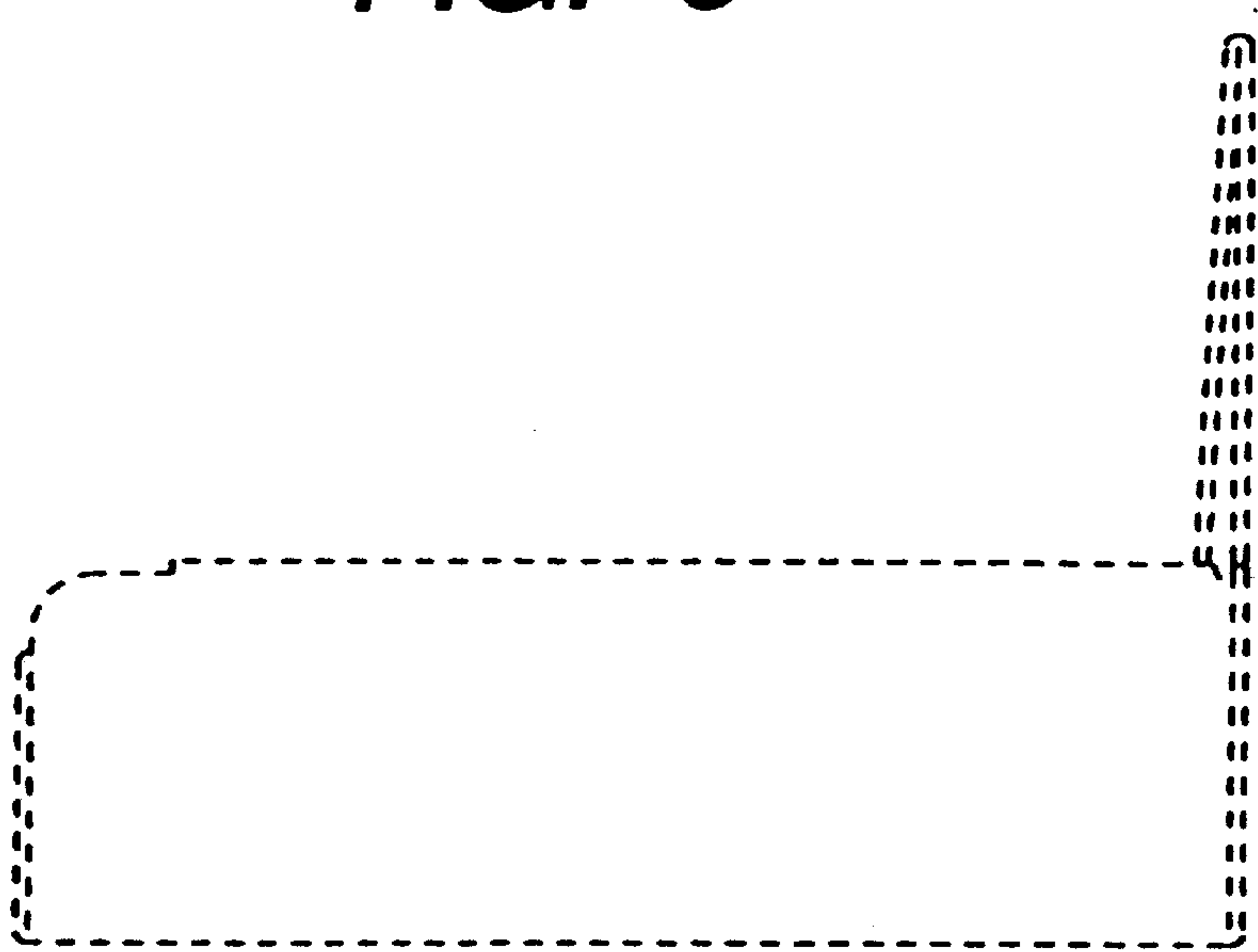

FIG. 7

