



US00D441583S

(12) **United States Design Patent**
Schmidt

(10) **Patent No.:** **US D441,583 S**

(45) **Date of Patent:** **** May 8, 2001**

(54) **SHELF DISPLAY**
(75) Inventor: **Mark T. Schmidt**, Madison, WI (US)
(73) Assignee: **Kraft Foods, Inc.**, Northfield, IL (US)
(**) Term: **14 Years**

1,908,928	5/1933	Stein .	
3,479,990	11/1969	Crow	19/1
3,863,575	2/1975	Kuns et al.	108/11
4,506,790	3/1985	Muscari	211/59.4
4,928,832	5/1990	Overmann	211/187
5,575,444	11/1996	Otema	248/22
5,871,108	2/1999	White	211/186

(21) Appl. No.: **29/116,926**
(22) Filed: **Jan. 12, 2000**

(51) **LOC (7) Cl.** **06-04**
(52) **U.S. Cl.** **D6/570; D6/553**
(58) **Field of Search** D6/396, 449, 477,
D6/479, 553, 567, 569, 570, 571; 108/28,
59, 64, 91, 92, 93, 150; 211/13.1, 71.01,
75, 86.01, 87.01, 88.01, 90.01, 126.1, 126.2,
128.1, 134, 153

* cited by examiner

Primary Examiner—Brian N. Vinson
(74) *Attorney, Agent, or Firm*—Fitch, Even, Tabin & Flannery

(57) **CLAIM**

The ornamental design for a shelf display, as shown and described.

DESCRIPTION

FIG. 1 is a perspective view of a shelf display according to the invention;
FIG. 2 is a front elevational view thereof;
FIG. 3 is a rear elevational view thereof;
FIG. 4 is a top plan view thereof;
FIG. 5 is a bottom plan view thereof;
FIG. 6 is a side elevational view from one side thereof; and,
FIG. 7 is a side elevational view from the other side thereof.
The broken-line disclosure of various elements in the views is for illustrative purposes only and forms no part of the claimed design.

(56) **References Cited**
U.S. PATENT DOCUMENTS

D. 85,980	1/1932	Foretich .	
D. 163,315	5/1951	Newton	D60/9
D. 180,617	7/1957	Patterson	D80/10
D. 194,727	2/1963	Amigone	D80/10
D. 249,301	9/1978	Ehrlich	D6/28
D. 250,301 *	11/1978	Handler et al.	D6/449
D. 264,278	5/1982	Wainer	D6/28
D. 284,052	6/1986	Blunden	D6/457
D. 411,697	6/1999	Hannecke	D6/46
1,560,122	11/1925	Vance .	
1,824,813	9/1931	Friedemann .	

1 Claim, 5 Drawing Sheets

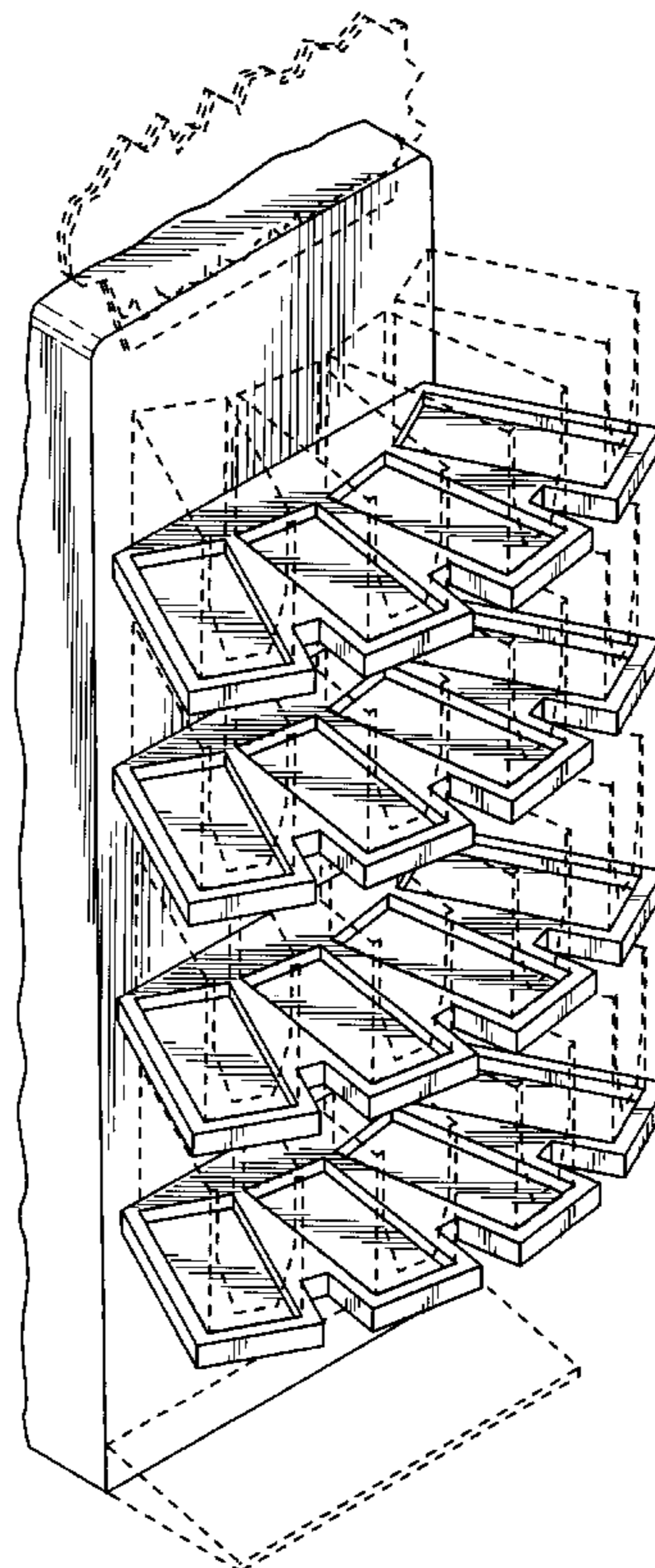

Fig. 1

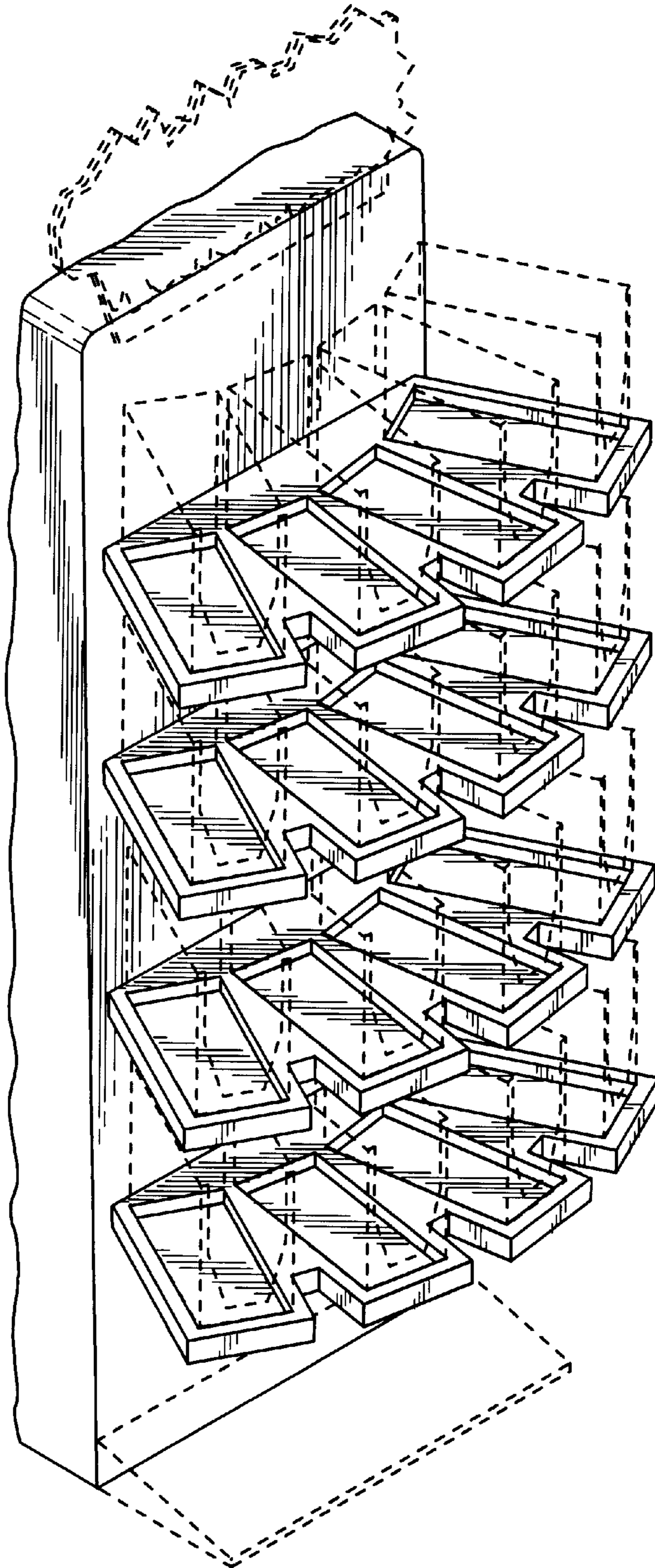

Fig. 2

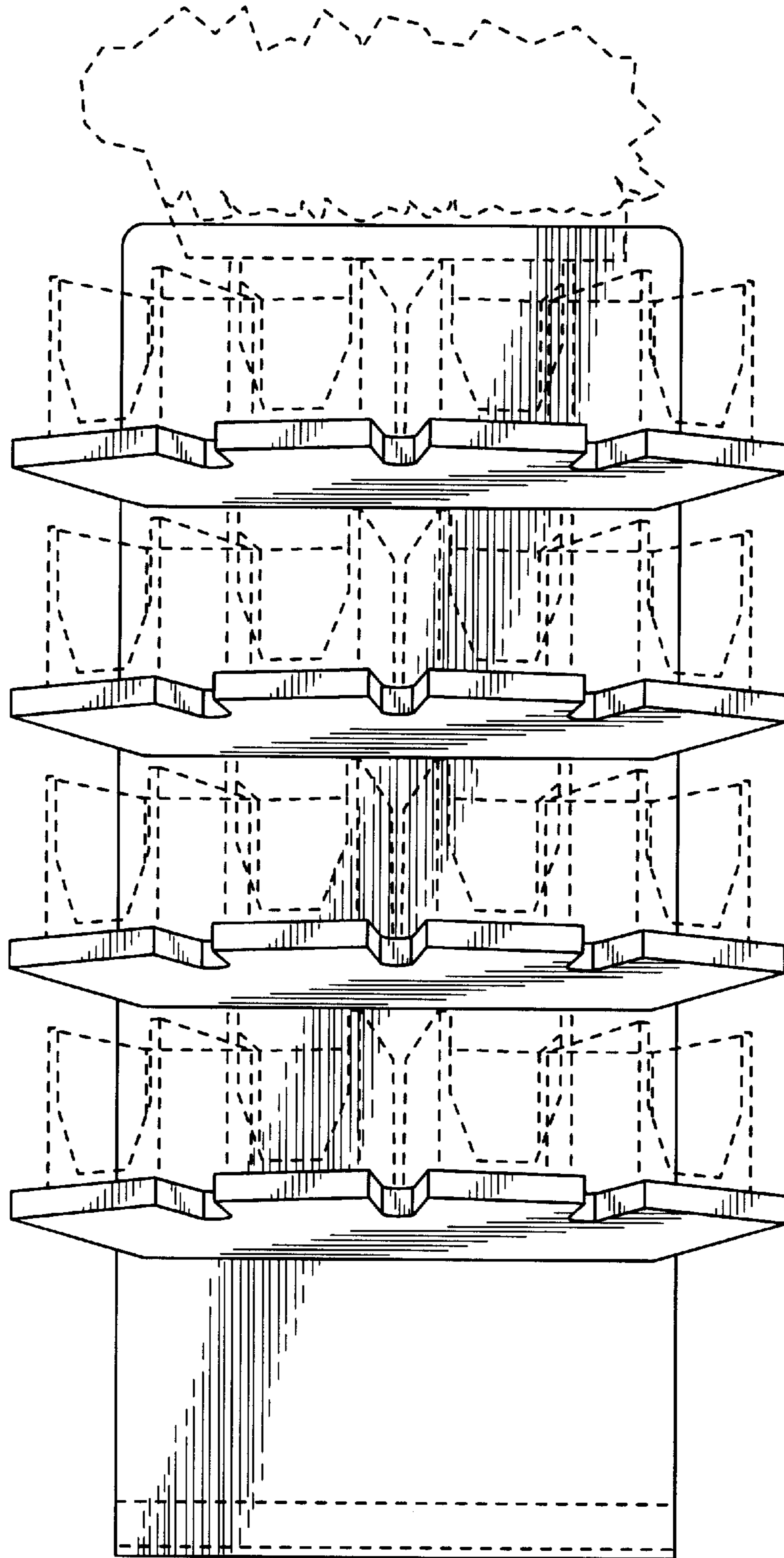

Fig. 3

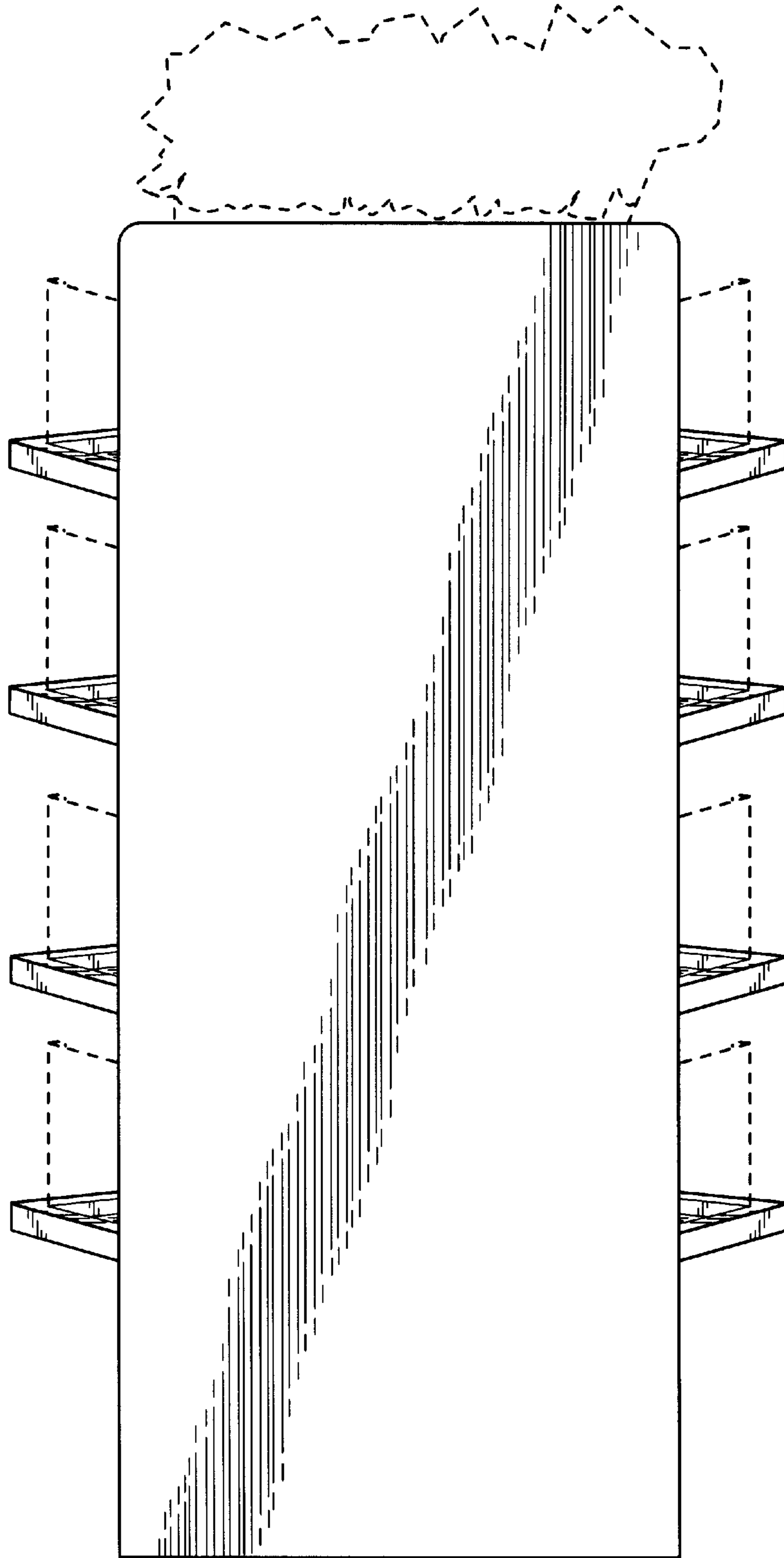

Fig. 4

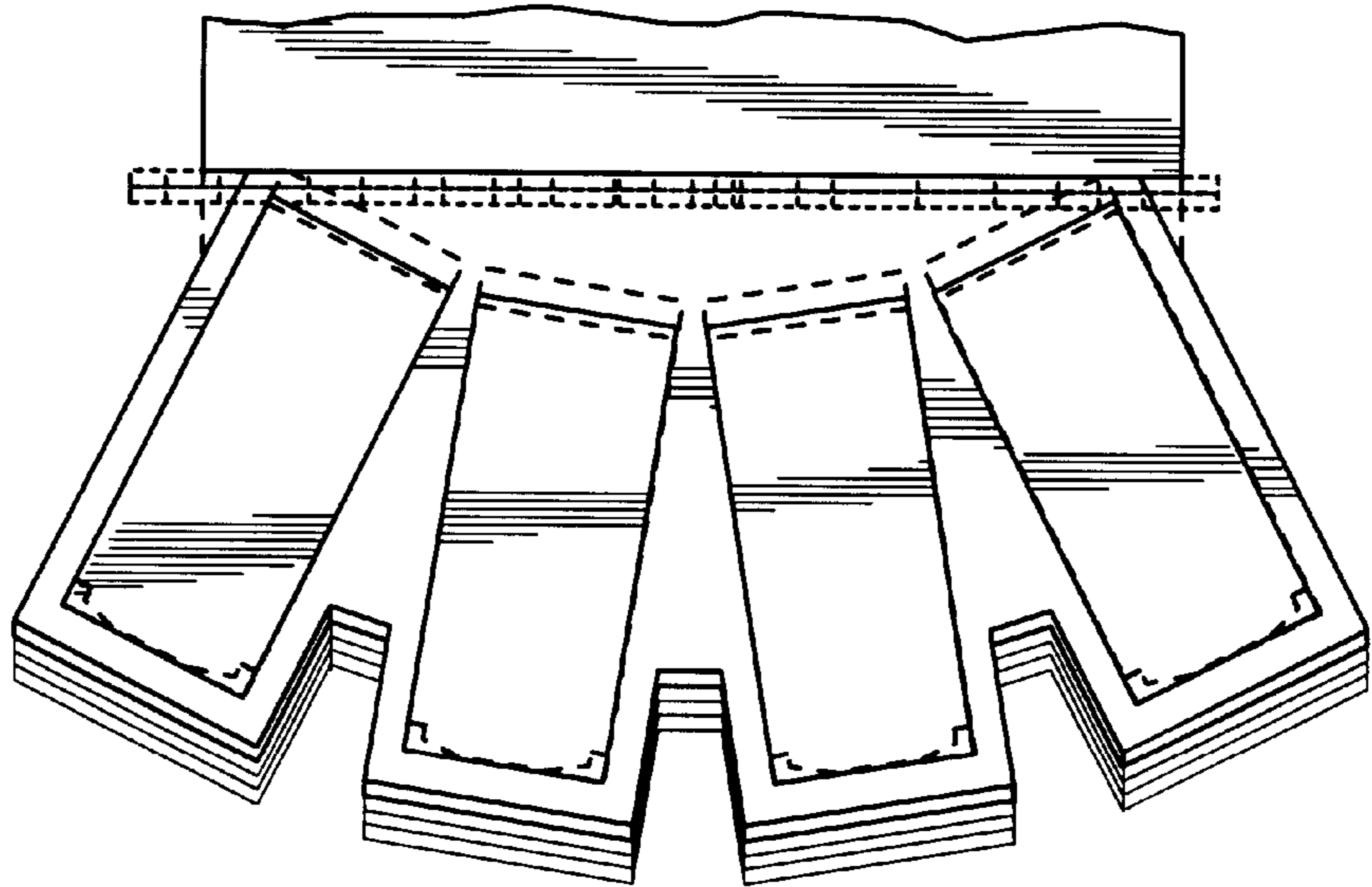

Fig. 5

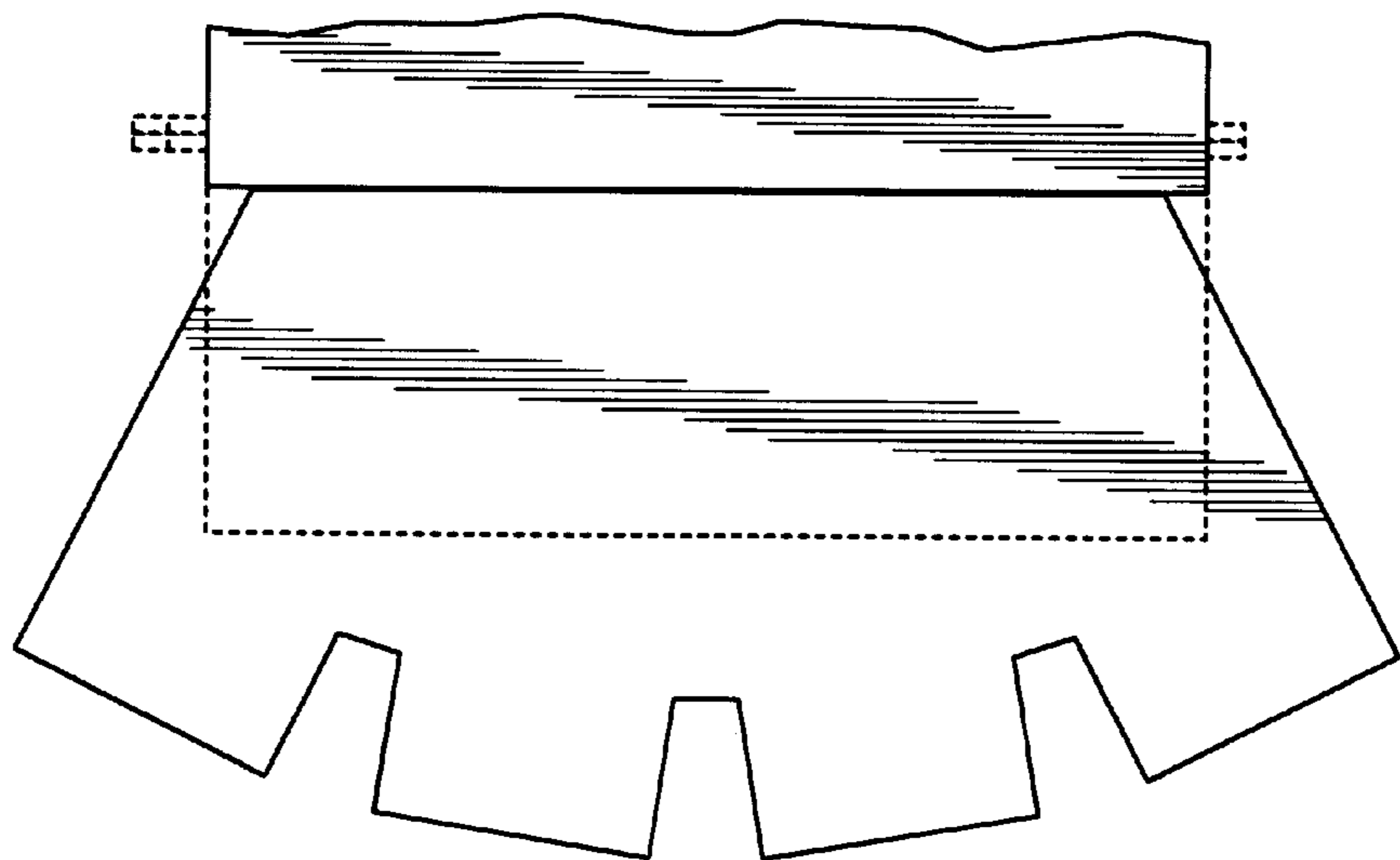

Fig. 6

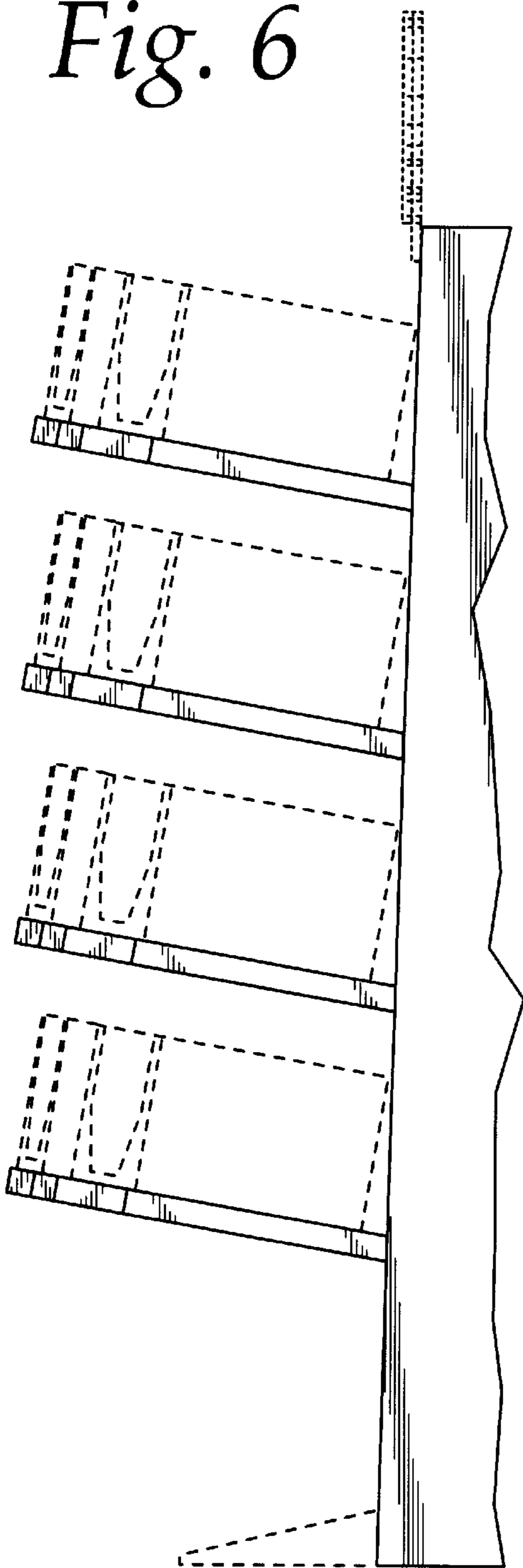

Fig. 7

