



US00D441576S

(12) **United States Design Patent**
Foster

(10) **Patent No.:** **US D441,576 S**

(45) **Date of Patent:** **** May 8, 2001**

(54) **HANDLE FOR CABINET SIDE PANEL**

(75) Inventor: **Simon Foster**, Fair Oak (GB)

(73) Assignee: **APW Electronics Limited**, Hants (GB)

(**) Term: **14 Years**

(21) Appl. No.: **29/120,674**

(22) Filed: **Mar. 24, 2000**

(30) **Foreign Application Priority Data**

Sep. 28, 1999 (GB) 2086997

(51) **LOC (7) Cl.** **06-06**

(52) **U.S. Cl.** **D6/509; D6/492**

(58) **Field of Search** D6/491, 492, 509,
D6/510, 511, 445, 446, 447, 448, 432;
D13/162, 163, 164, 184; D14/240; D8/313;
312/223.1, 223.2, 223.3

(56) **References Cited**

U.S. PATENT DOCUMENTS

- D. 357,371 * 4/1995 Keller D6/446
- D. 365,703 * 1/1996 Miller et al. D6/446
- D. 391,137 * 2/1998 Moebius D8/313
- D. 402,529 * 12/1998 Husted D8/313

- D. 417,350 * 12/1999 Zaidman D6/510
- D. 418,959 * 1/2000 Tisbo et al. D6/445 X
- D. 419,802 * 2/2000 Carville et al. D6/509
- D. 431,995 * 10/2000 West D8/313

* cited by examiner

Primary Examiner—Cathron Brooks

(74) *Attorney, Agent, or Firm*—Harter, Secrest & Emery LLP; Stephen B. Salai, Esq.; Brian B. Shaw, Esq.

(57) **CLAIM**

The ornamental design for a handle for cabinet side panel, as shown and described.

DESCRIPTION

FIG. 1 is a bottom front perspective view showing my new design;
 FIG. 2 is a bottom rear perspective view thereof;
 FIG. 3 is a front elevation thereof;
 FIG. 4 is a rear elevation thereof;
 FIG. 5 is a left side view thereof;
 FIG. 6 is a right side view thereof;
 FIG. 7 is a top plan view thereof; and,
 FIG. 8 is a cross sectional view on line 8—8 of FIG. 3.
 The broken lines shown in the drawings are for illustrative purposes only and form no part of the claimed design.

1 Claim, 2 Drawing Sheets

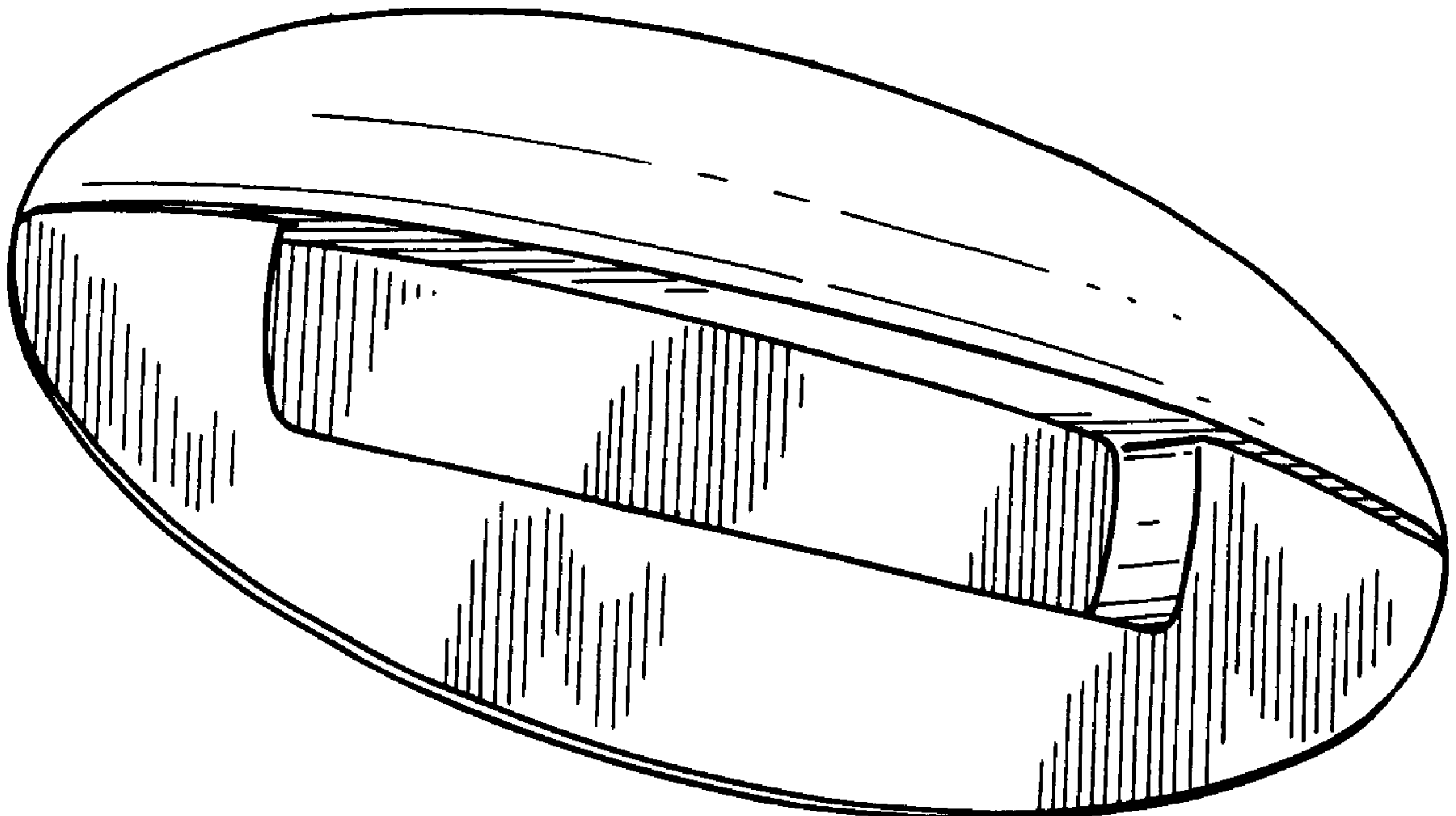

FIG. 1

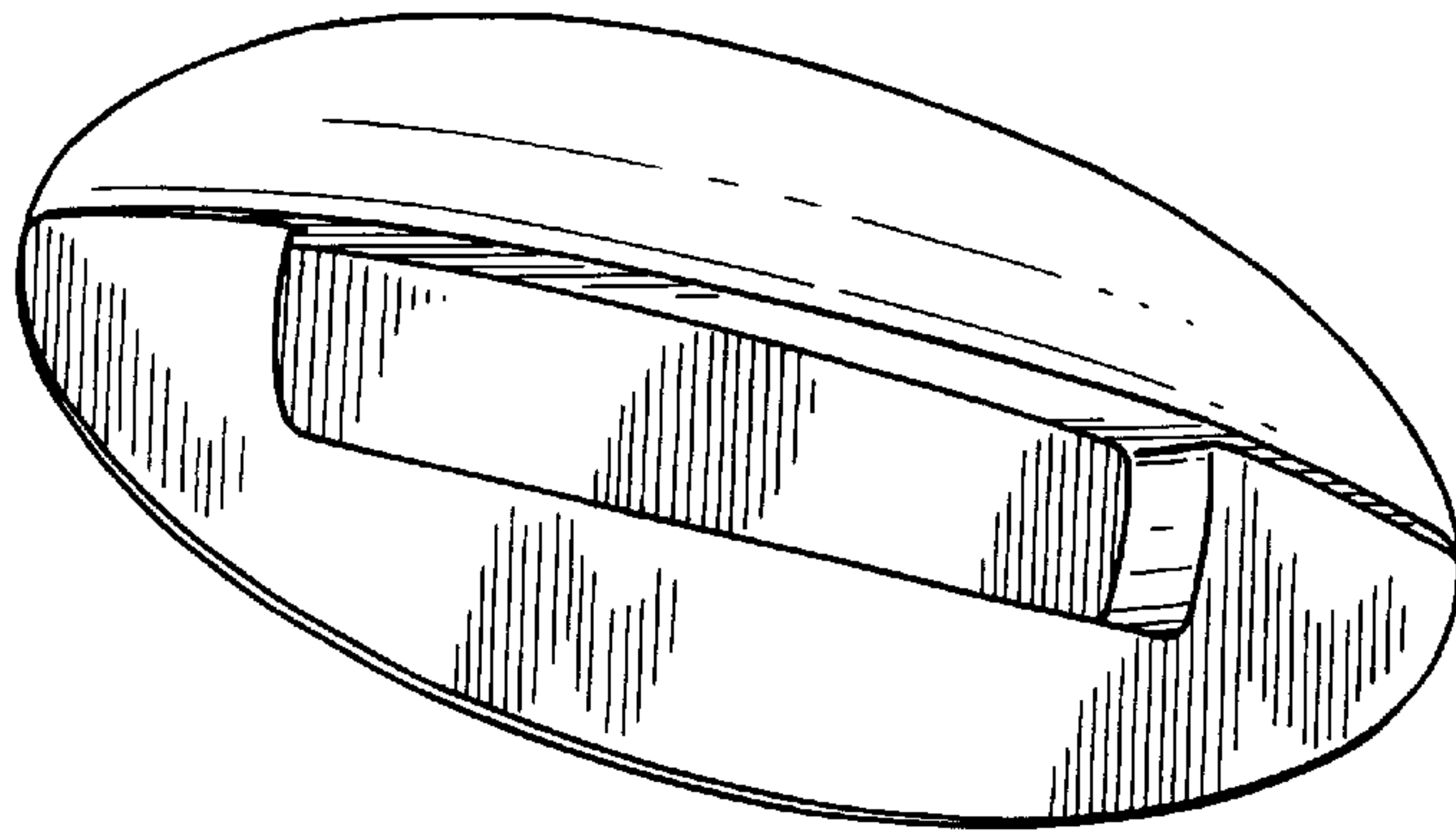

FIG. 2

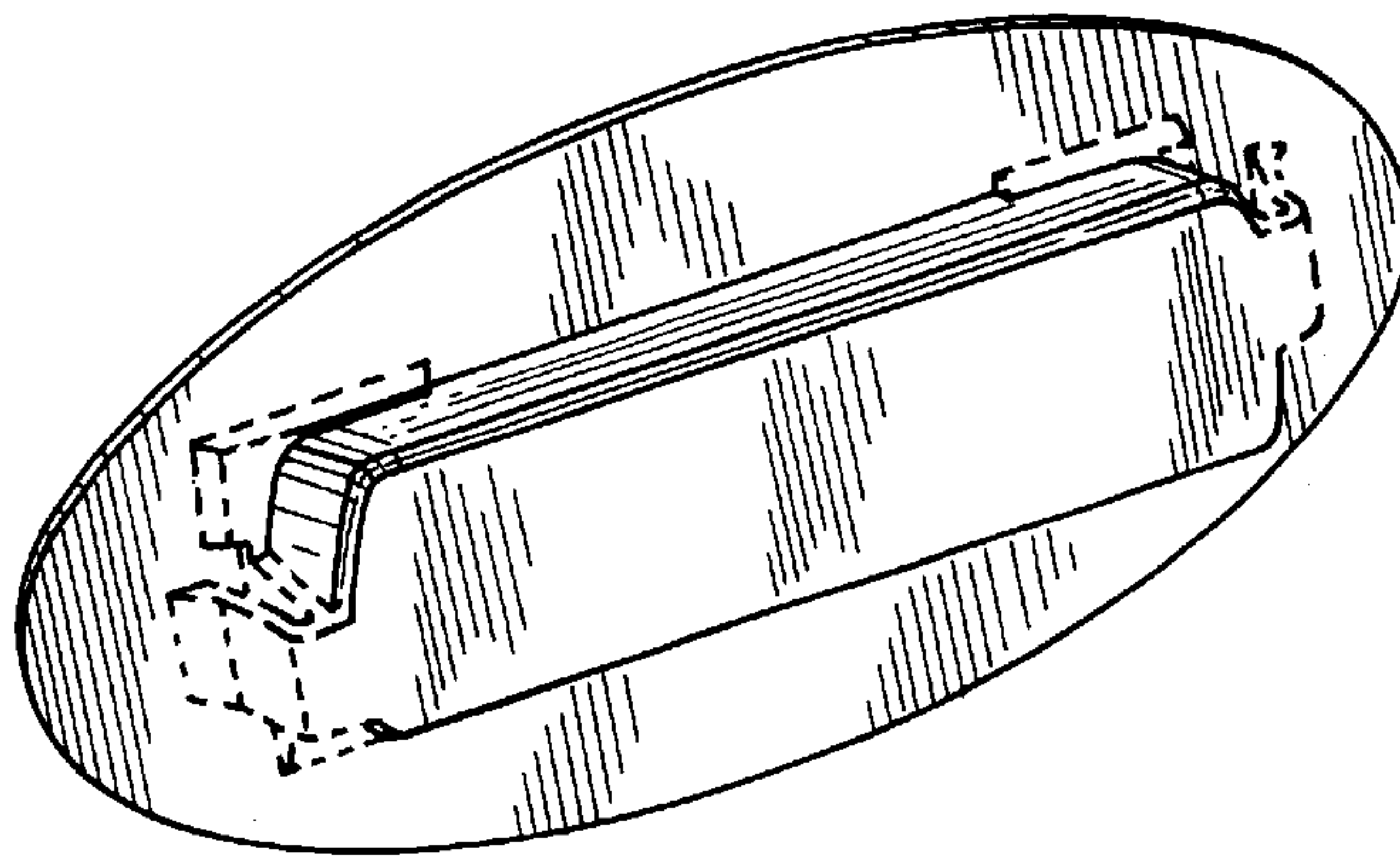

FIG. 3

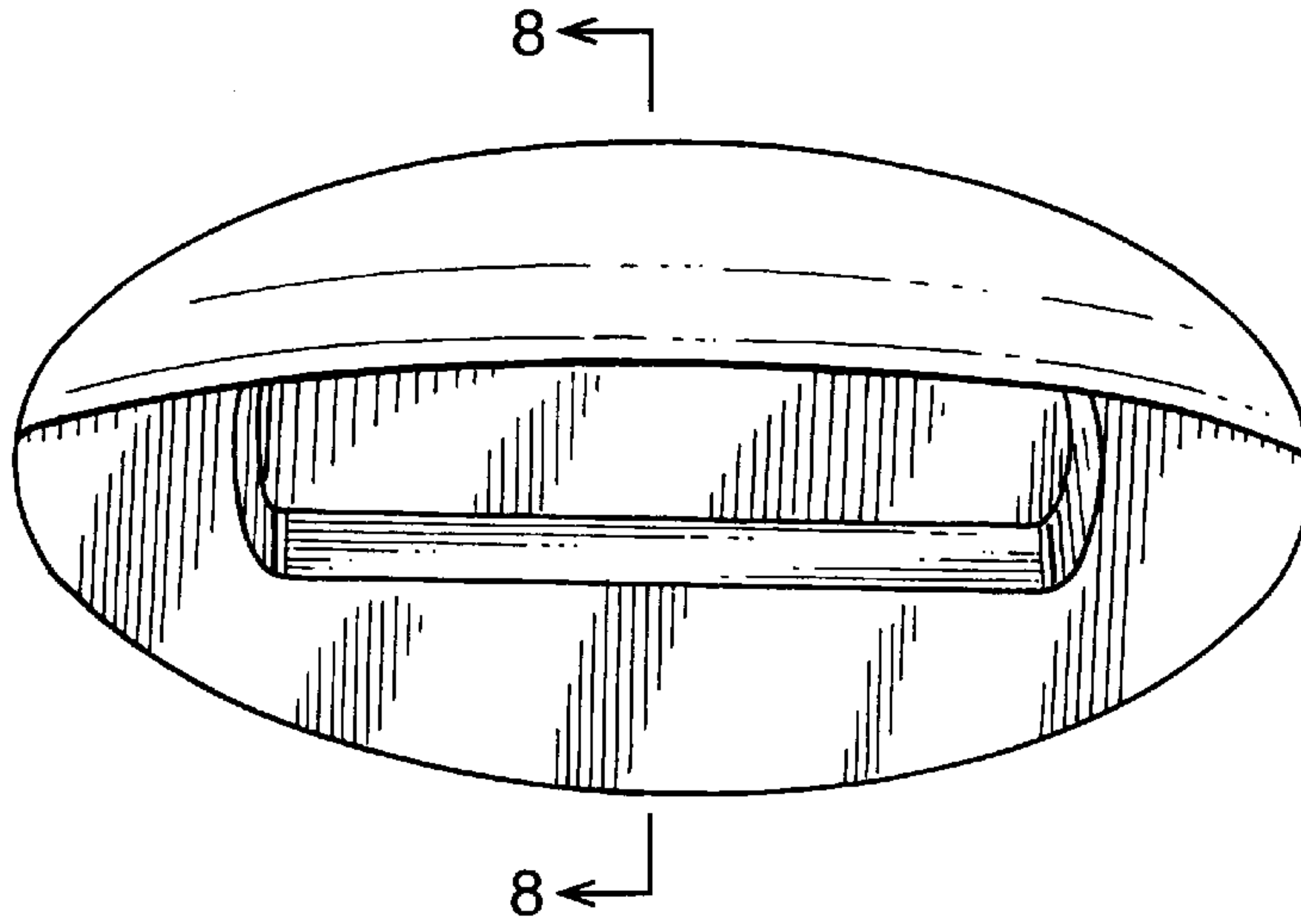

FIG. 8

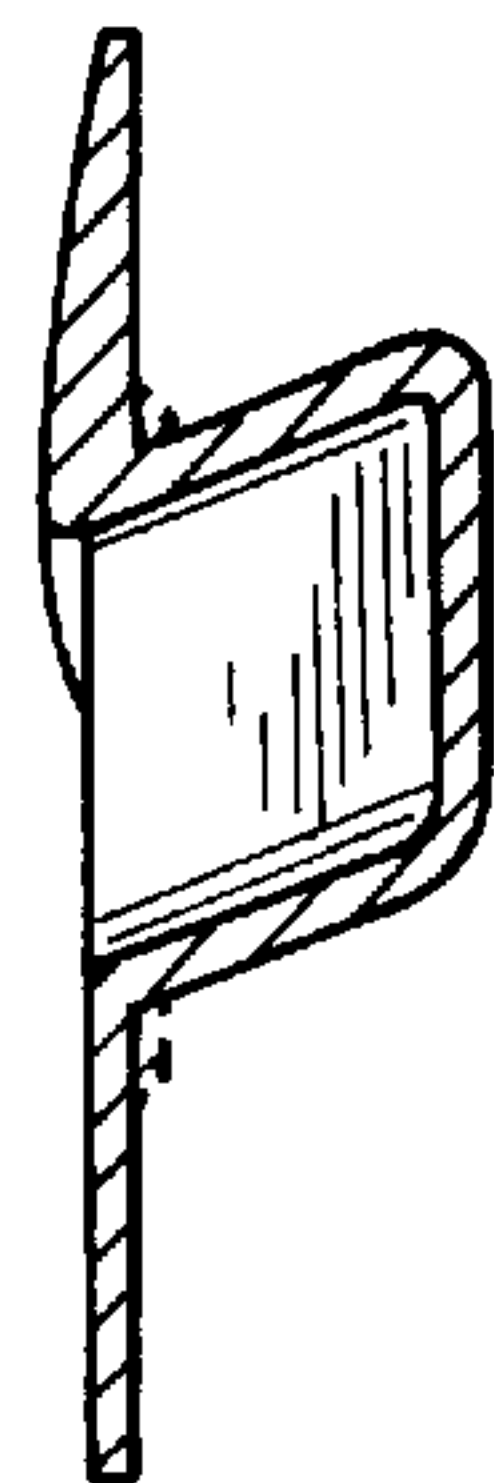

FIG. 4

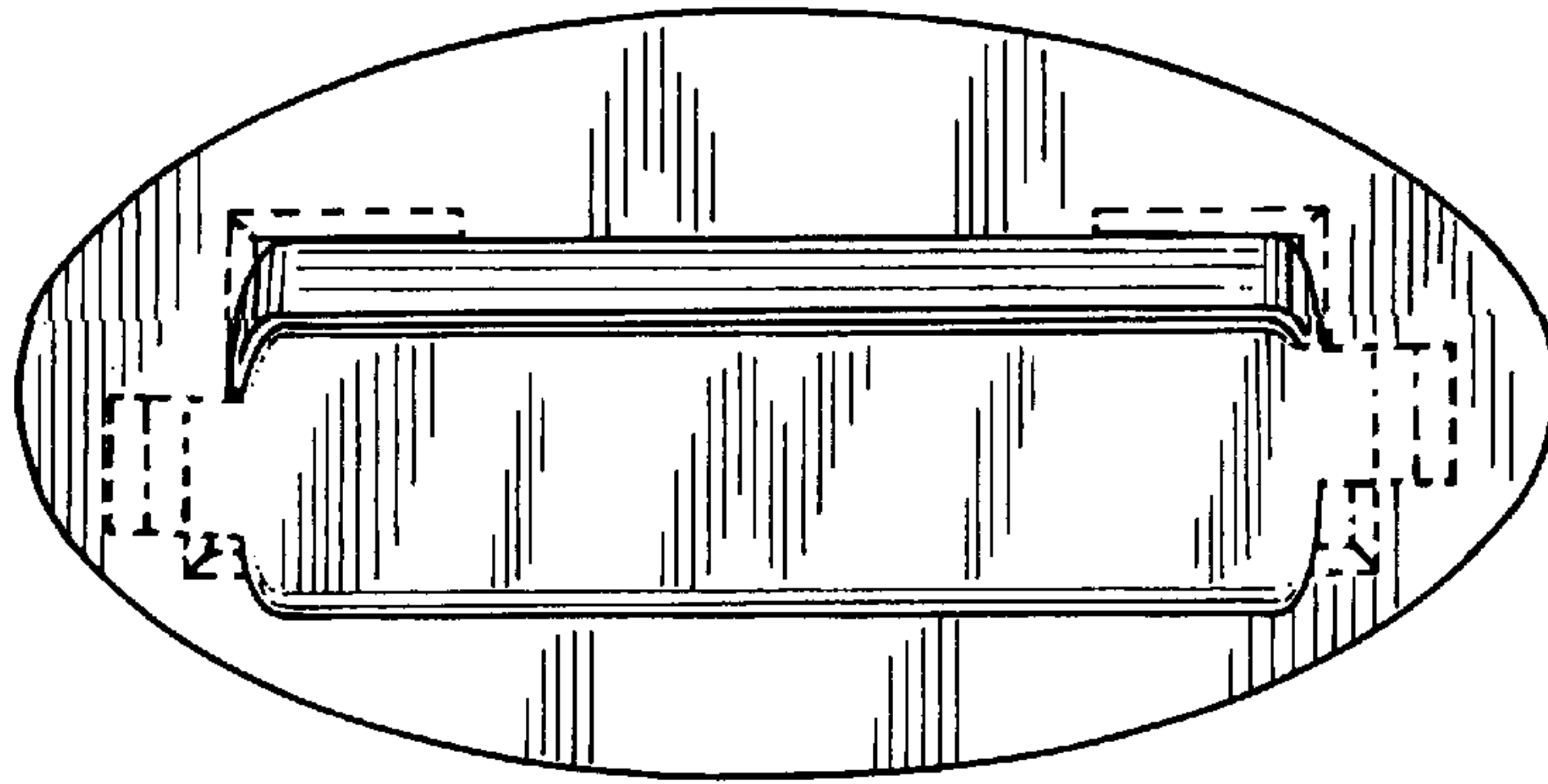

FIG. 5

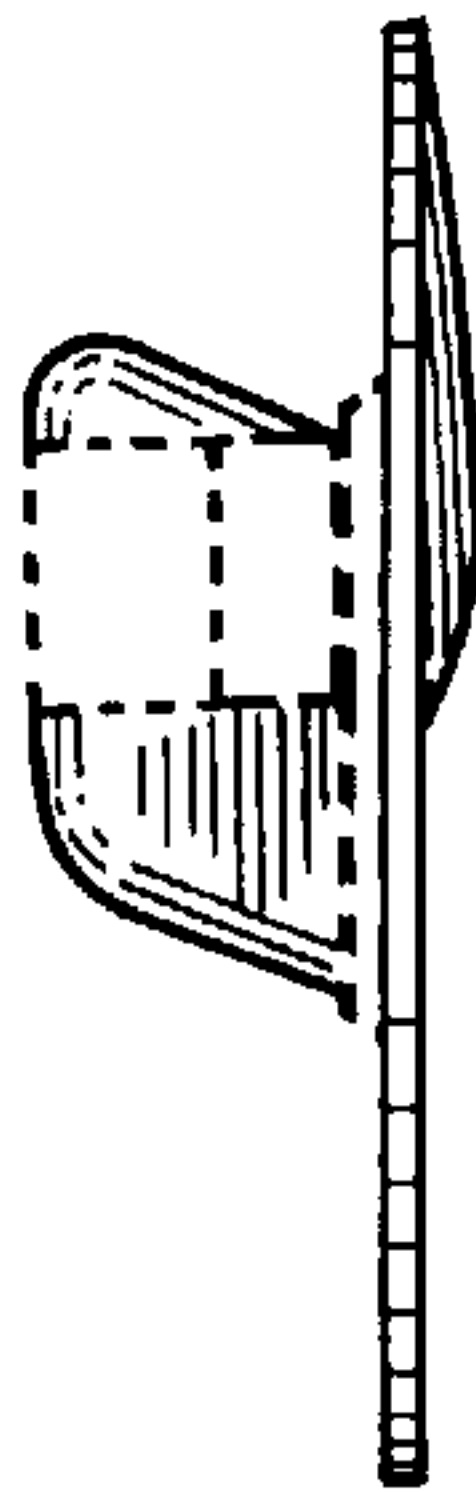

FIG. 6



FIG. 7

