



US00D441552S

(12) **United States Design Patent**
McCarthy

(10) **Patent No.:** **US D441,552 S**

(45) **Date of Patent:** **** May 8, 2001**

(54) **SEAT**

(76) **Inventor:** **Richard McCarthy**, 939 Burke St.,
Winston-Salem, NC (US) 27101

(**) **Term:** **14 Years**

(21) **Appl. No.:** **29/132,547**

(22) **Filed:** **Nov. 9, 2000**

(51) **LOC (7) Cl.** **06-01**

(52) **U.S. Cl.** **D6/334; D6/381**

(58) **Field of Search** D6/334, 335, 336,
D6/364, 371, 381, 500, 501, 502; 5/12.1;
297/232, 445.1

(56) **References Cited**

U.S. PATENT DOCUMENTS

D. 369,480	*	5/1996	Natuzzi et al.	D6/381
D. 369,694	*	5/1996	Natuzzi et al.	D6/381
D. 374,355	*	10/1996	Natuzzi et al.	D6/381
D. 380,103	*	6/1997	Natuzzi et al.	D6/381

D. 384,219 * 9/1997 Natuzzi et al. D6/381

D. 385,426 * 10/1997 Gibson D6/381

D. 400,368 * 11/1998 Natuzzi et al. D6/381

* cited by examiner

Primary Examiner—Cary D. Watson

(57) **CLAIM**

I claim the ornamental design for a seat, as shown.

DESCRIPTION

FIG. 1 is a perspective view of a first embodiment of a seat showing my new design in the form of a chair;

FIG. 2 is a perspective view of a second embodiment of a seat in the form of a love seat;

FIG. 3 is a perspective view of a third embodiment of a seat in the form of a sofa;

FIG. 4 is a top plan view thereof;

FIG. 5 is a front elevational view thereof;

FIG. 6 is a left side elevational view thereof; and,

FIG. 7 is a right side elevational view thereof.

1 Claim, 3 Drawing Sheets

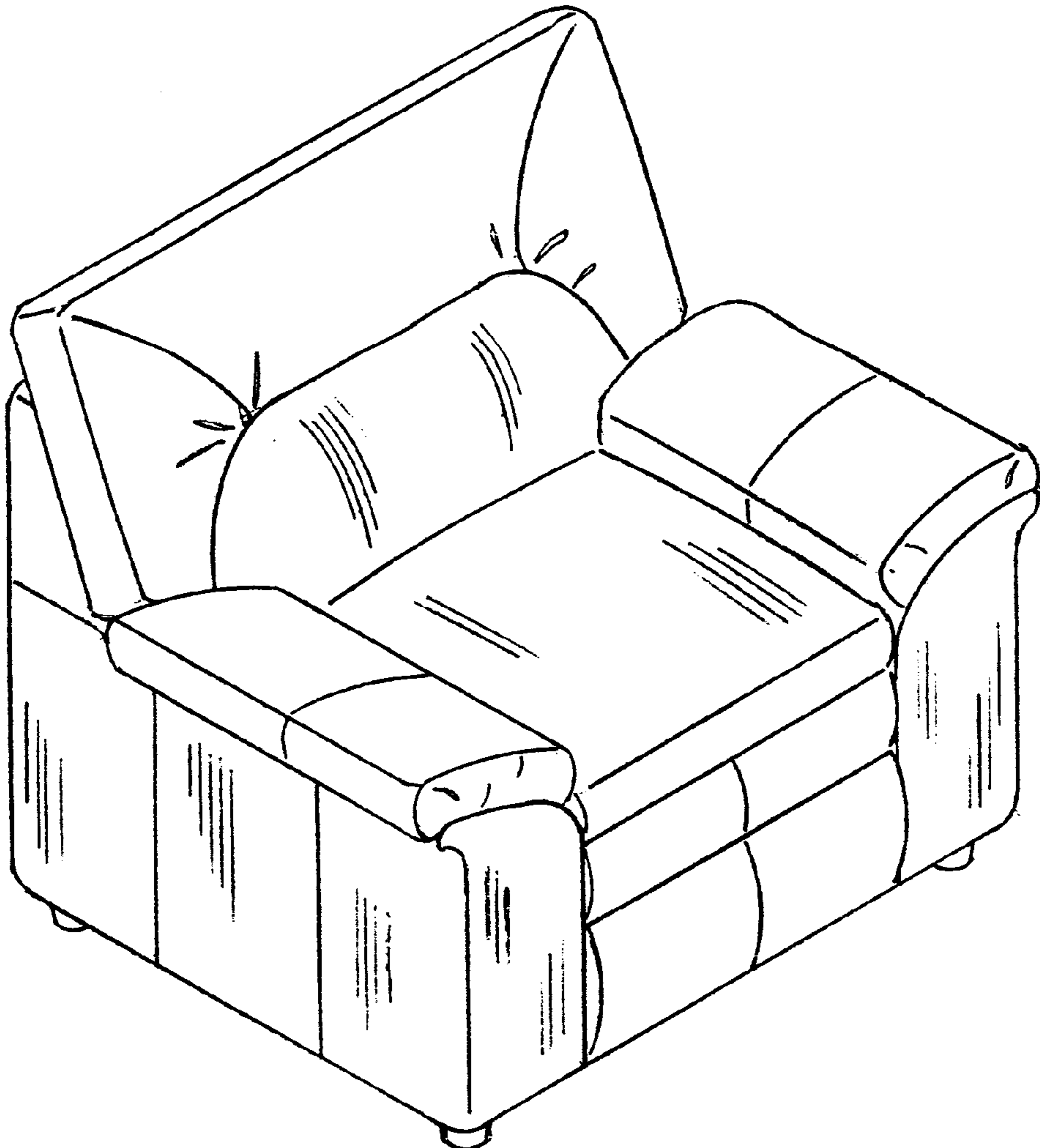

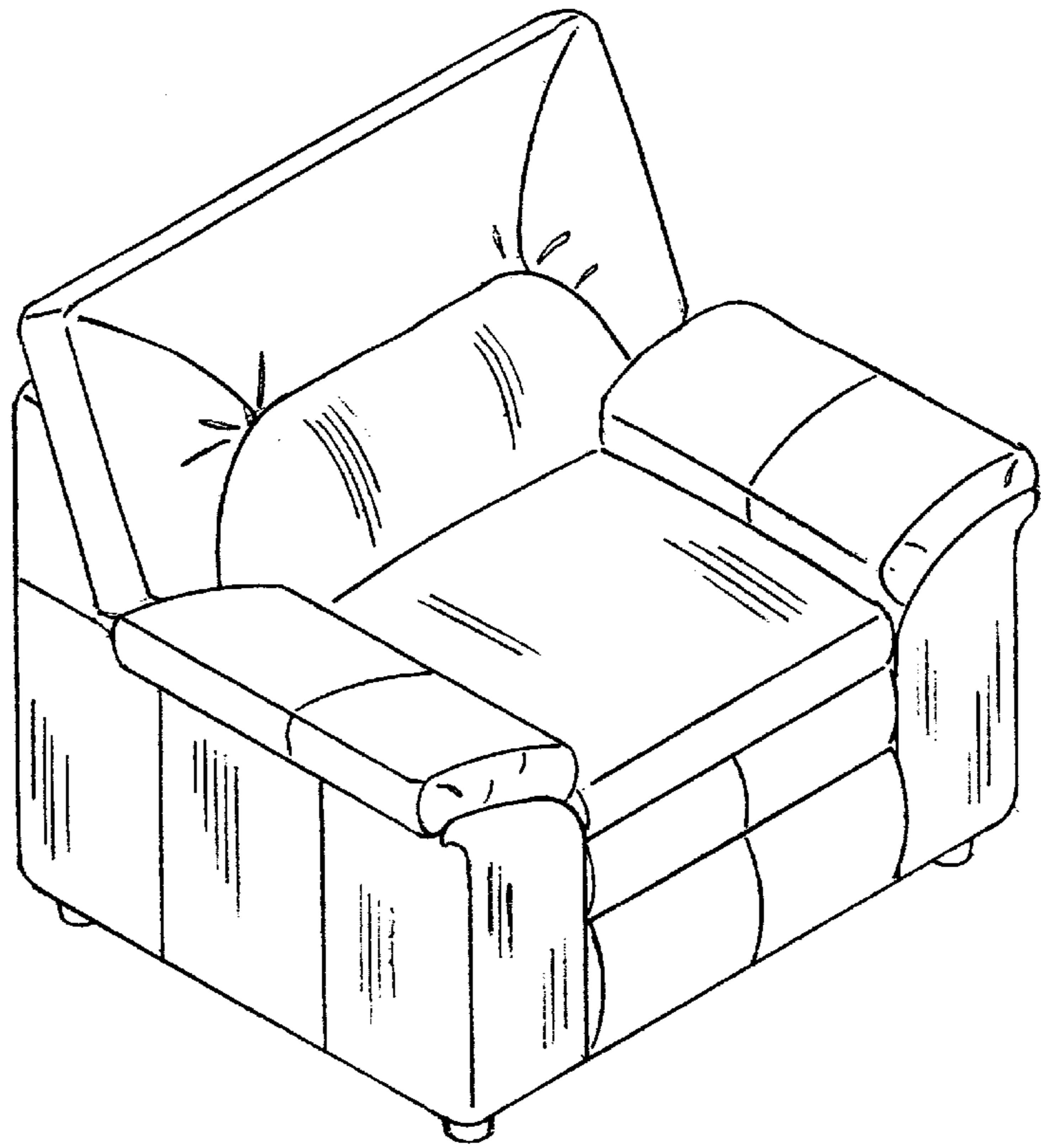

FIG. 1

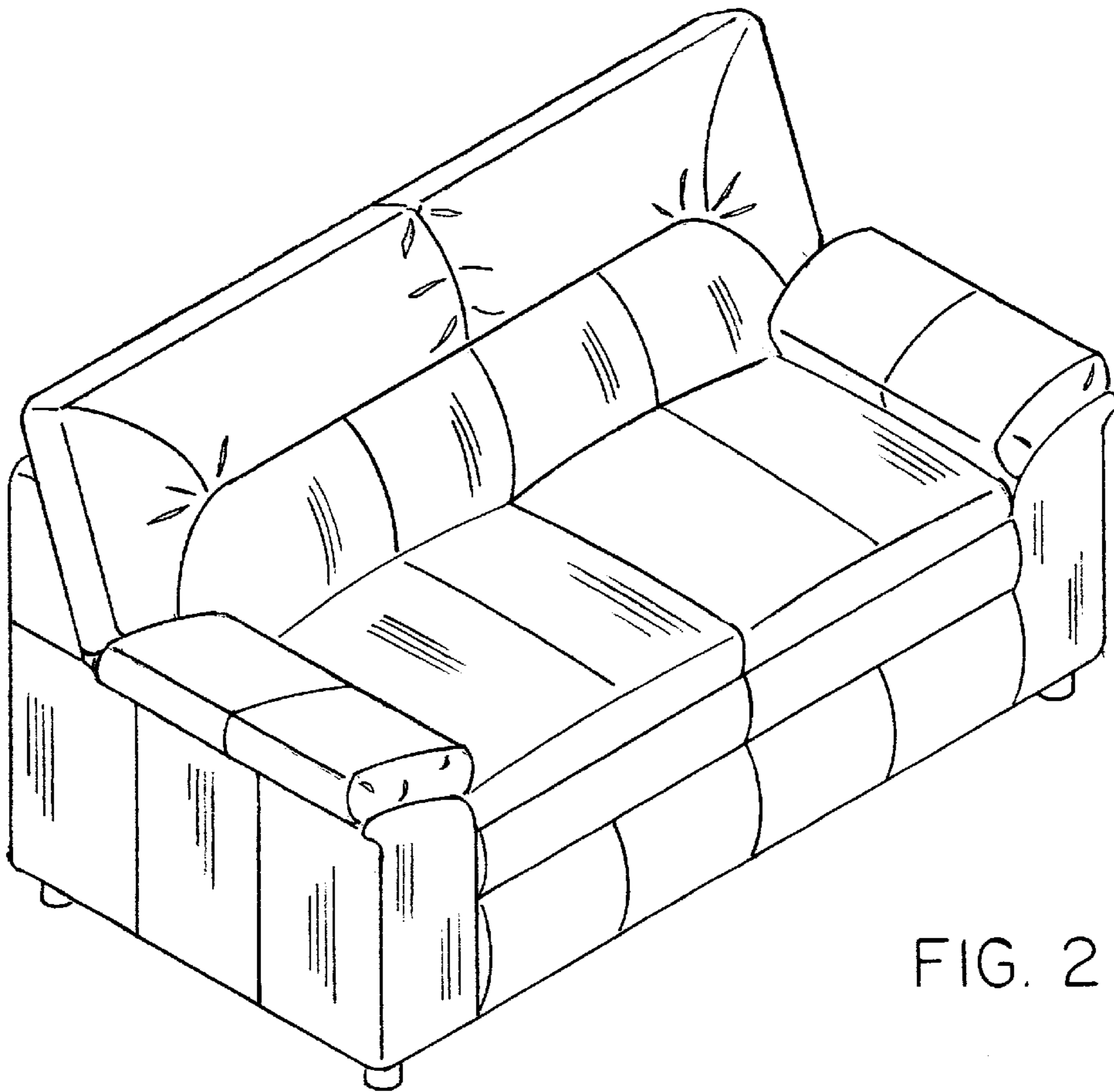

FIG. 2

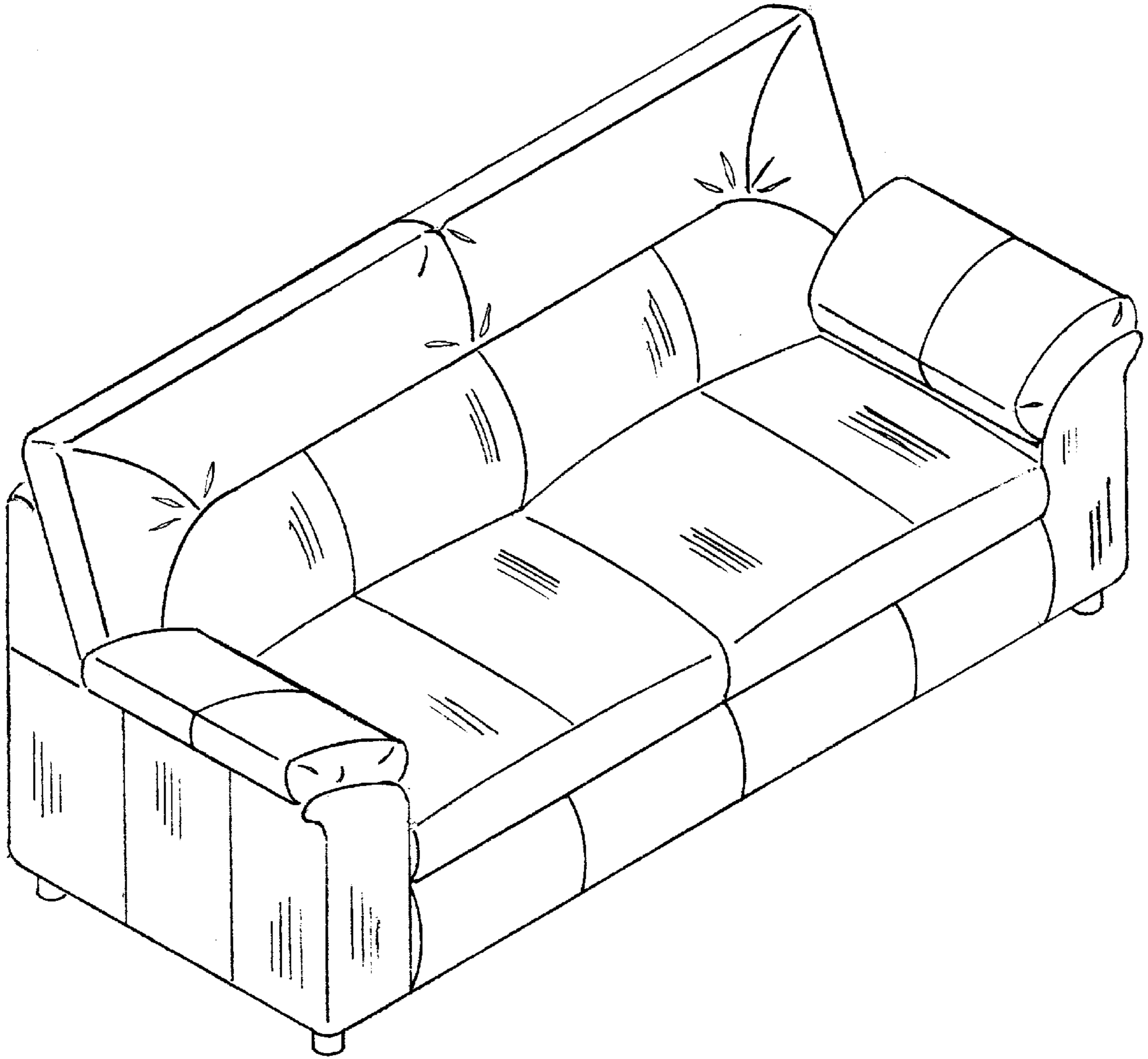

FIG. 3

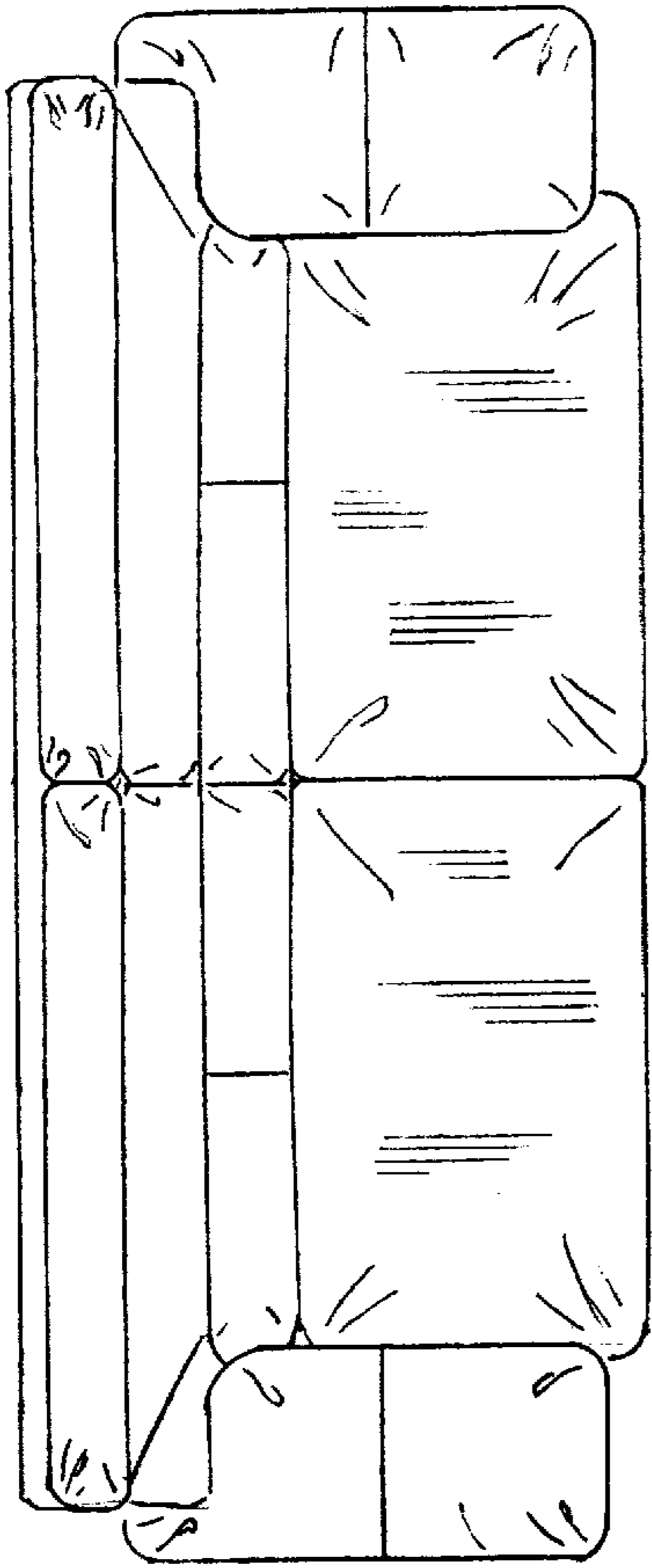

FIG. 4

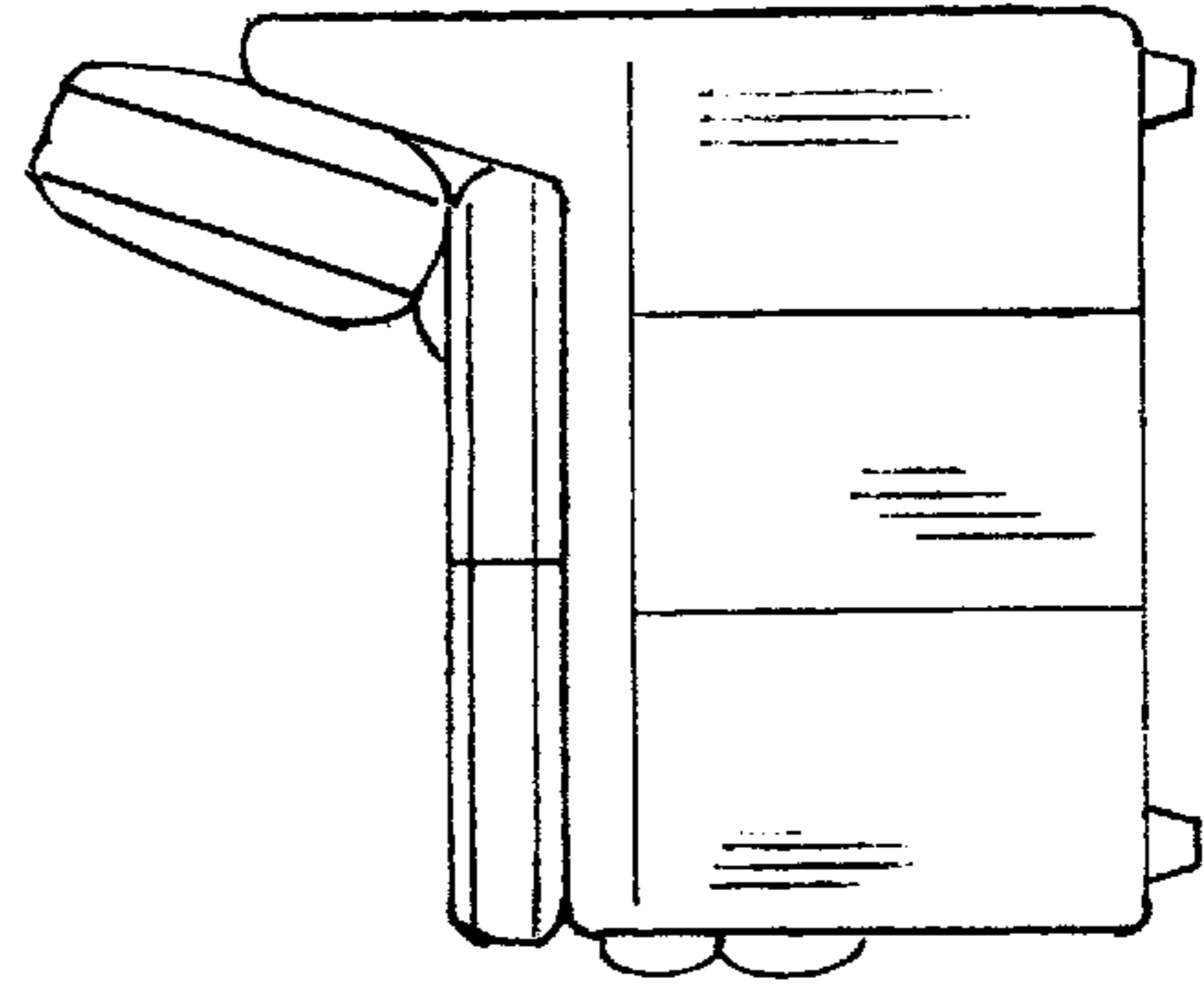

FIG. 7

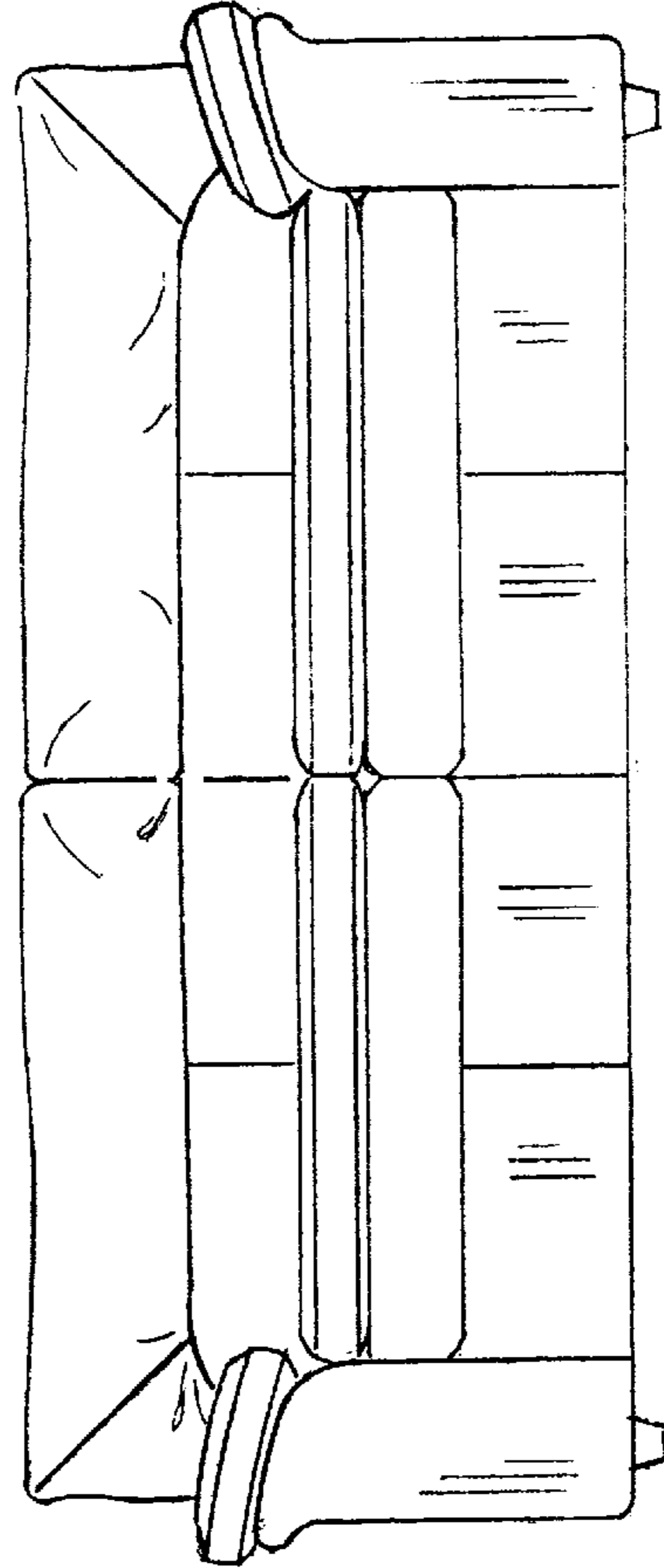

FIG. 5

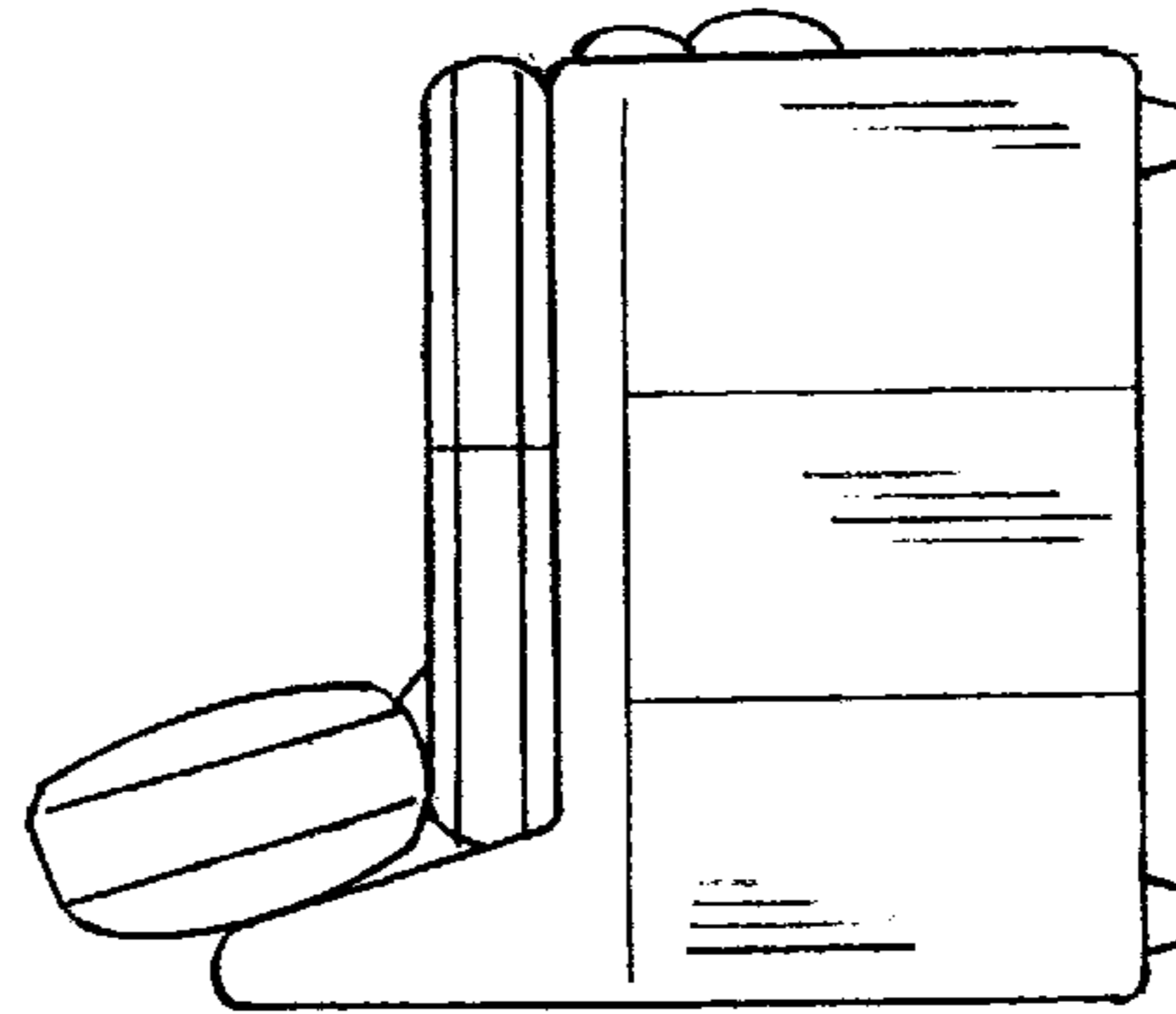

FIG. 6