



US00D441497S

(12) **United States Design Patent** (10) **Patent No.:** **US D441,497 S**  
**Focke et al.** (45) **Date of Patent:** **\*\* May 1, 2001**

(54) **CIGARETTE PACK**

(75) Inventors: **Heinz Focke**, Verden; **Henry Buse**, Visselhövede, both of (DE)

(73) Assignee: **Focke & Co. (GmbH & Co.)**, Verden (DE)

(\*\*) Term: **14 Years**

(21) Appl. No.: **29/119,888**

(22) Filed: **Mar. 9, 2000**

(30) **Foreign Application Priority Data**

Nov. 10, 1999 (XH) ..... DM/050 206

(51) **LOC (7) Cl.** ..... **27-06**

(52) **U.S. Cl.** ..... **D27/189**

(58) **Field of Search** ..... D27/172, 183, 206/242, 265, 259, 268, 271, 273

(56) **References Cited**

**U.S. PATENT DOCUMENTS**

D. 421,151	*	2/2000	Luton et al.	.....	D27/189
5,487,468	*	1/1996	Sheahan	.....	206/242
5,715,936	*	2/1998	Focke et al.	.....	206/268
5,823,331	*	10/1998	Manservigi	.....	206/268
5,845,770	*	12/1998	James et al.	.....	206/268
5,896,984	*	4/1999	Focke et al.	.....	206/268
5,921,384	*	7/1999	Focke et al.	.....	206/268

\* cited by examiner

*Primary Examiner*—Susan J. Lucas

*Assistant Examiner*—Jennifer Rivard

(74) *Attorney, Agent, or Firm*—Abelman, Frayne & Schwab

(57) **CLAIM**

The ornamental design for cigarette pack, as shown and described.

**DESCRIPTION**

FIG. 1 is a perspective view showing the new cigarette pack design, with the lid in the open position;

FIG. 2 is a right side view thereof, with the lid closed;

FIG. 3 is a front view thereof, with the lid closed;

FIG. 4 is a left-side view thereof, with the lid closed;

FIG. 5 is a bottom view thereof, with the top view being a mirror image thereof;

FIG. 6 is a rear view thereof, with the lid closed.

FIG. 7 is a perspective view showing the second embodiment of the new cigarette pack design, with the lid in the open position;

FIG. 8 is a right side view thereof, with the lid closed;

FIG. 9 is a front view thereof, with the lid closed;

FIG. 10 is a left-side view thereof, with the lid closed;

FIG. 11 is a bottom view thereof, with the top view being a mirror image thereof;

FIG. 12 is a rear view thereof, with the lid closed.

FIG. 13 is a perspective view showing the third embodiment of the new cigarette pack design, with the lid in the open position;

FIG. 14 is a right side view thereof, with the lid closed;

FIG. 15 is a front view thereof, with the lid closed;

FIG. 16 is a left-side view thereof, with the lid closed;

FIG. 17 is a bottom view thereof, with the top view being a mirror image thereof; and,

FIG. 18 is a rear view thereof, with the lid closed.

**1 Claim, 3 Drawing Sheets**

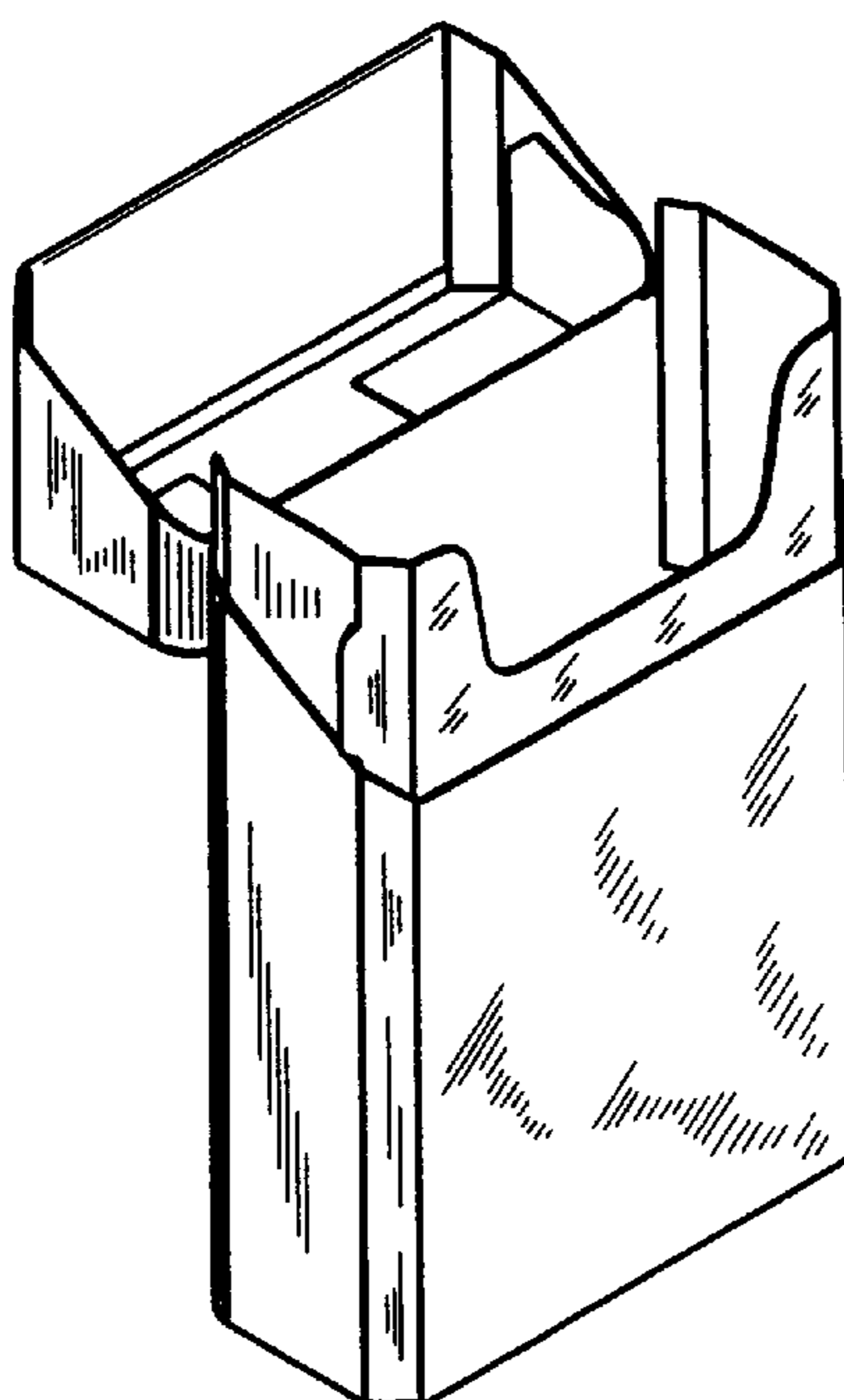

Fig. 1

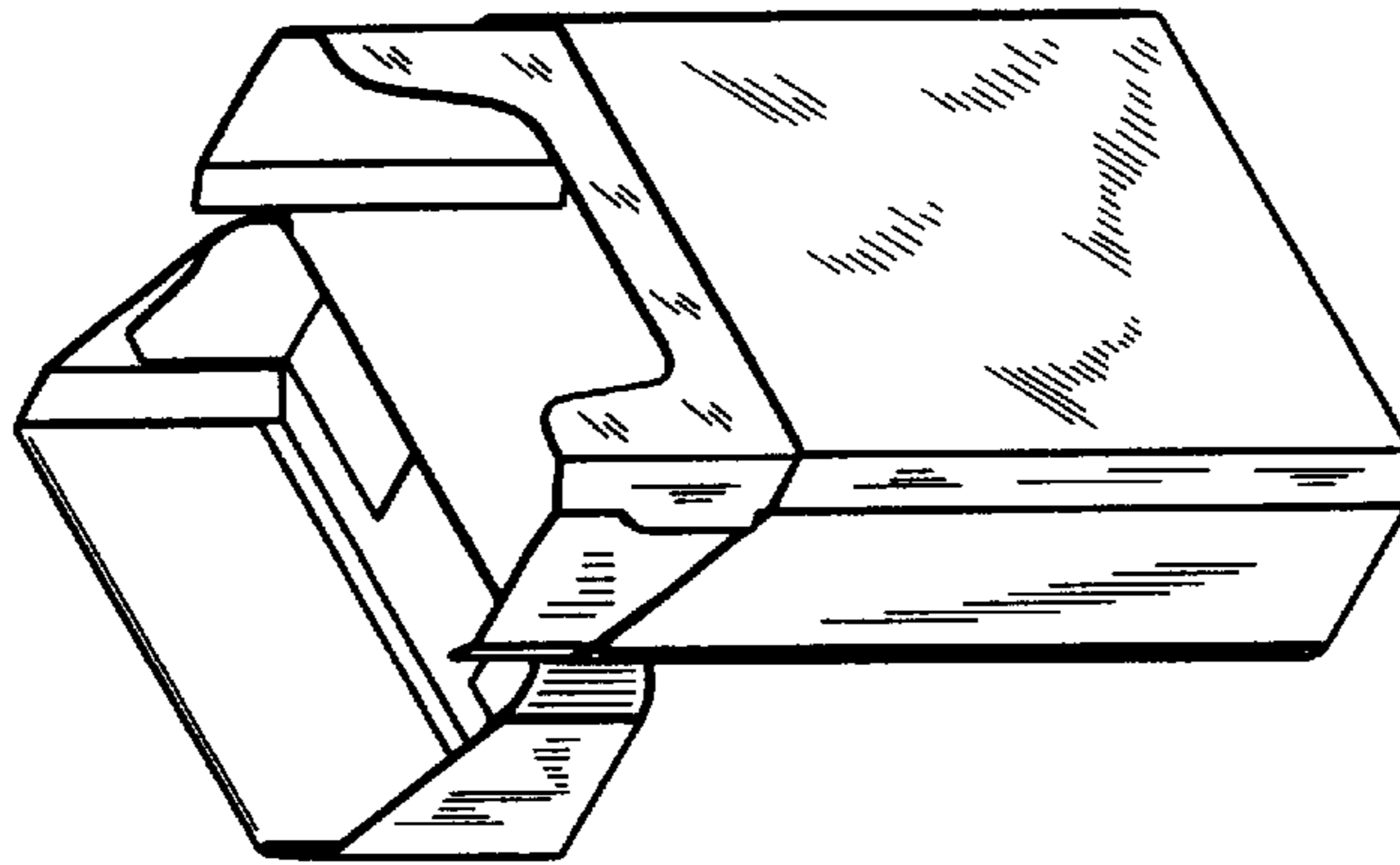

Fig. 2

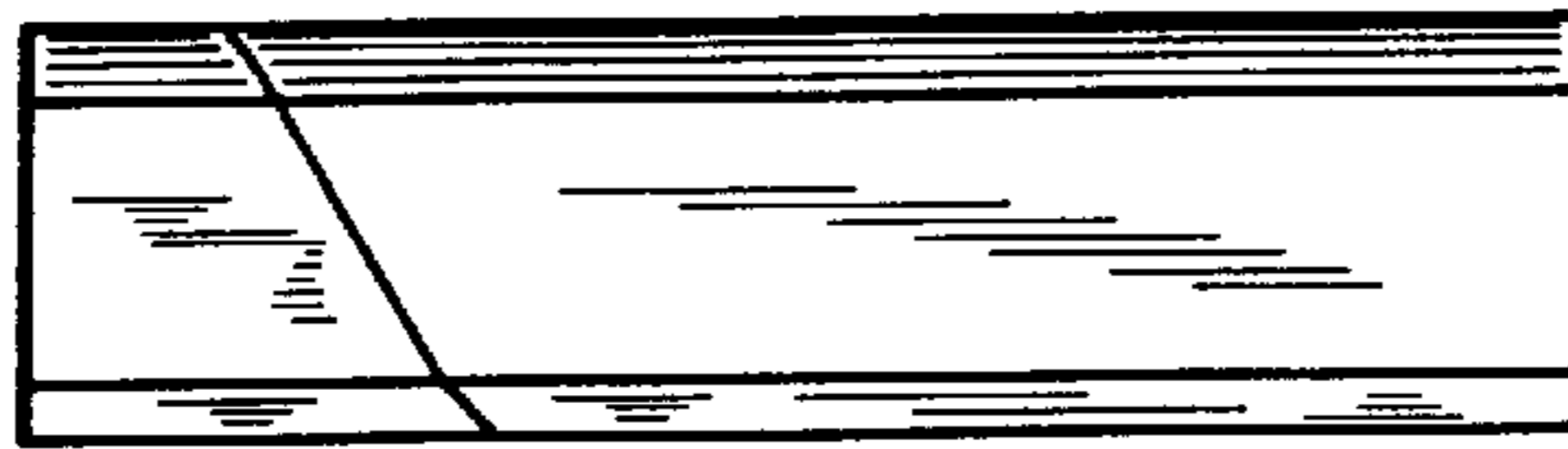

Fig. 3

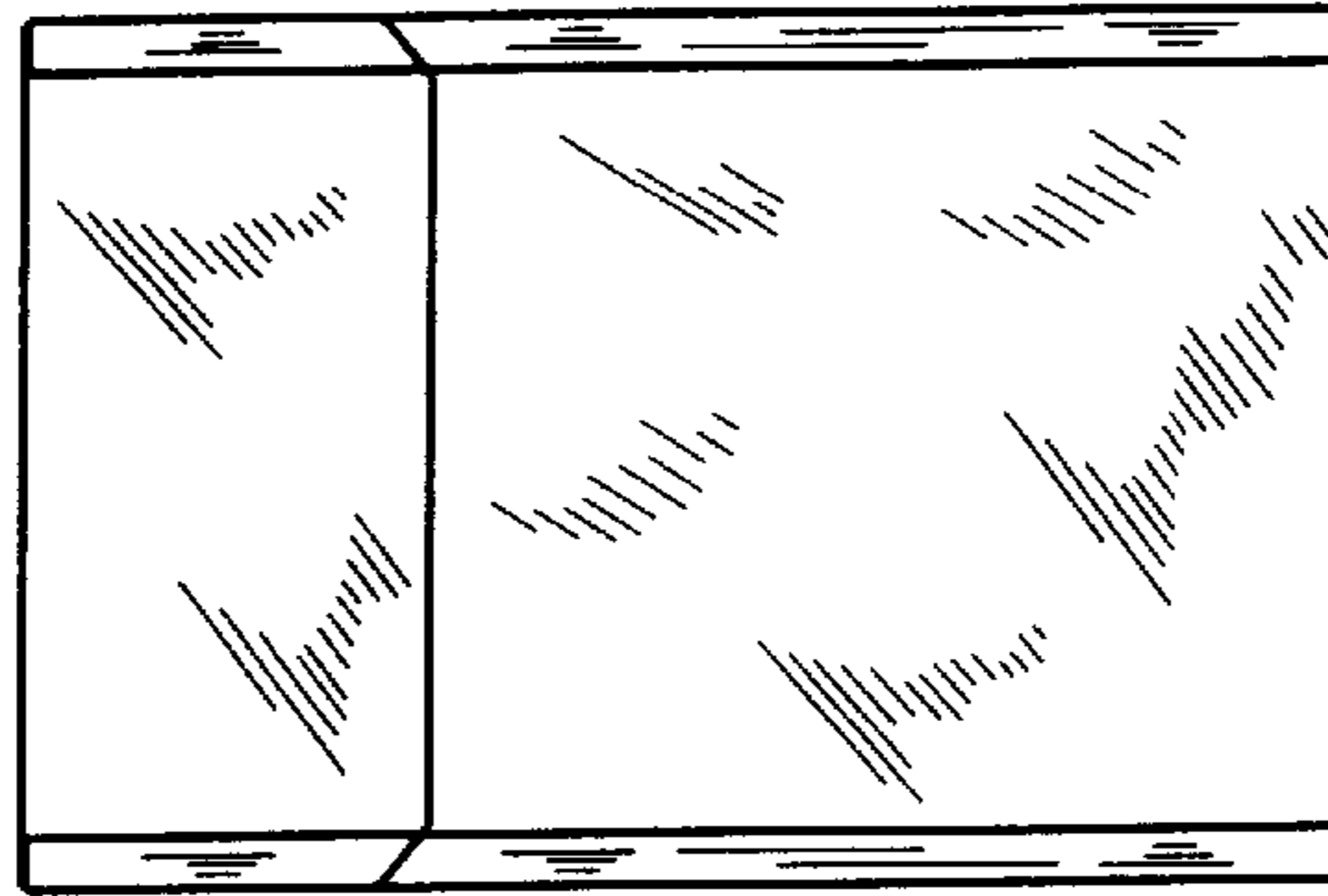

Fig. 4

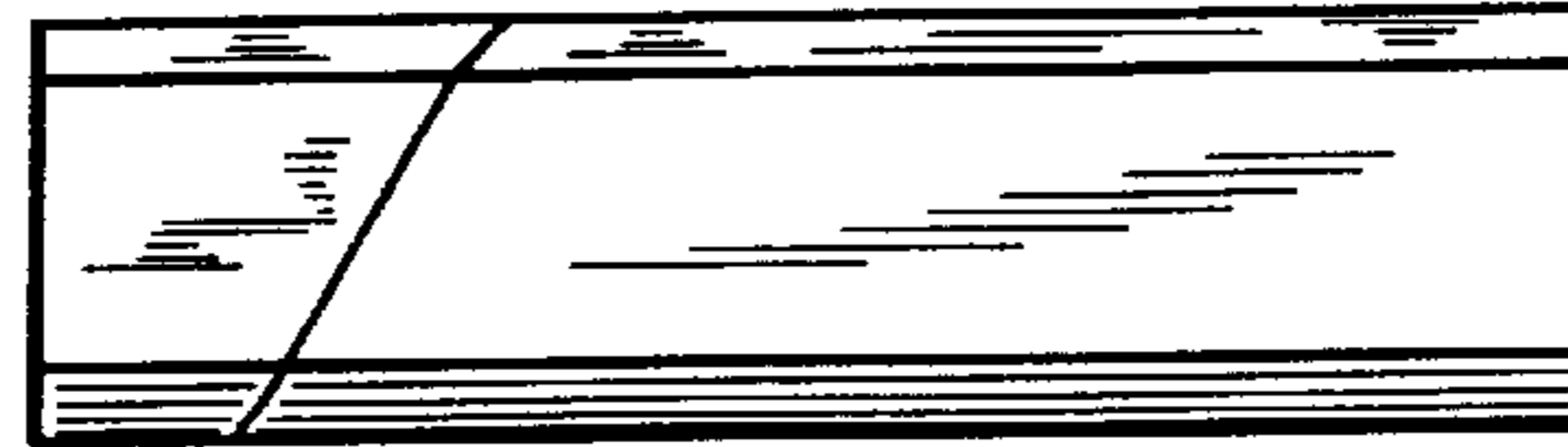

Fig. 6

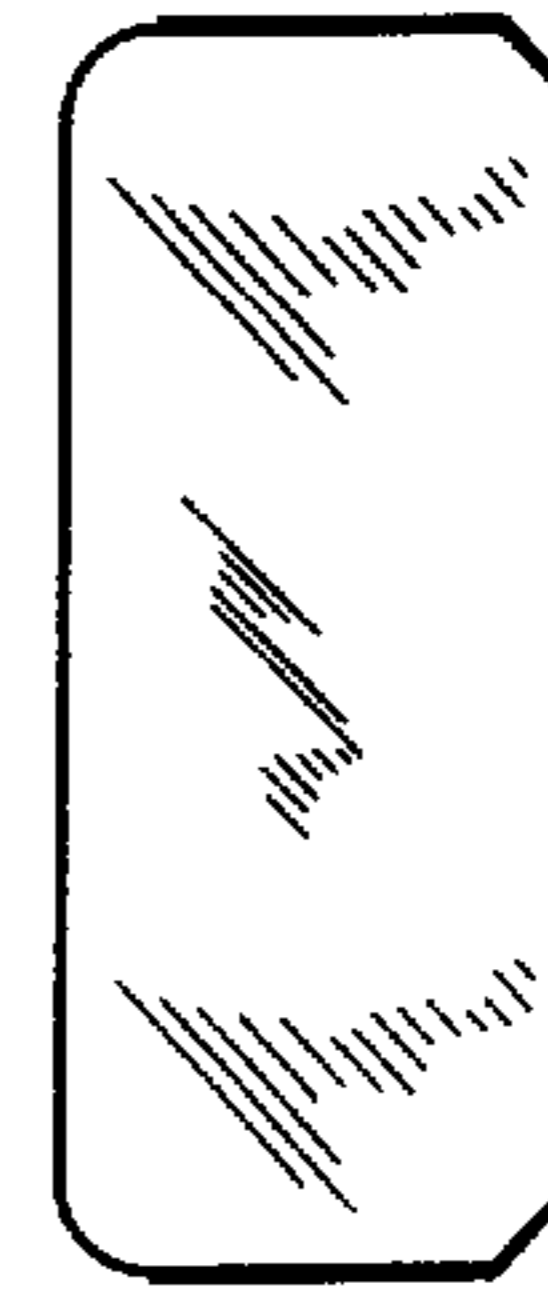
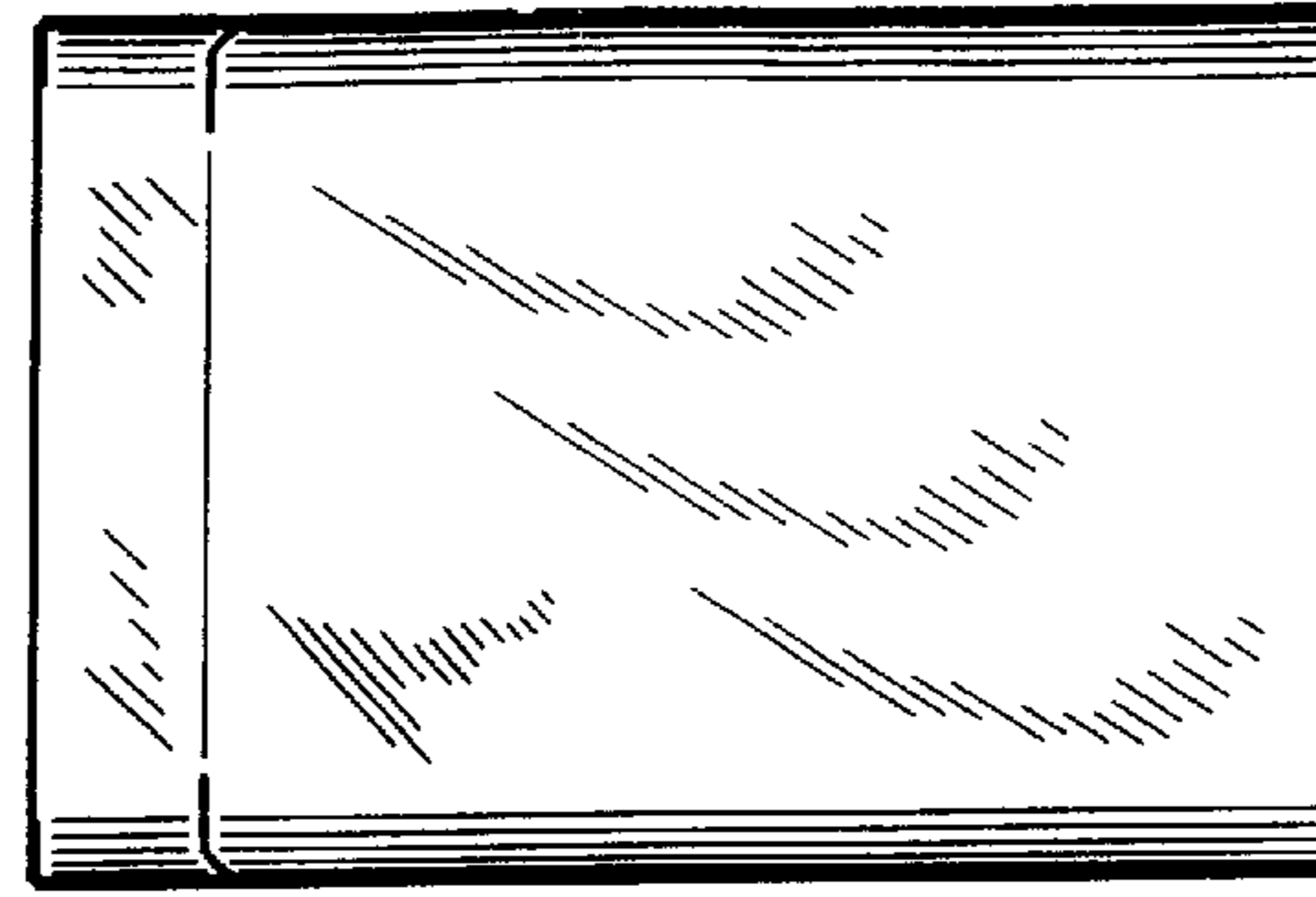

Fig. 5

Fig. 7

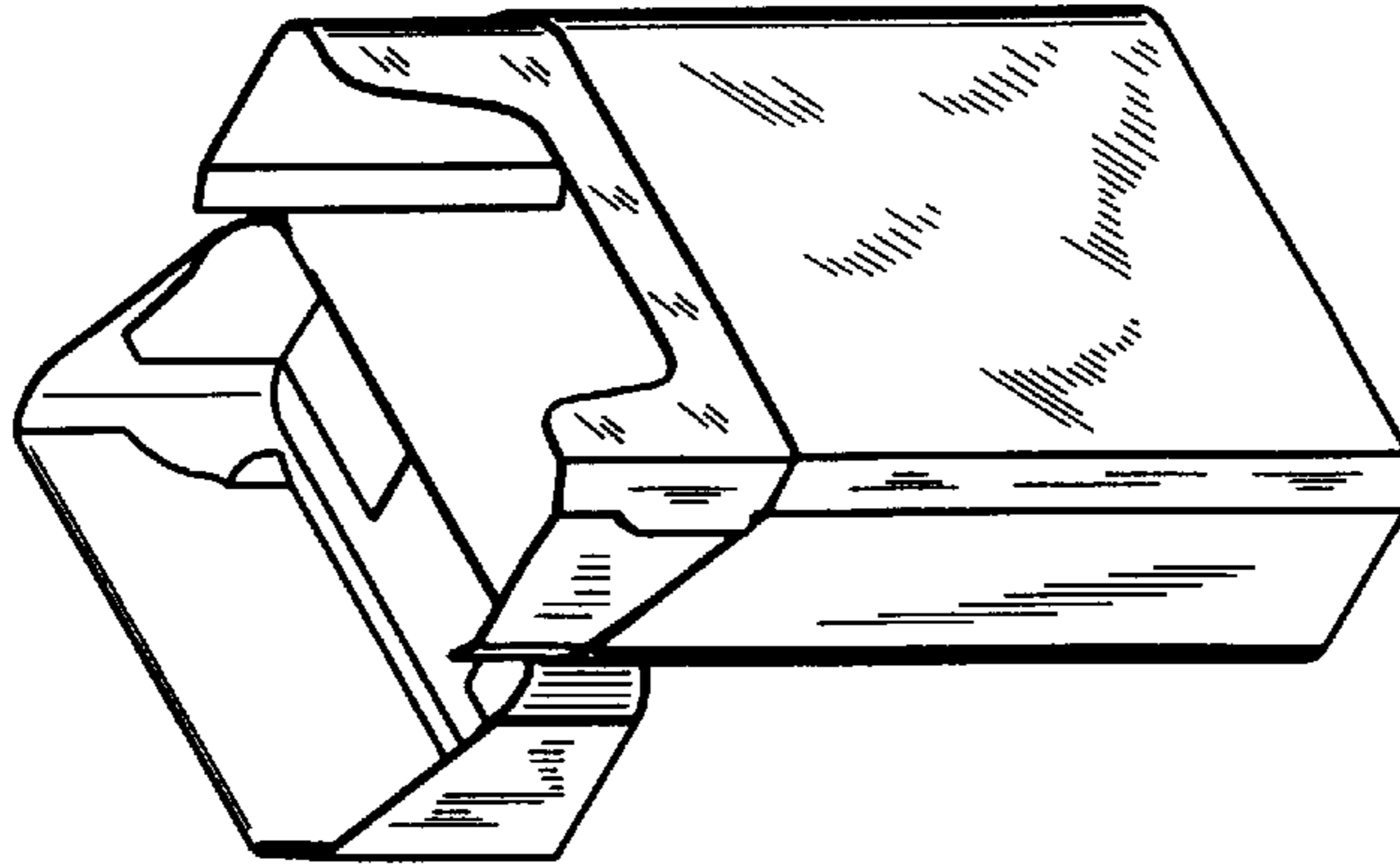

Fig. 8

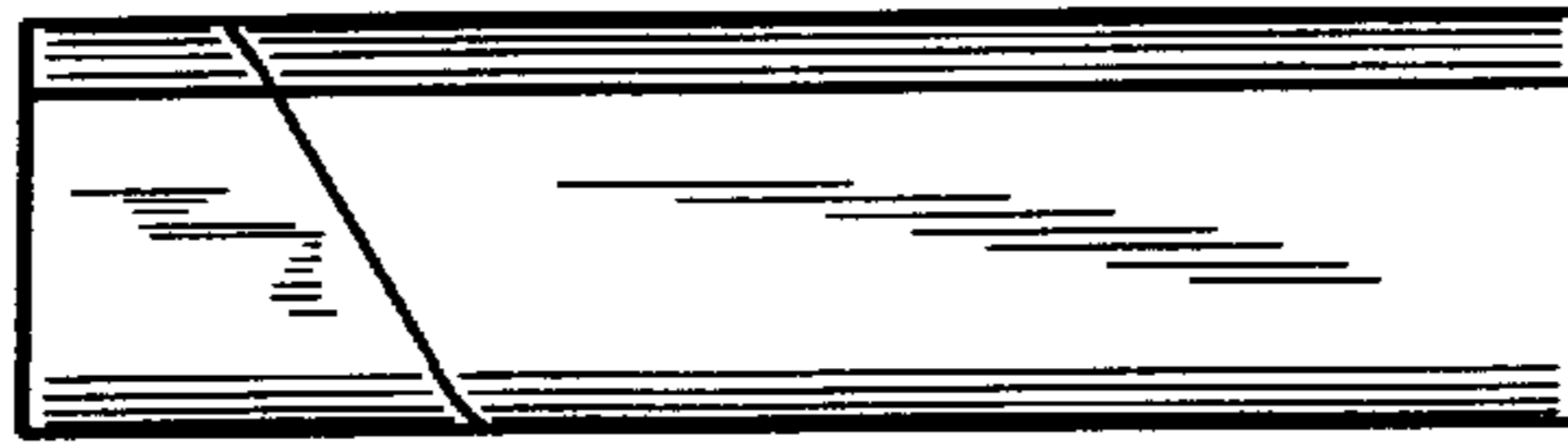

Fig. 9

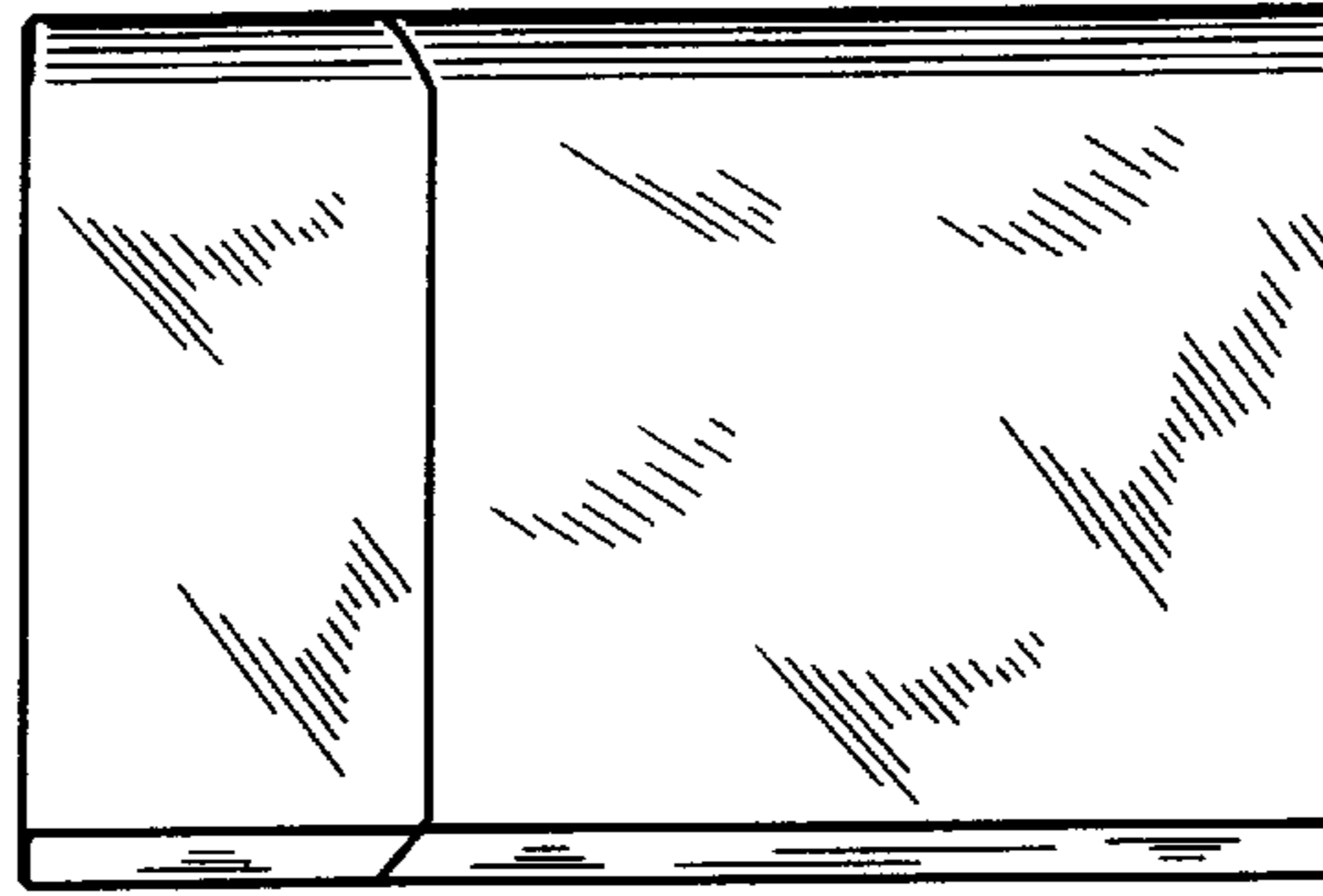

Fig. 10

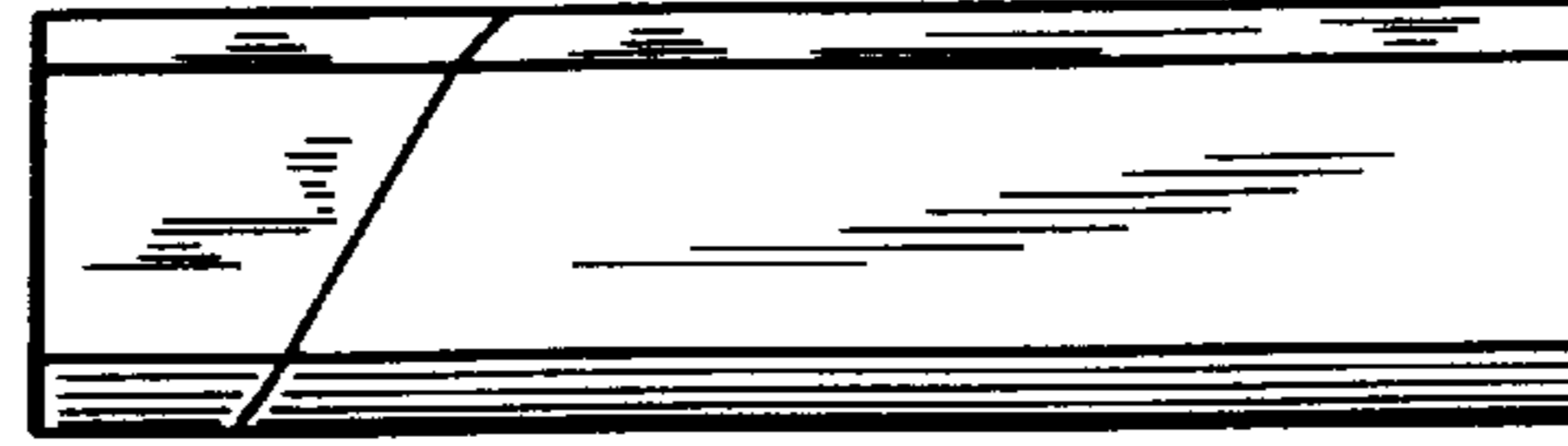

Fig. 12

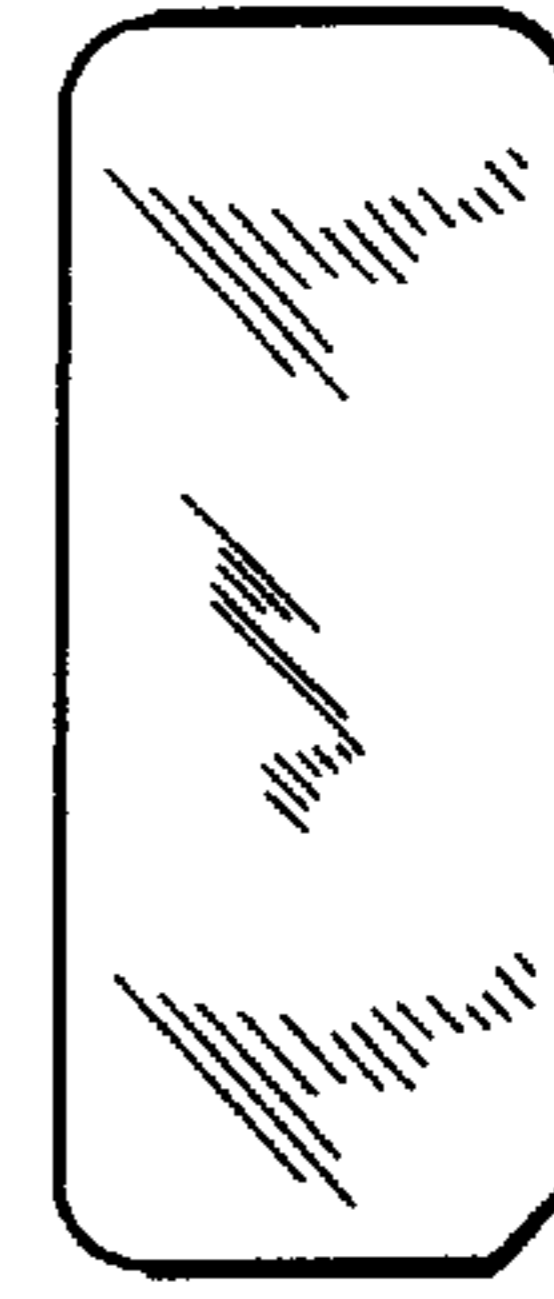
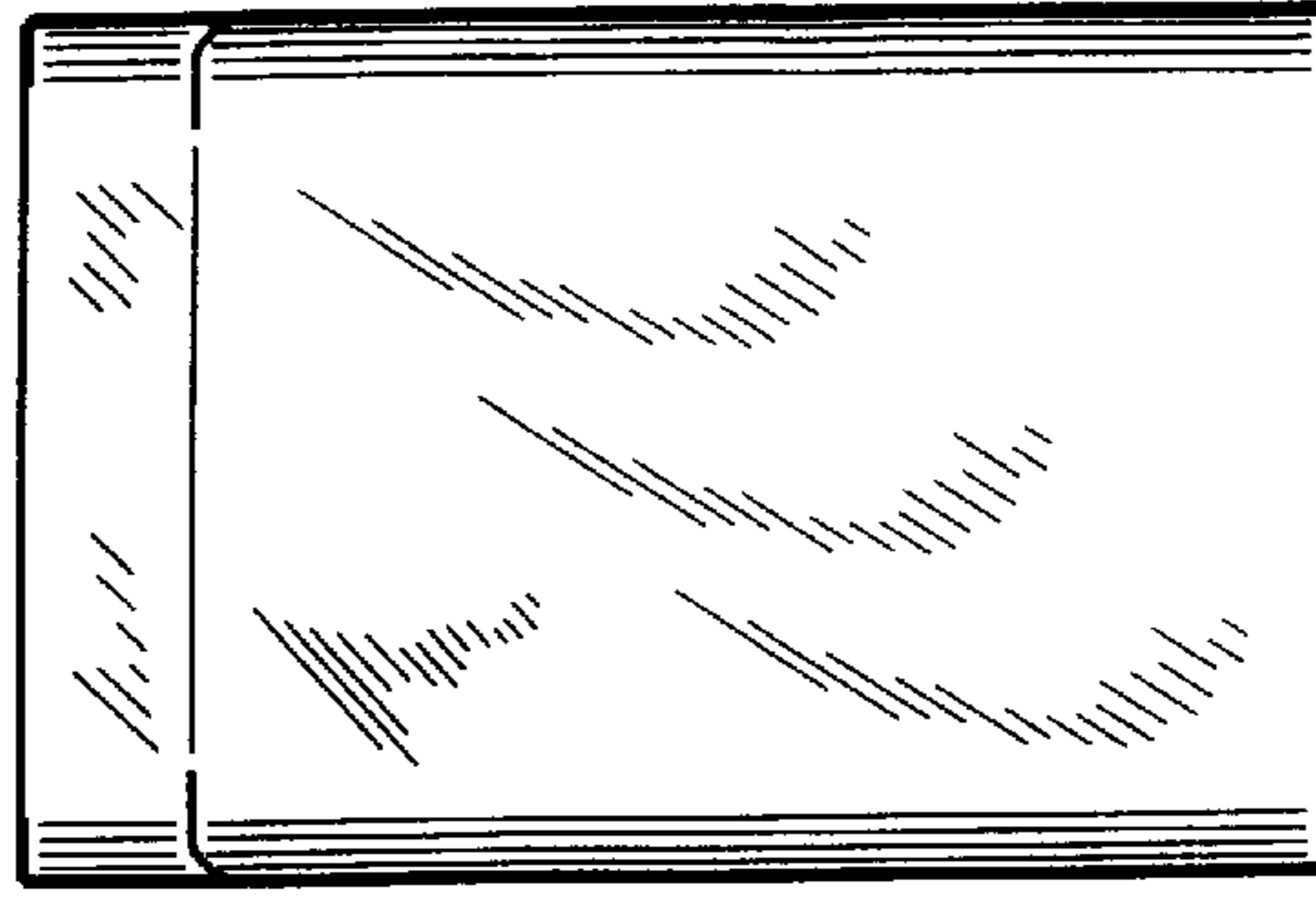

Fig. 11

Fig. 13

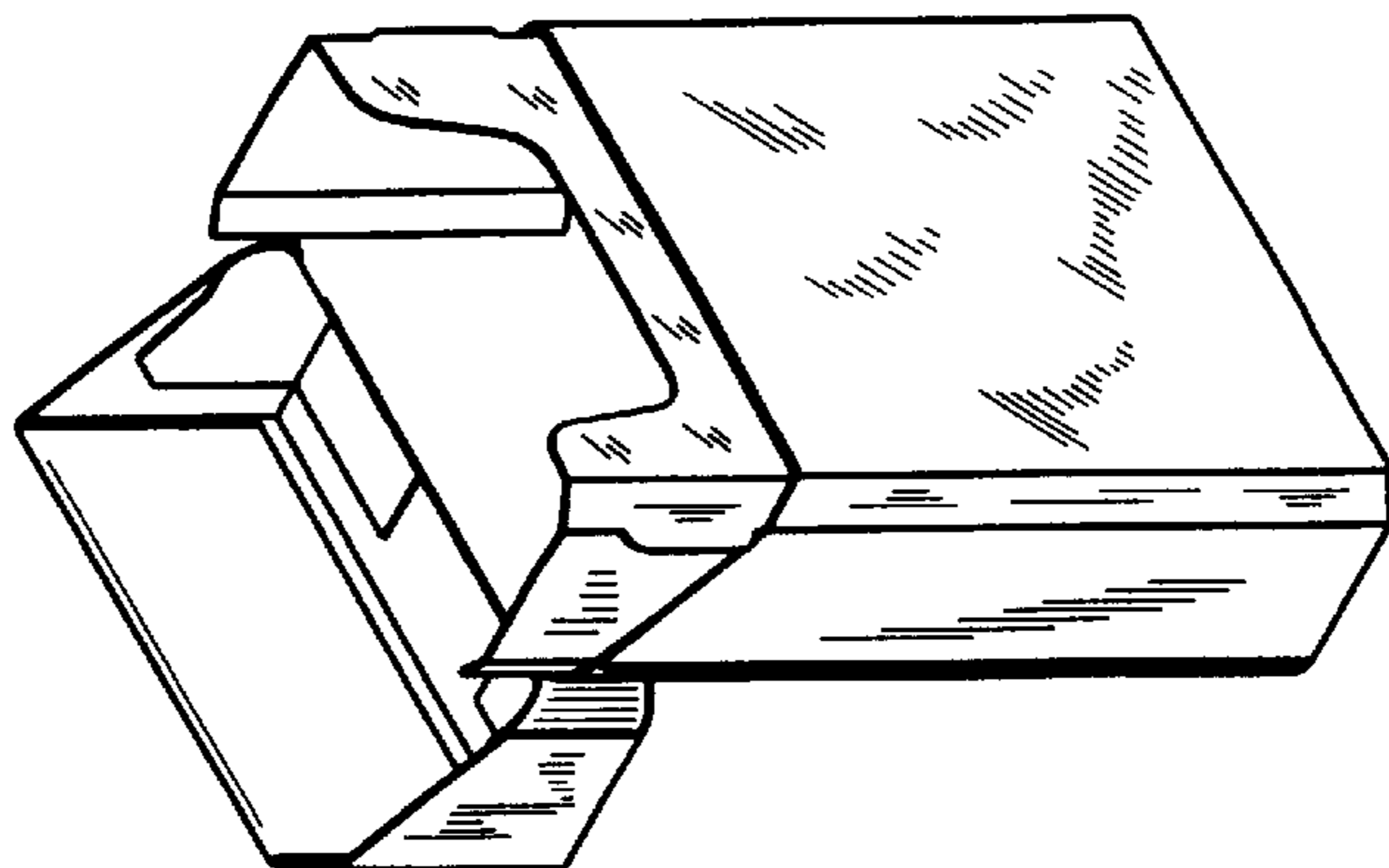

Fig. 14

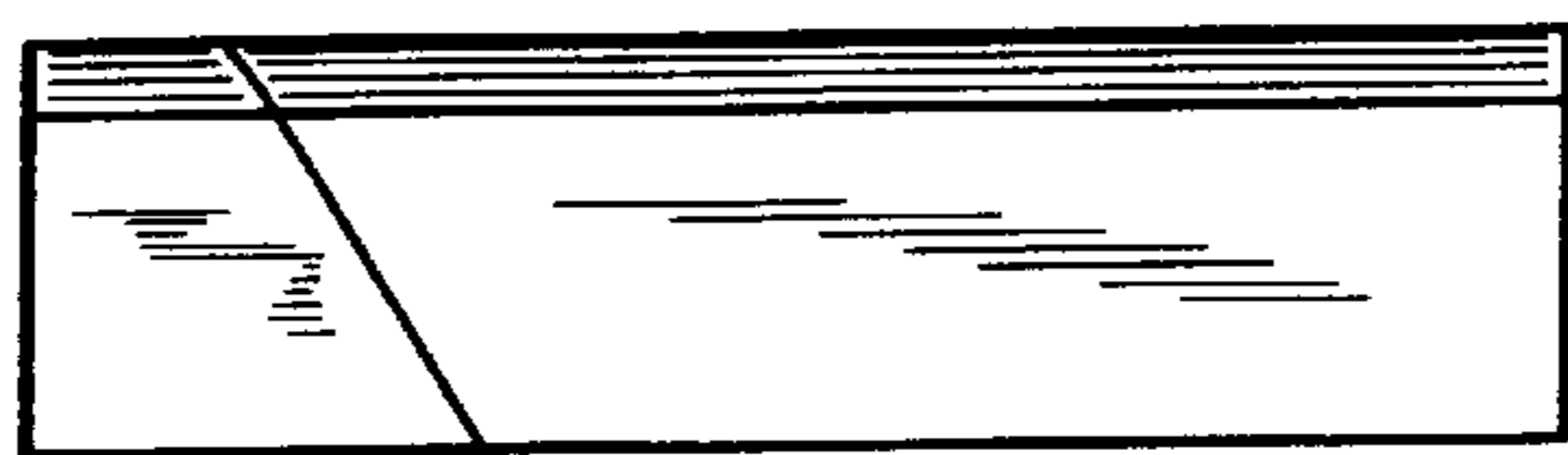

Fig. 15

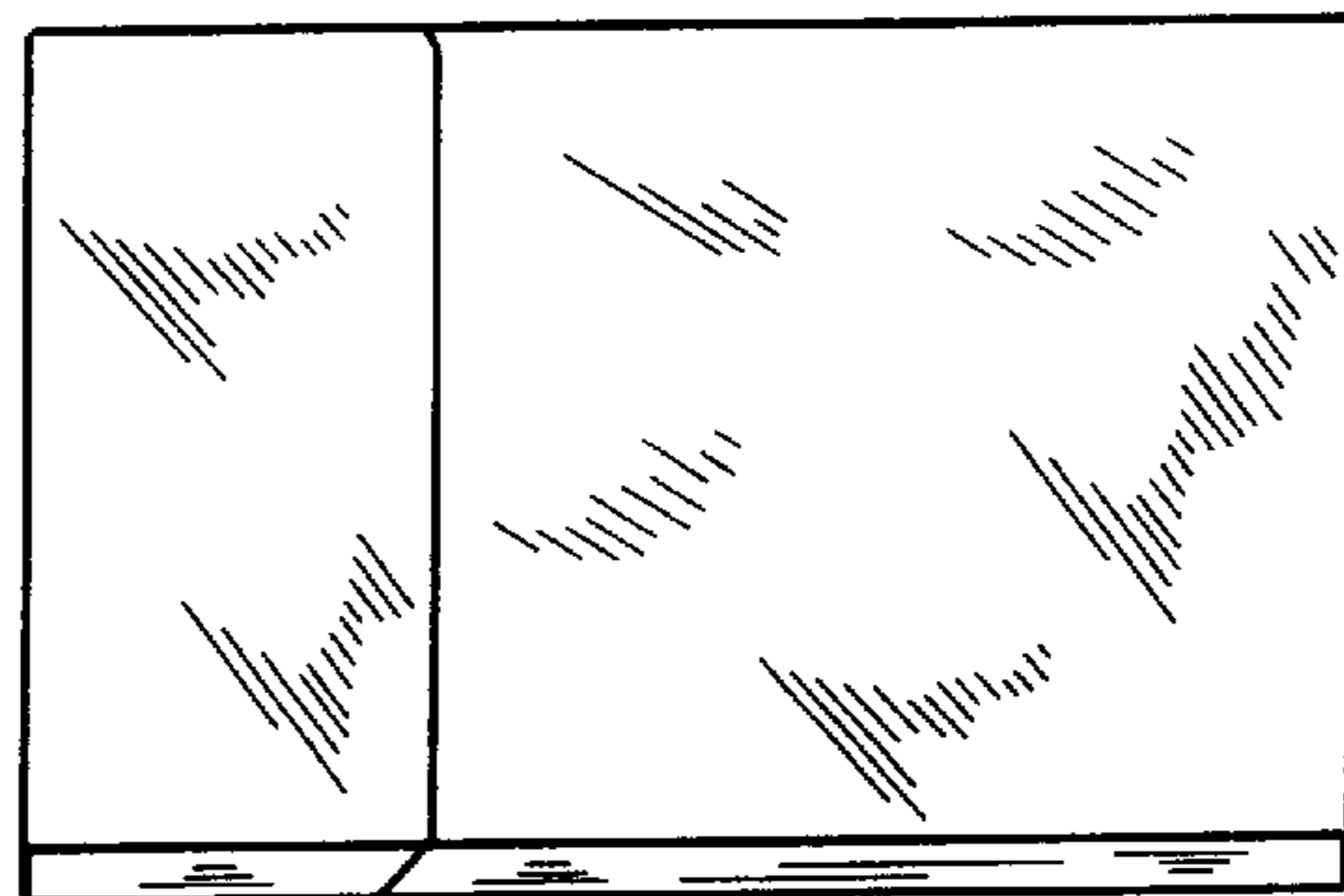

Fig. 16

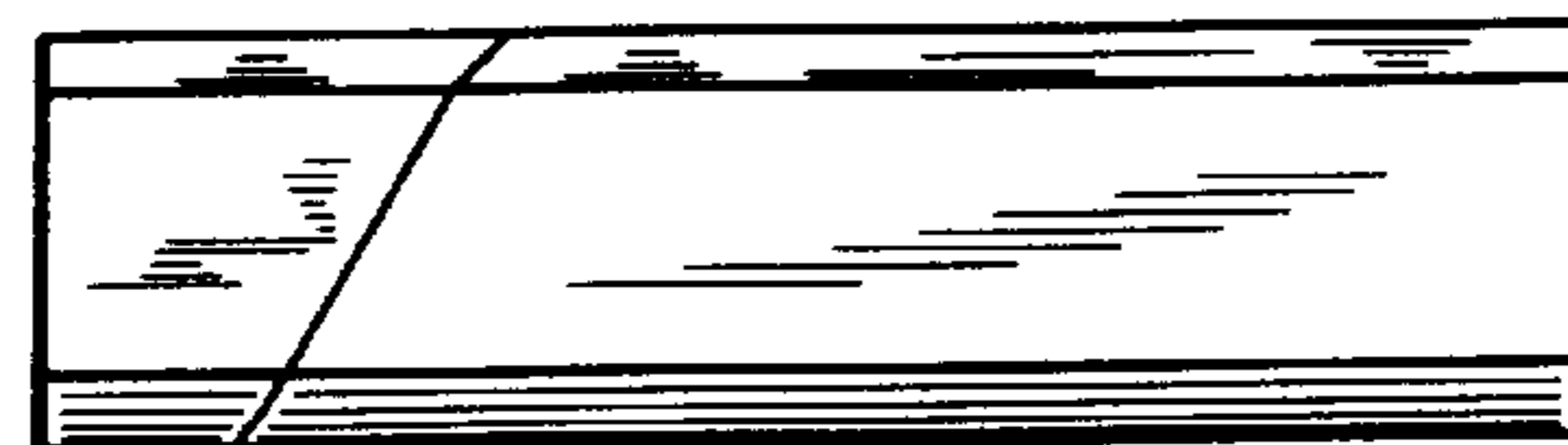

Fig. 18

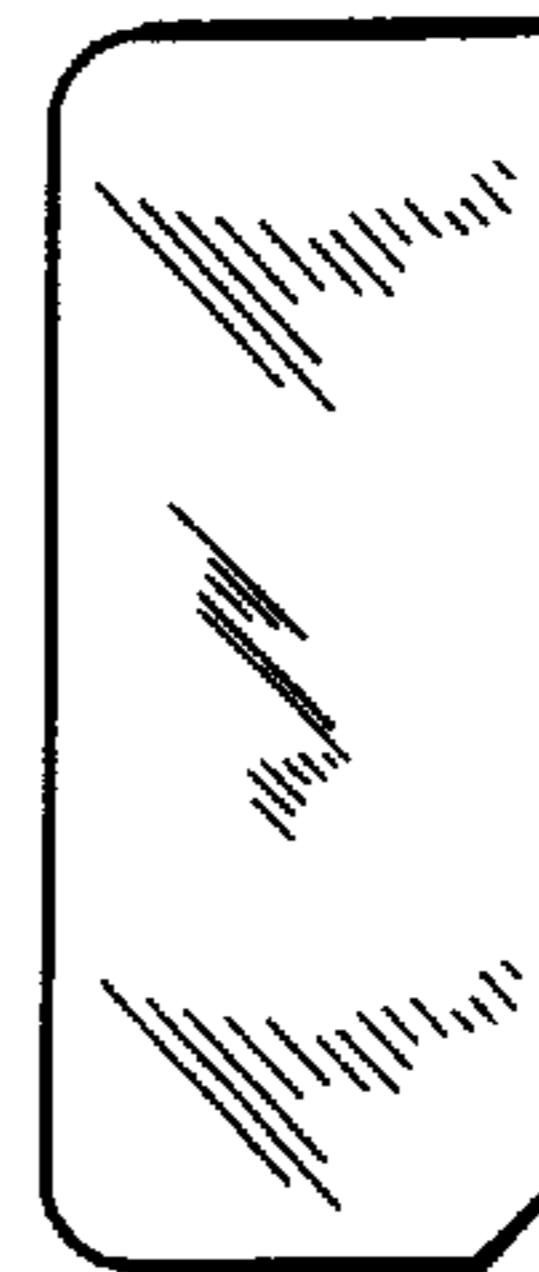
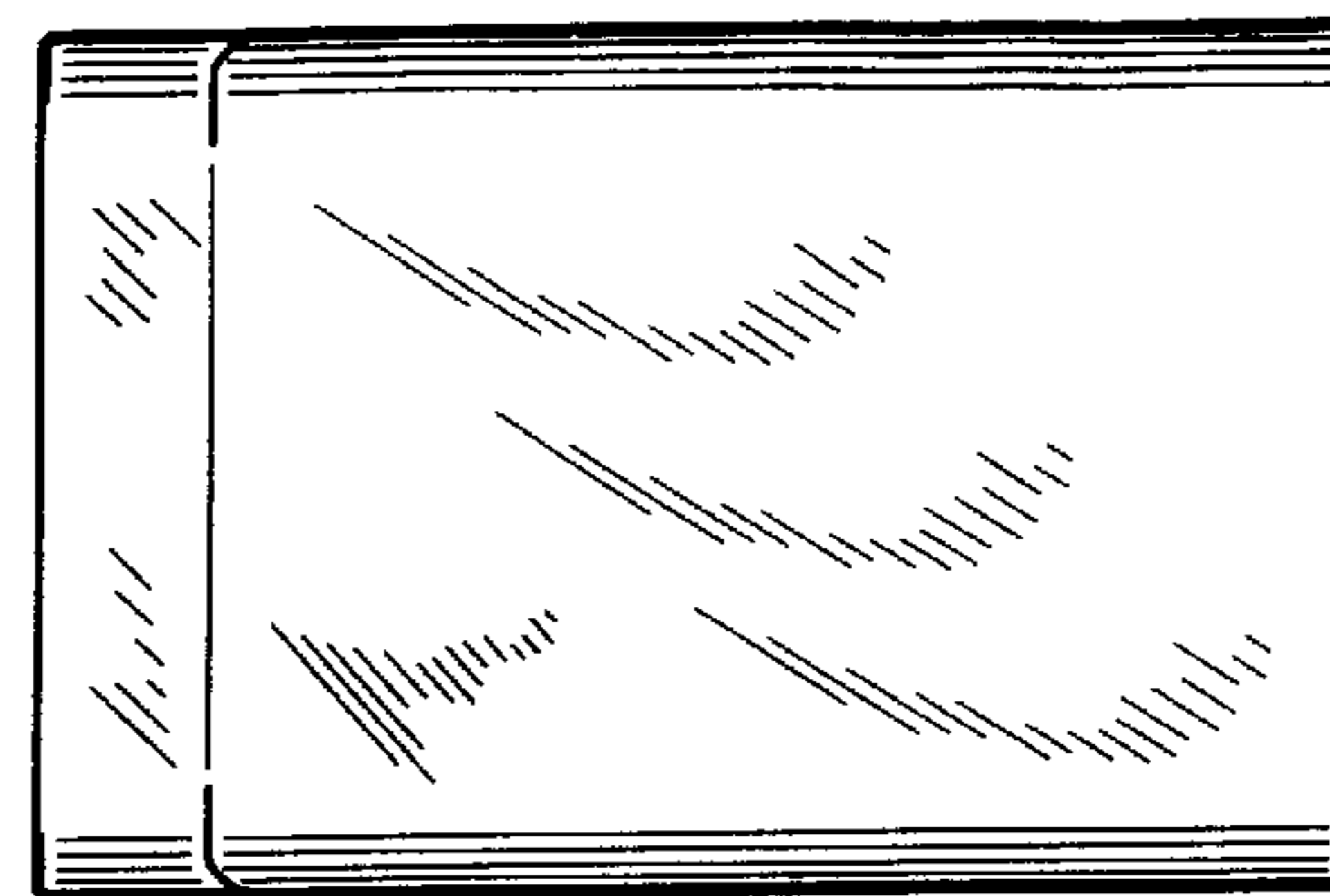

Fig. 17